

**THE
SCIENTIFIC REPORTS
OF
THE WHALES RESEARCH INSTITUTE**

No. 18



ICR

一般財団法人 日本鯨類研究所
THE INSTITUTE OF CETACEAN RESEARCH

THE WHALES RESEARCH INSTITUTE

TOKYO · JAPAN

MARCH 1964

THE WHALES RESEARCH INSTITUTE
12-4, TSUKISHIMA NISHIGASHIDORI,
CHUO-KU, TOKYO



一般財団法人 日本鯨類研究所
THE INSTITUTE OF CETACEAN RESEARCH

THE SCIENTIFIC REPORTS OF THE WHALES
RESEARCH INSTITUTE

CONTENTS OF NUMBER 18

	Page
FUJINO, K. Fin whale subpopulations in the Antarctic whaling areas II, III and IV	1
ICHIHARA, T. Prenatal development of ear plug in baleen whale	29
OHSUMI, S. Examination on age determination of the fin whale	49
NEMOTO, T. School of baleen whales in the feeding areas	89
OKUTANI, T. AND NEMOTO, T. Squids as the food of sperm whales in the Bering Sea and Alaskan Gulf	111
OHSUMI, S. Comparison of maturity and accumulation rate of corpora albicantia between the left and right ovaries in Cetacea	123
OMURA, H. A systematic study of the hyoid bones in the baleen whales	149
NISHIWAKI, M. Revision of the article "Taxonomical consideration on genera of <i>Delphinidae</i> " in No. 17	171
TSUYUKI, H. AND NARUSE, U. Studies on the lipids in brain of black right whale in the northern Pacific Ocean	173

FIN WHALE SUBPOPULATIONS IN THE ANTARCTIC WHALING AREAS II, III AND IV

KAZUO FUJINO

Investigation on identifying breeding populations of wild-life is not only of significance as the first step of the stock assessment for management of the commercially exploited animals in fisheries, but also itself provides the biological bases for the physiological and the ecological studies and for the population genetics. For this purpose, marking investigations which were initiated by the 'Discovery Committee' in 1932 have been succeeded by the National Institute of Oceanography, United Kingdom. This program has been continued under a scheme for the international co-operation since 1953 (Clark & Brown, 1957). Bi-lateral investigations under the immunogenetical concepts were commenced in 1960/61 season (Fujino, 1962).

Reviewing knowledges obtained so far in relation to identification of stocks, major results of marking investigations for the Antarctic fin whales reported by Brown (1954 a, 1954 b, 1962 a and 1962 b) can be summarized as follows. 1) There distribute one or more populations in each area of the Antarctic whaling grounds. 2) Different stocks from separate breeding areas mingle in the feeding grounds each other. 3) The majority do not disperse more than 50° east or west of the positions of marking.

Basing upon the blood typing investigation which was undertaken in the 1960/61 Antarctic whaling season for the first time, Fujino (1962) states that there distribute at least two populations of fin whales which have different incidences of Ju blood types each other in area III and that this support the items 1) and 2) of the results of marking investigations stated above.

When the migratory ranges of different populations overlap each other, situation of problems concerned becomes to be much more complicated. After summarizing results of blood typing study obtained during three seasons from 1960/61 to 1962/63 and of marking investigations undertaken since 1932/33 season, the present paper deals with problems in 1) identifying breeding subpopulations, 2) migratory ranges and rates of intermingling of different populations in the feeding grounds of the Antarctic, and 3) some problems in physiology and in ecology relating to the differences of population.

The author acknowledges co-operation in collecting and transporting blood specimens of inspectors, biologists, and officers and crews of the whaling factory-ships. Staffs of the Kyokuyo Hoge Company kindly offered some detailed logs on their whaling operations. The author would like to express his sincere thanks in using the precious materials which were compiled from a series of publications of Mr. S. G. Brown, National Institute of Oceanography, United Kingdom. Sincere thanks also due to Dr. H. Omura, Director of the Whales Research

Institute who organized extensive collection of bloods, Dr. E. Matsunaga at the National Institute of Genetics and Dr. Y. Nose at the University of Tokyo who gave to the author valuable suggestions and advices.

BLOOD TYPING INVESTIGATIONS

Relative incidences of hereditary characteristics, of which the phenotypes reveal polymorphism, are of worth as genetic marker for identifying isolated breeding populations. Blood type antigen is generally inherited in simple way, so that it is understood to be one of the most useful characters for such analysis. In the present investigation, Ju blood type system was utilized similarly to that in the previous paper (Fujino, 1962)

Materials and Methods

Whale bloods Bloods spout out from the cut at the tip of snout or in the palate or remaining in the heart were collected into 50 ml. plastic bottles. In 1960/61 season, the fresh samples were used for examination which was made on board Kyokuyomaru no. 2. In 1961/62 and 1962/63 seasons, the samples were collected by inspectors boarding on Japanese seven whaling factory ships, and were successively kept frozen until the examination was undertaken at the laboratory of the Whales Research Institute, Tokyo. As shown in Fig. 1, localities, where blood specimens were taken, cover areas II, III and IV, including lower latitudinal portion of area III of north of 50° south. Number of whales examined and their percentages against the catch in each year was shown in Table 1. Approximately 6000 fin whales were

TABLE 1. NUMBER OF BLOOD SAMPLES EXAMINED IN THE THREE SEASONS DURING FROM 1960/61 TO 1962/63

Season	No. of samples examined*	No. of fin whales taken by Japanese fleets	Remarks
1960/61	1,266 (14.2%)	8,912	} Tested for fresh samples ⁺ Tested for preserved samples (Cushing et al., 1959) ⁺⁺
1961/62	2,188 (18.5%)	11,861	
1962/63	2,483 (23.7%)	10,475	
Sum	5,937 (19.0%)	31,248	

* Samples, from which no cells were recovered, are excluded. In addition 21 and 41 whales were examined in 1961/62 and 1962/63 respectively, but no information was given. Numbers of hemolysed samples are 244 and 240 in the seasons 1961/62 and 1962/63 respectively. Figures in parentheses show percentages of samples examined against total catch.

⁺ Examination was made on board Kyokuyomaru no. 2 only.

⁺⁺ Collected by inspectors and biologists boarding on Japanese seven whaling fleets.

examined during the three seasons, and this corresponds 19.0 per cent of the total number of this species taken by Japanese fleets in these periods.

Reagents After being diluted and absorbed, were used the following serums which were prepared by immunizing fowls or rabbits intravenously with Ju1 type or Ju2-positive type erythrocytes of fin whales.

Anti-Ju1 immune fowl serums nos. 47 and 70
 Anti-Ju2 immune rabbit serum no. 34
 Anti-Ju2₁ immune rabbit serum no. 61
 Anti-Ju2₅ immune rabbit serum no. 65

A part of each serum of no. 47 and no. 34, being prepared by injecting the erythrocytes of the north Pacific fin whales, had been used in the previous investigations (Fujino, 1960 & 1962). Serums nos. 61, 65 and 70 were prepared by immunizing with erythrocytes of the Antarctic fin whales which were taken in 1961/62 season and were successively stored by glycerol-freezing (Cushing et al., 1959).

Testing methods Test-tube method and slide-glass method were used for blood typing tests. To treat the large numbers of specimens taken in the 1961/62 and 1962/63 seasons efficiently, were made the following procedures. At first, all samples obtained during one whaling season were tested by 1:10 diluted anti-Ju2 no. 34 or 1:10 diluted anti-Ju2₅ no. 65 serums which were in advance sufficiently absorbed with Ju1 cells. After being classified into Ju1 and Ju2-positive groups by these tests, the samples of the latter group were subdivided into sub-specificities of Ju2 antigen complex, and were successively identified as heterozygous or homozygous types.

Reagents for subtyping five specificities in Ju2 antigen complex were prepared by absorbing nos. 34 and 61 serums with various subtypes of erythrocytes. A part of these absorbed reagents, being used for testing 1961/62 samples, were kept frozen for about one year to be used for 1962/63 samples.

Classification and Genetics of Ju Blood Groups

In the previous paper, Fujino (1962) states that bloods of the Antarctic fin whales can be classified into three major types of Ju1 homozygote, Ju1·2 heterozygote, and Ju2 homozygote similarly to those of this species in the North Pacific

TABLE 2. FIN WHALE JU BLOOD TYPES CLASSIFIED BY SIX KINDS OF ANTISERA*

Specificity of reagents**	<i>Ju1</i> homozygote**	<i>Ju1·2</i> heterozygotes**					<i>Ju2</i> homozygotes**				
	1***	1·2 ₁	1·2 ₂	1·2 ₃	1·2 ₄	1·2 ₅ ***	2 ₁	2 ₂	2 ₃	2 ₄	2 ₅ ***
Anti-Ju1	+	+	+	+	+	+	-	-	-	-	-
Anti-Ju2 ₅	-	+	+	+	+	+	+	+	+	+	+
Anti-Ju2 ₄	-	+	+	+	+	-	+	+	+	+	-
Anti-Ju2 ₃	-	+	+	+	-	-	+	+	+	-	-
Anti-Ju2 ₂	-	+	+	-	-	-	+	+	-	-	-
Anti-Ju2 ₁	-	+	-	-	-	-	+	-	-	-	-

* Cited from Fujino (1963b).

** Major three types.

*** Eleven types subdivided by five specificities of Ju2 antigen complex.

by agglutination with the anti-Ju1 and the anti-Ju2 reagents, including three subtypic specificities in each group of the latter two. Large scale collection of frozen samples in 1961/62 season made it possible to make further detailed analysis by

repeated tests, and led to subdivide Ju2 antigen complex into five specificities. Then the blood types of this species amount to eleven kinds in all as shown in Table 2.

Table 3 shows differential partial agglutinin titres between immune serums nos. 65 and 61 after being absorbed with various types of erythrocytes. Anti-Ju₅ no. 65 serum absorbed with Ju1 type erythrocytes agglutinates Ju1·2₁ type cells up to dilution 1 : 320 and Ju1·2₅ type cells up to 1 : 40, and the relative highest dilution against these two different subtypes of cells is only 8 : 1. On the other hand, anti-Ju₁ no. 61 serum absorbed with Ju1 type cells agglutinate Ju1·2₁ cells up

TABLE 3. AGGLUTININ TITRES AGAINST SUBTYPIC PARTIAL SPECIFICITIES IN DIFFERENT IMMUNE SERUMS

a) Anti-fin Ju₅ serum (No. 65)

cells of no. type	unabsorbed						abs. by Ju1 cells (2K 270)						abs. by Ju1·2 ₅ cells (3K 70)		
	10	20	40	80	160	320	10	20	40	80	160	320	5	10	20
2K 270 Ju1	+	-	-	-	-	-	-	-	-	-	-	-	-	-	-
3K 70 Ju1·2 ₅	###	##	++	+	-	-	##	++	+	-	-	-	-	-	-
3K 148 Ju1·2 ₄	##	##	###	++	+	-	##	++	++	+	-	-	-	-	-
3K 83 Ju1·2 ₃	##	##	##	##	++	+	##	##	++	+	-	-	-	-	-
3K 127 Ju1·2 ₂	##	##	##	##	++	+	##	##	##	++	+	-	-	-	-
3K 12 Ju1·2 ₁	##	##	##	##	##	++	##	##	##	##	++	+	-	-	-

b) Anti-fin Ju₁ serum (No. 61)

cells of no. type	unabsorbed						abs. by Ju1 cells (2K 270)						abs. by Ju1·2 ₅ cells (3K 127)						
	10	20	40	80	160	320	2	5	10	20	40	80	160	10	20	40...	1280	2560	
2K 270 Ju1	+	+	-	-	-	-	-	-	-	-	-	-	-	-	-	-	...	-	-
3K 70 Ju1·2 ₅	++	+	-	-	-	-	++	+	-	-	-	-	-	-	-	-	...	-	-
3K 148 Ju1·2 ₄	##	++	+	-	-	-	##	++	+	-	-	-	-	-	-	-	...	-	-
3K 83 Ju1·2 ₃	##	##	++	+	-	-	##	##	++	+	-	-	-	-	-	-	...	-	-
3K 127 Ju1·2 ₂	##	##	##	++	++	+	##	##	##	++	+	+	-	-	-	-	...	-	-
3K 12 Ju1·2 ₁	##	##	##	##	##	##	##	##	##	##	##	##	##*	##	##	##	...	++	+

* Positively agglutinated up to dilution 1 : 2560.

to dilution 1 : 2560 and Ju1·2₅ cells up to 1 : 5, and the relative titre reveals marked difference. According to these observations, it was noticed that degree of dilution of the latter serum (no. 61) should be carefully adjusted to avoid mistyping Ju₂₅ or Ju₂₄ specificities of cells into Ju₂-negative types.

As regards the allelic system of Ju blood groups of the Antarctic fin whales, Fujino (1962) states that no significant difference was seen in the relative incidences of the major three blood types between the observed and the calculated figures expected from two equal allelic system. Table 5 shows the observed and the calculated (parenthesized) figures of frequency of occurrence of the major three types for each population which are expected from the allelic system noted above. Both these figures are well consistent each other, and this might support the hypothesis proposed.

Relative Incidences of Blood Types and Stock Identification

Existence of local subpopulations as shown by geographical non-random distribution of blood types In 1960/61 season localities, where blood typing investigation was made, cover mostly the southern part of 50° south of area III ranging from 0° to 70° east (Fujino, 1962). In the successive two seasons, further informations were added for this area, and the investigations were extended to the lower-latitudinal portion of area III of north of 50° south, eastern portion of area II, and western portion of area IV (Fig. 1). Table 4 shows the summary of relative incidences of the major three blood types for different localities obtained during the successive three seasons. 'Lower latitude' of area III in this table correspond the portion north of 50° south ranging from 20° to 50° east. Most samples (83.3 per cent) of area II were obtained from a sector ranging from 0° to 10° west. It can be seen from this table that percentage incidences of Ju2-positives (sum of Ju1·2 heterozygote and Ju2

TABLE 4. NON-RANDOM GEOGRAPHICAL DISTRIBUTION OF JU MAJOR BLOOD TYPE INCIDENCES IN THE AREAS II, III AND IV*

Major blood types	Area II***	Area III		Area IV	Sum
		High. latitude	Low. latitude**		
Ju1	692	3,323	889	704	5,608
Ju1·2	48	194	33	32	307
Ju2	4	16	1	1	22
Sum	744	3,533	923	737	5,937
% of Ju2-positives	7.0	5.9	3.7	4.5	5.5

* Summarized data obtained during from 1960/61 to 1962/63.

** North of 50°S, 20°E to 50°E.

*** 620 samples out of these were taken from a sector of 0° to 10° W.

homozygote) reveal the geographical cline in order of area II > southern part of 50° south of area III > area IV > northern part of 50° south of area III. This fact suggests that the fin whales which distribute in these areas do not belong to one homogeneous stock, but rather consist of at least two or more populations that have differential incidences of the blood types each other.

As noted in the previous paper, percentage incidence of Ju2-positive types reveals generally to be low figure of approximately 2 percent in the southern part of 50° south of area III, representing that of a population of which the major stock distributes in area III. Though previously being called as the aboriginal population in area III, this may be more appropriately named as the West Indian population. Superimposed upon the usual daily frequency of occurrence, sharp upward fluctuations in the take of Ju2-positive whales in the south-western portion of area III occurred in an intermittent series of days, and the upper limit of Ju2-positive incidence was estimated from the daily incidences as a constant figure of approximately 30 per cent. These whales were interpreted to represent a part of the Atlantic population which migrates eastwards in the previous paper by basing upon knowledges of marking returns (Brown, 1954). Figures of Ju2-positive incidences

of 30.7 per cent for the Atlantic population in Table 5 were drawn by summarizing data of days when incidence of Ju2-positive types jumped up markedly as noted above. In the west portion of area IV, Ju2-positive incidence reveals nearly the same figure as that of the West Indian population, but upwards fluctuations were observed in some days. Although these are not so marked as those in the case of mingling with the Atlantic population, this fact show that another population, which has some higher incidence of Ju2-positive types than that of the West Indian population and may be named as the East Indian population, distributes in this area. There can be seen some inconsistency in the estimates of the incidence of Ju2-positives between the results of both years in 1961/62 and 1962/63, which might

TABLE 5. FREQUENCIES OF OCCURRENCE OF JU MAJOR BLOOD TYPES IN EACH PURE POPULATION*

Major blood types	Atlantic population	Lower latitudinal population	West Indian population	East Indian population		
				1961/62	1962/63	Sum
Ju1	278 (276.2)	41 (41.8)	913 (910.9)	370	86	456 (456.2)
Ju1.2	109 (114.2)	19 (17.4)	21 (23.9)	13	6	19 (18.6)
Ju2	15 (11.6)	1 (1.8)	1 (0.2)	0	0	0 (0.2)
Sum	402	61	935	383	92	475
% of Ju2-positives	30.7	32.8	2.4	(3.4)	(6.5)	4.0

Remark, Figures in parenthesis show those expected from hypothetical major two equal allelic system.

* Summarized from data of days when whales belonging to each pure population were postulated to be taken in the seasons during from 1960/61 to 1962/63.

be derived from errors in summarizing the data, because they were taken from the localities where two different populations mingle each other. Actual figure for this population might be about 4.0 per cent of average for both seasons or higher. Precise estimation for this figure could be made by extending the investigation to the eastern portion of area IV where pure East Indian population may distribute.

In the lower latitude of area III also daily incidence of Ju2-positive types jumped up significantly in an intermittent series of days against the lower percentages of the backgrounds of the West Indian population. Ju2 incidence being summarized from data of these days is more than 30 percent which is shown as the figure for the 'Lower latitudinal population' in Table 5. The Ju2-positive types incidence is close to that of the Atlantic population noted above, but these two groups of whales can be distinguished by the differential Ju2 subtypic incidences.

As shown in Table 6, relative incidences of Ju2₁ antigen among total Ju2-positives which can be definitely distinguished by its specificity and the strongest reactivity with reagents from other Ju2-positives are 33.7 per cent (35 out of all 104 Ju2 positives) for the Atlantic population and 50 percent (21 out of all 42 Ju2-positives) for the Lower latitudinal population, the difference can be accepted to be significant. In Table 6, it is also characteristic that no Ju2₁ antigen has been found in the East Indian population. Thus it became to be obvious that the four different breeding populations distribute in areas II, III and IV. These might support the results of marking investigations described by Brown (1954 a, 1954 b, 1962 a, &



Fig. 1. Geographical areas II, III and IV where blood typing investigations were undertaken in the three seasons during from 1960/61 to 1962/63. Four circles summarize data given in the text and Table 5. Black sectors correspond relative incidences of total Ju₂-positive whales for the Atlantic, the aboriginals of areas III (West Indian), the aboriginals of area IV (East Indian), and the Lower latitudinal populations. Small circles, triangular spots, and crosses show the localities (noon positions of factory-ships) where whales belonging to the Atlantic, the Lower latitudinal, and the East Indian populations were taken respectively.

1962 b), however, in which no remark was given for the existence of the Lower latitudinal population.

TABLE 6. DIFFERENTIAL FREQUENCIES OF OCCURRENCE OF SUBTYPES IN JU2 ANTIGEN COMPLEX CONFIRMING EXISTENCE OF DIFFERENT POPULATIONS*

Ju2-subtypic specificities	Atlantic population	Lower latitudinal**	West Indian**	East Indian**
Ju2 ₁	35	21	19	0
Ju2 ₂	21	2	11	9
Ju2 ₃	9	7	9	5
Ju2 ₄	16	3	10	6
Ju2 ₅	23	9	21	4
Sum	104	42	70	24

* Summarized results of 1961/62 and 1962/63 seasons.

** Including data of days when whales belonging to both of different populations were taken.

Direct evidences showing overlaps of migratory ranges of different populations in feeding grounds
 Basing upon results of marking investigations, Brown (1962 a) states that in the Antarctic feeding grounds, whales from two separate breeding areas are to be found in

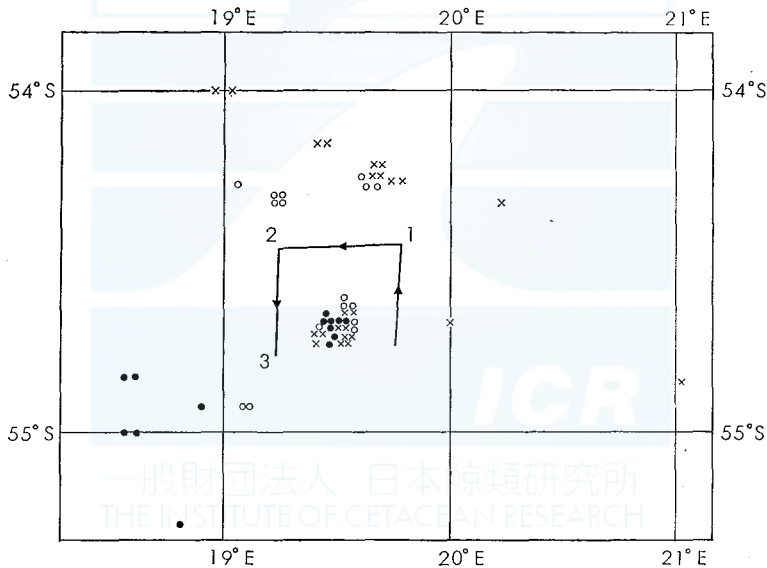

Fig. 2. Evidences showing mixing of the different populations in the feeding grounds as revealed by data of days when whales belonging to both the Atlantic and the West Indian populations were taken in a day. Population differences of whales grouped by three localities where whale carcasses were gathered, drawn by basing upon the logs in Feb. 23, 1961. Concrete lines with arrow show wakes of factory-ship. Three points with Nos. 1, 2 and 3 mean localities where factory ship gathered whales taken. Crosses, open and closed circles mean localities of capture of individual whales belonging to groups Nos. 1 (West Indian population), 2 and 3 (Atlantic population) respectively. (See Table 7).

association in summer, and Fujino (1962) also states that a portion of the Atlantic population from area II migrates to area III and mingles with the population there by basing on the immunogenetical study. No description, however, on direct evidences for overlapping of migratory ranges of different populations has been given. Detailed informations in some days when the whales belonging to both the Atlantic and the West Indian populations were taken might serve as the direct proof for intermingling of different populations in feeding grounds. Fig. 2 shows localities of capture for 54 whales taken by one fleet in Feb. 23, 1961. Carcasses of these whales were successively gathered at three points nos. 1, 2 and 3 on the wake of the factory-ship shown by concrete lines. Some remarks on these three groups of whales are given in Table 7. Number of Ju2-positive whales were

TABLE 7. LOG OF FEB. 23, 1961 SHOWING OVERLAPS OF MIGRATORY RANGES OF DIFFERENT BREEDING POPULATIONS

Locality no., gathering whales captured	Time of capture	No. of whales captured	Blood type incidences		Populations' belonging to	Group-composition																																										
			Ju1	Ju2-positives																																												
1	6.55- 12.45*	24	23	1	West Indian population	<table style="display: inline-table; vertical-align: middle;"> <tr> <td rowspan="2" style="font-size: 2em; vertical-align: middle;">{</td> <td>male</td> <td>13</td> <td>imm.</td> <td>2</td> </tr> <tr> <td></td> <td></td> <td>mat.</td> <td>11</td> </tr> <tr> <td rowspan="2" style="font-size: 2em; vertical-align: middle;">{</td> <td>female</td> <td>11</td> <td>imm.</td> <td>1</td> </tr> <tr> <td></td> <td></td> <td>mat.</td> <td>10</td> </tr> <tr> <td colspan="2"></td> <td></td> <td></td> <td></td> <td style="font-size: 2em; vertical-align: middle;">{</td> <td>preg.</td> <td>4</td> </tr> <tr> <td colspan="2"></td> <td></td> <td></td> <td></td> <td></td> <td>ovul.</td> <td>0**</td> </tr> <tr> <td colspan="2"></td> <td></td> <td></td> <td></td> <td></td> <td>rest.</td> <td>6</td> </tr> </table>	{	male	13	imm.	2			mat.	11	{	female	11	imm.	1			mat.	10						{	preg.	4							ovul.	0**							rest.	6
{	male	13	imm.	2																																												
			mat.	11																																												
{	female	11	imm.	1																																												
			mat.	10																																												
					{	preg.	4																																									
						ovul.	0**																																									
						rest.	6																																									
2	10.35- 20.20	16	10	6	Atlantic population	<table style="display: inline-table; vertical-align: middle;"> <tr> <td rowspan="2" style="font-size: 2em; vertical-align: middle;">{</td> <td>male</td> <td>16</td> <td>imm.</td> <td>2</td> </tr> <tr> <td></td> <td></td> <td>mat.</td> <td>14</td> </tr> </table>	{	male	16	imm.	2			mat.	14																																	
{	male	16	imm.	2																																												
			mat.	14																																												
3	13.00- 20.00	14	8	6	Atlantic population	<table style="display: inline-table; vertical-align: middle;"> <tr> <td rowspan="2" style="font-size: 2em; vertical-align: middle;">{</td> <td>female</td> <td>14</td> <td>imm.</td> <td>2</td> </tr> <tr> <td></td> <td></td> <td>mat.</td> <td>12</td> </tr> <tr> <td colspan="2"></td> <td></td> <td></td> <td></td> <td style="font-size: 2em; vertical-align: middle;">{</td> <td>preg.</td> <td>8</td> </tr> <tr> <td colspan="2"></td> <td></td> <td></td> <td></td> <td></td> <td>ovul.</td> <td>2**</td> </tr> <tr> <td colspan="2"></td> <td></td> <td></td> <td></td> <td></td> <td>rest.</td> <td>2</td> </tr> </table>	{	female	14	imm.	2			mat.	12						{	preg.	8							ovul.	2**							rest.	2									
{	female	14	imm.	2																																												
			mat.	12																																												
					{	preg.	8																																									
						ovul.	2**																																									
						rest.	2																																									

* Three out of these captured later (at 14, 16 and 18 o'clock).

** Having ovaries with functional corpora lutea but lacking fetus.

only one out of 24 examined for point no. 1 group (crosses), six out of 16 for no. 2 group (open circles), and six out of 14 for no. 3 (closed circles). These suggest that most whales of point no. 1 group belong to the West Indian population and whales of points nos. 2 and 3 to the Atlantic population. The later part in the range of time of capture for point no. 1 group overlaps with the early part in that of no. 2 group. These facts show that groups of whales belonging to different populations migrate to approximately same locality in the feeding grounds with slight time lags. This is a first example that can be regarded as the direct evidence for overlapping of migratory ranges of different populations. Further detailed evidences are shown in Figs. 3 and 4. Fig. 3 shows locations of capture of individual whales taken in Dec. 12, 1962 as grouped by catcher-boats. Ju2-positive type incidences were calculated as 27.8 per cent by testing 18 samples (5 Ju2-positives) for 26 whales taken by catcher-boats A, B, C, and D, and as 0.0 percent for 11 whales (all Ju1) by catchers E, F, G, and H. The former was regarded as those belonging to the Atlantic population (closed circles) and the latter to the West Indian population (open circles). Another chart basing on the log in Dec. 14, 1962

is drawn in Fig. 4 under the similar expression as previous one. There can be seen characteristic differences between these two figures as follows. Whales belonging to the Atlantic population were found and captured in the locations southern side of that for the West Indian population in the case of Fig. 3, but in Fig. 4 whales belonging to the Atlantic population were found at the both sides of locations for the West Indian population. While, the blood type incidence is maintained to be indigenous for each population, so that the observations described above can be

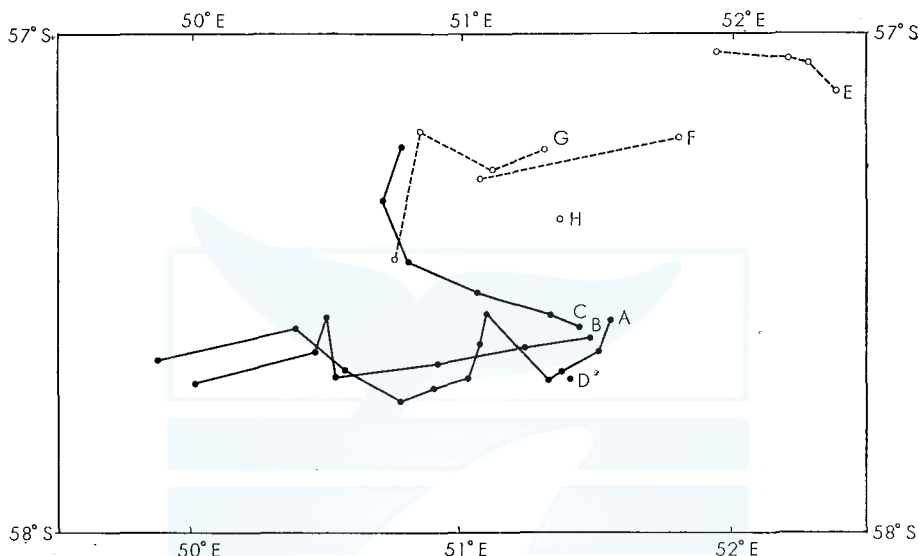

Fig. 3. Evidences showing mixing of the different populations in the feeding grounds as revealed by data of days when whales belonging to both the Atlantic and the West Indian populations were taken in a day. Population differences of whales grouped by catcher-boats, drawn by basing on the logs in Dec. 12, 1962, when 29 whales examined out of 37 those taken. Open and closed circles show the localities where individual whales belonging to the Atlantic and the West Indian populations respectively were taken. These were successively captured from 1st catch with alphabet letter showing different catcher-boats after chasing: All of 11 whales taken by catcher-boats E, F, G & H were typed as Ju 1. 13 and 5 taken by catcher-boats A, B, C & D were typed as Ju 1 and Ju 2-positives respectively.

interpreted as the most reliable evidences showing that despite of such interminglings in feeding grounds the different populations have been completely isolated each other in breeding from generation to generation.

Boundary of migratory ranges and rate of intermingling Table 8 shows frequency distribution of number of whales daily examined and of Ju2-positive whales occurred in those. In this table, scattered diagrams are divided into four zones by the three boundary lines corresponding to Ju2-positive incidences of 50, 33 and 20 percent respectively, and majority in zones more than 20 percent were identified as those representing whales which belong to the Atlantic or the Lower latitudinal populations. As stated already the former and the latter can be geographically distinguished each other. In Figure 1, are plotted noon positions of factory ships in some

intermittent days when the whales belonging to the Atlantic, the Lower latitudinal and the East Indian populations were taken during the three seasons. Small closed circles show those for the Atlantic population. According to this figure, this group of whales were taken on a band of ground which runs southeast direction from the whaling ground lying south of South Africa and extends to about 60° east, but did not occur in the catch from the northeastern side of this band in spite of fairly larger number of whales taken. This might suggest that the above-noted band might be interpreted as the east boundary of migratory range in feeding ground for the Atlantic population. According to the results obtained in the three seasons,

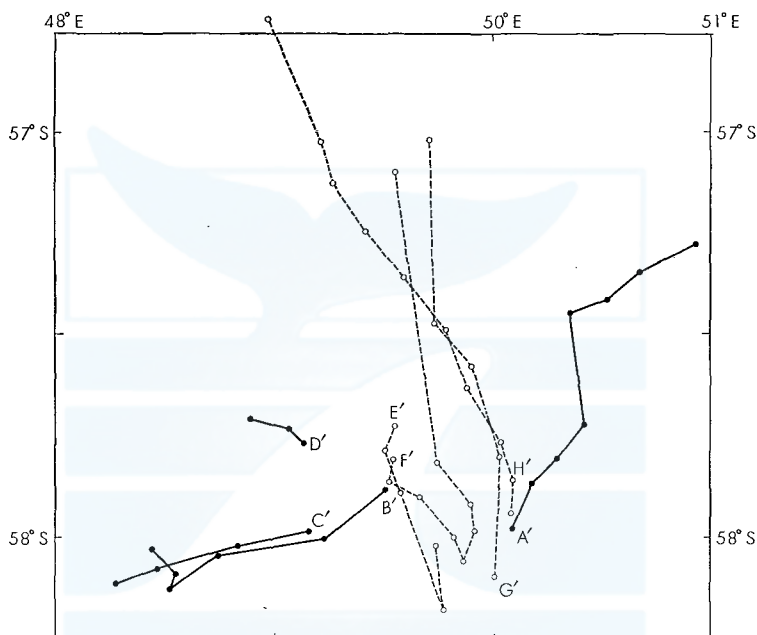

Fig. 4. Evidences showing mixing of the different populations in the feeding grounds as revealed by data of days when whales belonging to both the Atlantic and the West Indian populations were taken in a day. Population differences of whales also grouped by catcher-boats, drawn by basing on the logs of Dec. 14, 1962, when 45 whales were examined out of 50 those taken. 29 whales taken by E', F', G' & H' were typed as Ju1, so that, were regarded as those belonging to the West Indian population. 10 and 6 taken by A', B', C' & D' were typed as Ju1 and Ju2-positives and were recognized as those belonging to the Atlantic population.

in the east half of area III corresponding to the east end of the migratory range for this population distribute tolerable number of the Atlantic population in December at the beginning of whaling season, but hardly occur after January. Some exceptional records taking this group of whales in this ground, however, were made for each one day in mid- and late-March respectively in 1961/62 season. Ju2-positive type incidences in the east half of area II reveal fairly lower figures than those of pure Atlantic population, so that it can be thought that the West Indian population

TABLE 8. FREQUENCY DISTRIBUTION OF DAILY OCCURRENCE OF JU2-POSITIVE BLOOD TYPES

No. of whales daily examined	No. of Ju2-positives														Sum	
	0	1	2	3	4	5	6	7	8	9	10	11	12	13		14
1	79	4														83
2	95	4														99
3	71	5		1												77
4	65	9														74
5	59	6	2													67
6	52	6	2	1												61
7	48	5	1	3												57
8	26	4	2	1												33
9	32	1	2	1	2											38
10	26	4	3	1												34
11	20	2	1													23
12	13	4	1										100%			18
13	8	3	2													13
14	2	3		1												6
15	5	1														6
16	8	2	2													12
17	11	2														13
18	1	1	1	1	1	1	1									7
19		1														1
20	3	1		1						1						6
21	2	1	1													4
22	4	1	1													6
23	1		1													2
24	2	1	1		1											5
25	1												50%			1
26	1	2														3
27	1															1
28			1		1		1									3
29						1										1
30																0
31	1		1													2
32			1				1				1					3
33	1					1										2
34		1			1											2
35	2	2							1							5
36				1	1											2
37	1															1
38			1													1
39													33%			0
40		1												1		2
41																0
42				1										1		2
43																0
44	1															1
45							1									1
46																0
47																0
48			1													1
49										20%						0
53														1		1
Sum	642	77	28	13	7	3	4	0	1	1	1	0	0	1	2	780

disperses to this ground beyond the boundary between areas II and III. To make clear the west boundary of migratory range of the West Indian population should be extended the investigation hereafter to the western portion of area II. A part of the West Indian population disperses eastwards to the west portion of area IV and mingles with the East Indian population there. On the other hand, little numbers of East Indian population seem to distribute to area III, but inter-relation in boundaries of migratory ranges between West Indian population and East Indian population have not been made so clear as that between Atlantic population and West Indian population. As shown in Fig. 1 by small triangles, noon positions of factory ships in some intermittent days, when the whales of Lower latitudinal population were taken, mostly occur in the portion, of north of 50° south of area III, ranging from 30° east to 50° east.

Rates of intermingling of different populations can be estimated from blood type incidences for each pure population in Table 5 and those in various geographical grounds in Table 4. In area II (east half) and the higher latitudinal portion of area III (south of 50° south), 16 and 12 per cent of the samples respectively consist of the whales of Atlantic population and the residues are of West Indian population. As fairly large number of samples were tested for area III, the latter might be accepted to nearly represent actual figure of the population there for the periods of investigation. Rate of mingling of the Lower latitudinal population in the northern portion of 50° south of area III does not reach up more than 4.3 percent. As precise estimation of blood type incidences for the East Indian population has not been made, rate of mingling in the areas concerned should be postponed in future.

INTERMINGLING OF DIFFERENT POPULATIONS AS REVEALED BY RATE OF EMIGRATION OF WHALES MARKED

To obtain informations on migrations and on movements of whales, materials of marking investigations have been dealt in various ways (Brown, 1954 a, 1954 b, 1962 a, & 1962 b). For the purpose of identifying stocks, it might be more effective to analyse materials as geographical groups than to treat those as signs of movement of individual whales. Accordingly, in this paragraph will be mostly discussed the inter-areal relationships especially the problems of intermingling between areas II and III where different populations distribute respectively as clarified by blood typing investigations already. Calculations of rate of emigration between different areas will be made by basing on a method which was applied by the present author to the north Pacific fin whale stocks previously (Fujino, 1960).

Materials used Number of fin whales taken and number of fin whales marked and successively recaptured in the Antarctic during from 1932/33 to 1961/62 seasons were used to calculation. Table 12 shows the former figures which were cited from the International Whaling Statistics, and Tables 9, 10 and 11 show the latter figures which were arranged by compiling materials described in a series of Brown's reports (1954, '56, '57, '58, '59, '61 b & c). Number of whales taken and those recaptured at land stations in South Africa are not included in the figures of these tables. Fig.

5 shows the summarized results of marking investigations which were made in areas II, III and IV during the pre-war and the post-war seasons.

Methods and practice of calculations 1) Major points of calculations of rates of emigration between different areas follow those which were described in the previous paper (Fujino, 1960). For this purpose population sizes of the two different populations I and II of which the main stocks distribute in the grounds A and B neighbouring each other were expressed as N_1 and N_2 , and their relative abundances in the grounds A and B as a and $1-a$ for the population I and as $1-b$ and b for the population II respectively as shown in Fig. 6 diagrammatically. To make estimation of figures a and b averaging for the periods of investigations is the purpose of the present calculations.

2) In the light of length of lapse of years from marking to recapture and

TABLE 9. NUMBER OF FIN WHALES EFFECTIVELY MARKED IN AREA II AND SUCCESSIVELY RECAPTURED, 1932/33 TO 1961/62.

In the seasons of:
Recaptured in the area II,

No. of whales effectively marked	Marked in the season:	1932/3	'35/6	'40/1	'45/6	'50/1	'55/6	'60/1	Sum																							
		↓	↓	↓	↓	↓	↓	↓																								
Pre-war marks	200	1932/3	3	2	1	1	1	1	7																							
	—	'33/4	—	—	—	—	—	—	—																							
	299	'34/5	8	2	3	6	1	1	34																							
	572	'35/6	1	4	2	2	1	2	15																							
	652	'36/7	4	18	8	1	3	1	1	56																						
	447	'37/8	13	5 ^{a)}	4	4 ^{b)}	1	1	2	51																						
34	'38/9	—	—	—	—	—	—	—	2																							
Post-war marks	—	1945/6~52/3	—	—	—	—	—	—	—																							
	114	'53/4	—	—	—	—	4	2	5	15																						
	41	'54/5	—	—	—	—	1	1	—	3																						
	84	'55/6	—	—	—	—	1	10	1	14																						
	23	'56/7	—	—	—	—	2 ^{c)}	—	—	2																						
	4	'57/8	—	—	—	—	—	b)	b)	1																						
	—	'58/9	—	—	—	—	—	—	—	1																						
	—	'59/60	—	—	—	—	—	—	—	—																						
	ND*	'60/1	—	—	—	—	—	—	—	—																						
	ND*	'61/2	—	—	—	—	—	—	—	—																						
Sum		3	2	8	3	8	41	16	7	8	1	2	—	3	7	2	6	5	4	6	—	4	10	4	9	14	6	6	6	2	7	200

Recaptured in the area III,

Pre-war marks	1932/3	—	—	1	—	—	—	—	—	1																						
	'33/4	—	—	—	—	—	—	—	—	—																						
	'34/5	—	—	1	—	—	—	—	—	1																						
	'35/6	—	—	—	—	—	—	—	—	—																						
	'36/7	—	—	1	—	—	—	—	—	2																						
	'37/8	—	—	—	—	—	—	—	—	—																						
'38/9	—	—	—	—	—	—	—	—	2																							
Post-war marks	1945/6~52/3	—	—	—	—	—	—	—	—	—																						
	'53/4	—	—	—	—	—	—	—	—	1																						
	'54/5	—	—	—	—	—	—	—	—	—																						
	'55/6	—	—	—	—	—	—	—	—	1																						
	'56/7	—	—	—	—	—	—	—	—	2																						
	'57/8	—	—	—	—	—	—	—	—	—																						
	'58/9	—	—	—	—	—	—	—	—	—																						
'59/60	—	—	—	—	—	—	—	—	—																							
'60/1	—	—	—	—	—	—	—	—	—																							
'61/2	—	—	—	—	—	—	—	—	—																							
Sum		—	—	2	1	—	—	—	—	2	1	—	—	—	—	—	—	—	—	—	—	—	—	—	—	—	—	—	—	—	—	10

Remarks, * ND: No available data. In addition, one, two and three whales moved from area I were recaptured in c) d) f) g) h) j) l), in b) e) i) and in a) respectively. Also excluding one and two whales moved from lower latitudes and recaptured from j) and k) respectively. One, three and two whales which were marked in 1935/36, 1936/37 and 1937/38 respectively with no information on area recaptured are excluded. Each one whale marked in area II in 1934/35, 1936/37, 1937/38 and 1938/39 was recaptured in area I, and three marked in area II in 1953/4 also recaptured in area I.

TABLE 10. NUMBER OF FIN WHALES EFFECTIVELY MARKED IN AREA III AND SUCCESSIVELY RECAPTURED, 1932/33 TO 1961/62

In the seasons of:

Recaptured in the area II,

No. of whales effectively marked		Marked in the season :	1934/5	'40/1	'45/6	'50/1	'55/6	'60/1	Sum		
Pre-war marks	463	1934/5	—	2	—	—	—	1	5		
	285	'35/6	—	1	—	—	—	—	3		
	395	'36/7	—	—	—	—	—	—	—		
	11	'37/8	—	—	—	—	—	—	—		
	15	'38/9	—	—	—	—	—	—	—		
Post-war marks	4	1945/6~52/3	—	—	—	—	—	—	—		
	7	'53/4	—	—	—	—	—	—	—		
	194	'54/5	—	—	—	—	—	—	—		
	102	'55/6	—	—	—	—	3 2	3 1	9		
	2	'56/7	—	—	—	—	1 1	—	4		
	50	'57/8	—	—	—	—	—	—	—		
	35	'58/9	—	—	—	—	—	—	—		
	3	'59/60	—	—	—	—	—	—	—		
	ND*	'60/1	—	—	—	—	—	—	—		
	ND*	'61/2	—	—	—	—	—	—	—		
Sum			1	2	1	1	1	4	3	4	22

Recaptured in the area III,

Pre-war marks	1934/5	12	2	—	1 1	—	—	—	2	1 3 1	—	2 2 1 3	1	—	1	—	2 1 2	38 ^{a)}											
	'35/6	1	1	3	2 3	—	—	—	1 1	—	1	3 3 2	2	—	2 1	1 1 1	29												
	'36/7	1	—	—	—	—	—	—	—	—	—	1 1 1	—	—	—	—	5												
	'37/8	—	—	—	—	—	—	—	—	—	—	—	—	—	—	—	—												
	'38/9	—	—	—	—	—	—	—	—	—	—	—	—	—	—	—	—												
Post-war marks	1945/6~52/3	—	—	—	—	—	—	—	—	—	—	—	—	—	—	—	—	—											
	'53/4	—	—	—	—	—	—	—	—	—	—	—	—	—	—	—	—	—											
	'54/5	—	—	—	—	—	—	—	—	—	—	—	—	—	—	—	—	—											
	'55/6	—	—	—	—	—	—	—	—	—	—	5 1 2	2 1 1	5 6	23 ^{b)}														
	'56/7	—	—	—	—	—	—	—	—	—	—	1	—	2 1 2	4 1	11													
	'57/8	—	—	—	—	—	—	—	—	—	—	—	—	—	—	—	—												
	'58/9	—	—	—	—	—	—	—	—	—	—	—	—	2	1 1	4 ^{c)}													
	'59/60	—	—	—	—	—	—	—	—	—	—	—	—	—	3	2 1	6												
	'60/1	—	—	—	—	—	—	—	—	—	—	—	—	—	—	8 11	19												
'61/2	—	—	—	—	—	—	—	—	—	—	—	—	—	—	9	9													
Sum		12	3	2	3	3	4	—	—	—	—	2	1	2	3	2	—	5	6	4	9	5	2	9	7	7	22	31	144

Recaptured in the area IV,

Pre-war marks	1934/5	—	2	—	—	—	—	—	—	—	—	—	—	—	1 1 5	—	9
	'35/6	—	—	—	—	—	—	—	—	—	—	—	—	—	—	—	1 2
	'36/7	—	—	—	—	—	—	—	—	—	—	—	—	—	—	—	—
	'37/8	—	—	—	—	—	—	—	—	—	—	—	—	—	—	—	—
	'38/9	—	—	—	—	—	—	—	—	—	—	—	—	—	—	—	—
Post-war marks	1945/6~52/3	—	—	—	—	—	—	—	—	—	—	—	—	—	—	—	—
	'53/4	—	—	—	—	—	—	—	—	—	—	—	—	—	—	—	—
	'54/5	—	—	—	—	—	—	—	—	—	—	—	—	—	—	—	—
	'55/6	—	—	—	—	—	—	—	—	—	—	—	—	—	—	—	—
	'56/7	—	—	—	—	—	—	—	—	—	—	—	—	—	—	—	—
	'57/8	—	—	—	—	—	—	—	—	—	—	—	—	—	—	—	—
	'58/9	—	—	—	—	—	—	—	—	—	—	—	—	—	—	—	—
	'59/60	—	—	—	—	—	—	—	—	—	—	—	—	—	—	—	—
'60/1	—	—	—	—	—	—	—	—	—	—	—	—	—	—	—	—	
'61/2	—	—	—	—	—	—	—	—	—	—	—	—	—	—	—	—	
Sum		—	2	—	—	—	—	—	—	—	—	—	—	—	—	—	—

Remarks, *ND: No available data. In addition, in lower latitude (land stations) were recaptured one in a) in 1937, two and one in b) in 1959 and 1962 respectively and two in c) in 1959. One whale moved from area I is excluded. One, two and two whales, which were marked in 1957/58, 1954/55 and 1961/62 respectively, with no information for area but recaptured, are also excluded.

complexity of the factors concerned, calculations were made with priority given to the pre-war marks and with a prospect obtaining complementary knowledges from the post-war marks.

3) Pre-war marks shot in area II in the five seasons of 1932/33, 1934/35, 1935/36, 1936/37 and 1937/38 and those in area III in the three seasons of 1934/35, 1935/36 and 1936/37 were used. Marks shot in area II in 1938/39 and those in area III in 1937/38 and 1938/39 were excluded from calculations because of few numbers of the whales effectively marked.

TABLE 11. NUMBER OF FIN WHALES EFFECTIVELY MARKED IN AREA IV AND SUCCESSIVELY RECAPTURED, 1932/33 TO 1961/62

In the seasons of:

Recaptured in the area III,

No. of whales effectively marked		Marked in the season:	1934/5	'40/1	'45/6	'50/1	'55/6	'60/1	Sum
Pre-war marks	19	1934/5	1						1
	48	'35/6							
	58	'36/7							
		'37/8			1				1
		'38/9							
Post-war marks	1	1953/4							
		'54/5							
	14	'55/6					1		1
	2	'56/7							
	8	'57/8							
	15	'58/9							
	59	'59/60						2	2
	ND*	'60/1							
ND*	'61/2								
Sum					1		1	2	4

Recaptured in the area IV,

Pre-war marks	1934/5			1					1	1		4
	'35/6		1	1						1		3
	'36/7											
	'37/8											
	'38/9											
Post-war marks	1953/4											
	'54/5											
	'55/6							1				1
	'56/7											
	'57/8						1					1
	'58/9							1				1
	'59/60							9	1	2		12
	'60/1								3			3
'61/2												
Sum			1	2		1		1	2	12	4	25

Remarks, *ND: No available data. In addition, were recaptured each one in a) and b) and three in c) which were marked in the area V. Three whales marked in 1959/60 but with no information on area recaptured are excluded. One whale marked in 1955/6 and moved to area V are also excluded.

4) Post-war marks shot in area II in the season of 1953/54, 1954/55 and 1955/56 and those in area III in the seasons of 1954/55 and 1955/56 were used.

5) As the numbers of whales effectively marked in area IV were small, calculations were not undertaken for these marks.

6) Number of whales taken and of those recaptured at land stations in South Georgia Islands were made together with those of the pelagic operations in area II for the calculation.

7) The following arrangements were made for various parameters necessary for calculations. a) As discussed in the previous paper (Fujino, 1960), errors in the estimates of rate of confirming (g) whales as 'Hit' among those effectively marked and of rate of recovery of marker (f) from whales actually recaptured do

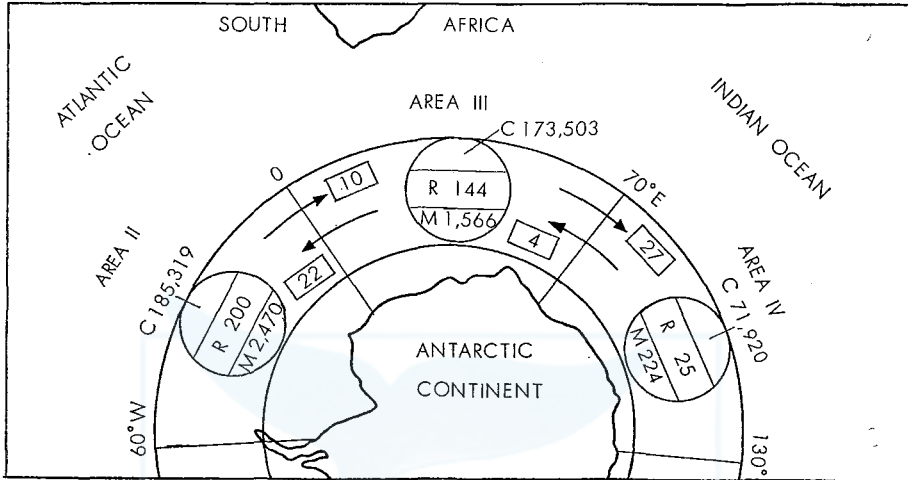

Fig. 5. Summarized results of emigration of marked fin whales between areas II, III and IV during from 1932/3 to 1961/2 seasons (compiled from reports by S. G. Brown). Figures in circles with alphabet letters C, R and M show summarized numbers of fin whales taken, of marked whales recaptured up to 1961/2 seasons and number of fin whales effectively marked respectively. Figures with arrow mean number of whales recaptured after moving to the different areas.

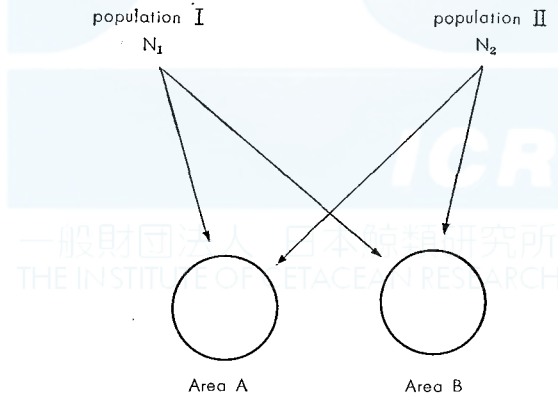

Fig. 6. Diagrammatic interrelationships between different two populations distributed in the neighbouring two areas as shown by movements of marked whales.

hardly effect upon final results of calculation for the rates of emigrations. Then no g - and f -corrections were made. Although materials have not been available, however, it could be assumed that there exist significant differences in the figures of f

between Japanese and the foreign fleets in relation to the methods of treating whale body especially whether or not utilize meats. Therefore the recoveries of pre-war marks in the seasons after 1960/61 when Japanese fleets commenced intensive operations in area III were not included. While, for calculation on the post-war marks, all recovery up to 1961/62 season was used because of avoiding reduction of number of data. b) Sufficient materials of age-composition, which can be used to estimate mortality rates for both pre-war and post-war seasons, are not available. It seems to be impossible, even if materials were available, to estimate precisely mortality rate for each year. Then figures 0.10 and 0.05 were arbitrarily used as annual rate of total mortality and annual rate of natural mortality respectively averaging for the whole periods of investigations involved. The latter figure was applied as annual mortality rate to five seasons from 1940/41 to 1944/45 for area III and to the

TABLE 12. NUMBER OF FIN WHALES TAKEN IN THE AREAS II, III AND IV DURING FROM 1933/34 TO 1961/62*

Area	1933/4	'34/5	'35/6	'36/7	'37/8	'38/9	'39/40	'40/1	'41/2	'42/3
S. Georgia	1,728	836	520	1,079	1,552	1,307	937	747	1,189	776
II	1,115	2,246	3,375	6,004	11,505	6,252	7,840	831	—	—
III	2,178	7,985	5,236	5,002	8,297	5,710	2,218	49	—	—
IV	2,177	1,368	548	2,285	6,610	5,540	574	—	—	—
Area	1943/4	'44/5	'45/6	'46/7	'47/8	'48/9	'49/50	'50/1	'51/2	'52/3
S. Georgia	632	987	1,456	1,670	2,142	1,922	1,999	1,982	2,007	1,670
II	529	679	4,901	4,655	6,136	4,995	7,150	5,081	5,977	4,551
III	—	—	2,800	4,382	6,483	6,457	5,117	4,133	7,122	11,364
IV	—	—	—	3,355	4,654	3,068	2,940	4,210	2,141	1,449
Area	1953/4	'54/5	'55/6	'56/7	'57/8	'58/9	'59/60	'60/1	'61/2	
S. Georgia	2,673	2,746	2,669	2,057	2,251	1,291	1,160	1,387	661	
II	7,653	4,963	6,619	10,697	5,211	4,298	4,920	5,223	6,650	
III	11,459	13,607	7,088	3,812	9,197	9,385	9,307	13,269	11,847	
IV	2,195	2,790	3,208	291	3,579	7,277	6,501	2,086	3,129	

* Cited from the International Whaling Statistics.

six seasons from 1940/41 to 1945/46 for area IV during the World War II. It was already discussed in the previous paper that these arrangements hardly influence upon the final results of calculations.

8) As lapse of years from marking to recapture for the Antarctic investigations is generally longer than that for the north Pacific, to obtain the mean value (\bar{r}) from rate of recapture for each year of marking was made simple arithmetical averaging instead of that with weight expressed by formula 6 in the previous paper (Fujino, 1960, p.111).

9) According to the results of stock assessments on the Antarctic fin whale population (Fifteenth Annual Meeting of International Whaling Commission, June, 1963), it is obvious that the stock of this species has not been in a stabilized state throughout pre-war and post-war seasons. For the convenience of calculation for the rate of emigration, however, number of survivors (C') of initial stocks at the time

of marking in the annual catches (C) in successive years were obtained by formula 12 in the previous paper (Fujino, 1960). It can be understood, even if such arrangements were made, from the definition of rate of emigration and formulae 5 and 6 in the previous paper that final results of calculation must be little biased from those to be obtained by considering annual stock size fluctuations which were demonstrated by the stock assessment.

Results of calculation and their interpretations Table 13 shows the results of calculations on the rates of emigration between areas II, III and IV. In this table figures are

TABLE 13. RATE OF EMIGRATION CALCULATED BY MARKING RETURNS FOR THE PRE-WAR AND THE POST-WAR MARKS^{a)}

Rate of emigration	Pre-war marks*		Post-war marks
	A	B	
$r_2^2/r_2^2+r_3^2$	0.88 (0.88) ^{b)}	0.90	0.83
$r_3^2/r_2^2+r_3^2$	0.12 (0.12)	0.10	0.17
$r_3^3/r_3^3+r_2^3$	0.93	0.90	0.58
$r_2^3/r_3^3+r_2^3$	0.07	0.10	0.42
$r_3^3/r_3^3+r_4^3$	0.88 (0.88) ^{b)}	0.78	0.68 (0.77) ^{c)}
$r_4^3/r_3^3+r_4^3$	0.12 (0.12)	0.22	0.32 (0.23)
$r_2^3/r_2^3+r_3^3+r_4^3$	0.11 (0.10) ^{b)}	0.08	0.32 (0.35) ^{c)}
$r_3^3/r_2^3+r_3^3+r_4^3$	0.69 (0.61)	0.71	0.47 (0.50)
$r_4^3/r_2^3+r_3^3+r_4^3$	0.20 (0.29)	0.21	0.21 (0.15)

Remarks, Calculation was made for the two cases including (A) and excluding (B) recaptures in post-war seasons, 1945/46 through 1959/60. a) No calculation was made for recapture of whales marked in area IV. b), c) Figures in parenthesis correspond to those excluding higher rate of recovery for area II in 1940/41 and for area IV in 1959/60 respectively.

shown for both pre-war and post-war marks. The former those are further subdivided into two cases of A and B whether or not including the post-war recoveries respectively. Figures in parenthesis correspond those for the case excluding materials for the year when high rate of recovery was recognized. At first the results for pre-war marks will be discussed.

As regards inter-relations between areas II and III, rate of emigration from areas II to III, $r_3^2/r_2^2+r_3^2$, reveals figures of 0.10 and 0.12 for two cases A and B respectively, and that from areas III to II, $r_2^3/r_3^3+r_2^3$, 0.07 and 0.10 respectively. These results confirm the non-random distribution of whales in areas II and III, saying in other words, existence of the different populations, and show that approximately 10 percent of the Atlantic population contribute to the stock in area III and also approximately same percent of the West Indian population distribute to area II. Definite informations for relative stock size between the Atlantic and the West Indian populations have not been available. If both populations have comparable sizes of stocks, however, figures of the rate of emigration from areas II to III noted above correspond to the rate of intermingling of the Atlantic popula-

tion in area III which is close to that obtained from the blood typing investigations. The results may lead to obtain following informations. Although in areas II and III distribute the different populations which migratory ranges overlap each other, the facts that both figures of rate of emigration reveal approximately 10 percent suggest that final surplus and deficit of the stock for each area are in consequence comparatively small. This might be important as a basic information to make stock assessment for each geographical area separately. Rate of emigration from areas III to IV, $r_4^3/r_4^3 + r_3^3$, ranges from 0.12 to 0.22 which are bigger than those between areas II and III. Reasons that marked inconsistency was seen between figures for two cases A and B have not been made obvious.

Rates of emigration calculated from post-war marks reveal bigger figures than those from pre-war marks. Although no sufficient evidence has been given, the following probable reasons could be assumed to be concerned. Then it might be impossible to expect nothing more reference informations from the post-war marks at present. 1) In post-war seasons when marking investigations have been undertaken, the major whaling grounds in area III moved to the lower latitudes, so that whales of the Lower latitudinal population contribute to the catches in this area besides the West Indian population. 2) The Japanese fleets utilizing whale meats commenced their intensive operation in areas III and IV. 3) Scantiness of whales effectively marked might bring larger errors and some biases.

OTHER BIOLOGICAL CHARACTERISTICS RELATED TO DIFFERENCE OF STOCKS

As discussed in the previous paragraphs, it became to be obvious that in areas II, III and IV distribute at least four different fin whale populations. Some biological characteristics related to the difference of population will be described and discussed in this paragraph.

Differential Sizes of Group of Whales by Stock

As the numbers of samples daily collected by Kyokuyo-maru No. 2 in 1960/61 season and by Kyokuyo-maru Nos. 2 and 3 in 1962/63 season were generally large, majority of whales taken in these days can be identified as those of Atlantic population and of West Indian populations by basing on blood type incidences and localities of capture. In Table 14 are shown frequency distributions of 'number of whales observed' for groups from which whales were taken according to four different classes of blood type incidences. In this table groups of whales, which Ju2-positive incidences show zero percent, were regarded as those of pure West Indian population, and those more than 11 percent as groups in which whales of Atlantic population mingle at fairly high percentages. Comparing these distributions between the two different stocks, in the former the classes less than 10 whales and more than 41 whales occupy 37 and 21 percent respectively on an average 29 whales, and in the latter those less than 10 whales only 5 percent and contrarily those more than 41

whales 44 percent on an average 48 whales. This result of observations suggests that size of group of whales migrating to the feeding grounds in the Antarctic is different by stocks each other. Although no available data has been obtained to

TABLE 14. FREQUENCY DISTRIBUTION OF NUMBER OF WHALES OBSERVED, SUGGESTING POSSIBLE DIFFERENTIAL SIZES OF SHOALS BY RACES IN THE FEEDING GROUNDS*

No. of whales observed	Percentage incidence of Ju2-positive types		
	0	1 to 10	more than 11
1- 5	4	0	1
6-10	10	0	2
11-20	8	2	14
21-40	8	7	14
41-80	4	1	11
more than 81	4	2	14
Sum	38	12	56
Average no. of whales	29	42	48

* Basing on the logs of catcher-boats.

discuss what other biological characteristics of the population correlates with this fact, this may bring some problems to the hypothetical basis on 'the geographical uniformity of distributing concentration of animals' in stock assessments.

Natural Selection Related to Blood Types

Many discussions on natural selections related to blood types have been published in recent years from the view-points of Human Genetics and Anthropology. Although some informations concerning to relationships between blood types and fertility or age were noted already by the present author (1963b), additional evidences are described in this section.

Differential rates of pregnancy by blood types According to the results of the following observations, Fujino (1963a) describes for the first time that the fairly strong intra-uterine selection of Ju1·2 heterozygous fetuses might occur in whales in relation to the maternal-fetal incompatibility of blood types and states that incidences of the

TABLE 15. DIFFERENTIAL PERCENTAGE PREGNANCY BY BLOOD TYPES IN THE ATLANTIC FIN WHALE POPULATION

Blood types	1960/61	1961/62	Sum
Ju1 (P_1)	63.9 (36)	55.6 (18)	61.1 (54)
Ju2-positives (P_2)	78.9 (19)	75.0 (8)	77.8 (27)
P_1/P_2	0.81	0.74	0.78

Remark, Figures in parenthesis mean the number of mature females examined.

selection will closely relate to the frequency of occurrence of blood types of the population. The observations include that 1) rate of finding fetuses from mature females is lower in Ju1 type mothers than in Ju2-positive types those; the differences are statistically significant and that 2) isoantibodies from Ju1 female donors reveal

hemolytic property and significant high titres were detected for the isoserums of Ju1 female donors from which fetus was not found in spite of having functional corpus luteum in their ovaries and congested uteruses. As shown in Table 15, observations in 1961/62 season confirm the results of differential apparent rate of pregnancy noted above.

Blood type and age Table 16 shows relative blood type incidences in connection with age classes which are expressed by number of laminae layers of ear-plug. It can be seen from this table that incidences of Ju2-positive types decline and contrarily those of Ju1 type ascend in accordance with increment of ages and that these trends are statistically significant. This observation suggests that relative viability between different blood types varies in relation to age classes. As reproducibility lasts to fairly older age classes in this species of whales, these facts can be assumed to play an important role in maintaining blood type gene frequencies in a population together with the differential rate of pregnancy noted already.

Relation between Intra-uterine Selection and Ovulating Cycle

Basing on knowledges in human genetics, Fujino (1963 b) noted that stages of the intra-uterine selection could be broadly divided into pre- and post-fertilization

TABLE 16. RELATIONSHIPS BETWEEN AGE AND BLOOD TYPES IN THE ATLANTIC POPULATION*

No. of laminae of ear-plug	Blood types**		Sum
	Ju1	Ju2-positives	
11-20	19 (55.9)	15 (44.1)	34
21-30	13 (72.2)	5 (27.8)	18
31-40	14 (82.4)	3 (17.6)	17
more than 41	14 (77.8)	4 (22.2)	18
Sum	60 (69.0)	27 (31.0)	87

Remark, * Sum of males and females, 1960/61 and 1961/62 seasons. Figures in parenthesis show relative incidences in percent.

** $X^2=4.98$, 7 d.f., $0.70 > P > 0.50$.

those which probably more intensive selective pressure plays in the former. If the differential rate of pregnancy shown in Table 15 is actually caused by in part descending of rate of fertilization in Ju1 type mother whales, it should lead to accelerate successive ovulations in the infertilized individuals. The frequencies of ovulation in a breeding period may be different by blood types of mother whales and also different on the average by races which have different incidences of blood types each other. In consequence it must reflect on geographical differences in accumulating rate of ovarian corpora as noted previously. Table 17 shows the comparison of accumulating rates of ovarian corpora per two laminae layers of ear-plug drawn by ovulation-lamination keys (Form D) which were submitted to the Joint Meeting of the Special Committee of Three and the Ad Hoc Scientific Committee of the International Whaling Commission held in Seattle, December, 1962.

Figures for area II in this table were cited from those of Laws (1961). Marked geographical differences are seen in these figures by area. Materials, by which these figures were drawn, base on the observations for ovaries and ear-plugs made by the several biologists of the Whales Research Institute. Even if some individual errors are involved in readings, it can be said that the geographical differences are significant. Among the materials for area III of Table 17, readings for number of ovarian corpora were made by author himself who served as a biologist on board in 1960/61 season and those for ear-plug laminae by several staffs of the Institute. The results show fairly marked differences between west-half and east-half of area III. It was noted already (Fujino, 1963 b) that types of frequency distribution of accumulated number of ovarian corpora at an age class expressed by ear-plug laminae are not always symmetrical, but are rather different by area. Geographical differences in accumulating rate and type of frequency distributions of ovarian corpora between west- and east-halves of area III seem to support the concept proposed already. Fig. 7 shows the analysis of frequency distribution for west-half of area III, which was presented in Fig. 2 in the previous paper (Fujino, 1963 b), by normal probability paper. This figure shows that the bimodal distribution for this area can be divided into two components which correspond 0.6 (83 percent) and 1.4 (17 percent) of average rates of accumulating corpora per two laminae of ear-plug respectively. According to Fujino (1963 a), possible relationships of rates

TABLE 17. ACCUMULATION RATE OF OVARIAN CORPORA OF THE FIN WHALES TAKEN FROM DIFFERENT AREAS OF THE ANTARCTIC*

Areas					
II	W. III**	E. III**	IV	V	VI and I
2.80~3.00	2.31	1.91	1.84	1.80	1.60

* Cited from Fujino (1963b).

** Temporarily divided into the two portions of west-half and east-half at 35 degrees east longitude.

of pregnancy between three blood types for the Atlantic population can be expressed as $Ju1 \leq Ju2 \leq Ju1 \cdot 2$. Basing on the above-noted concept, relative rates of accumulating corpora will be arranged in a reverse order. Therefore it can be thought that one components showing higher accumulating rate (1.4) corresponds to $Ju1$ group of the Atlantic population and another component of lower rate (0.6) consists of $Ju1 \cdot 2$ group of the Atlantic population and also of all kinds of Ju blood groups of the West Indian population. Although distribution corresponding to $Ju2$ homozygote group of the Atlantic population does not appear clearly as a component in Fig. 7 probably because of its low incidence (less than 2 percent), it might constitutes a component which may have an intermediate mean between above-noted two figures. According to Fujino (1963a), intra-uterine selection related to Ju blood type incompatibility little occurs in the West Indian population because of the low incidences of $Ju2$ -positive types, so that it can be assumed that type of distribution is nearly a symmetrical one at least regarding to Ju blood type system. By these concepts, relative incidences of the two components of the distribution in Fig. 7 well consistent with those calculated from rate of intermingling of both po-

pulations for this geographical area (Fujino, 1962). Thus the quantitative relationships will become to be obvious for a pure population between three factors of the relative incidences of blood types, the incidences of intra-uterine selection due to blood type incompatibility, and the rate of accumulating ovarian corpora in females. These observations and analyses could offer some reliable informations

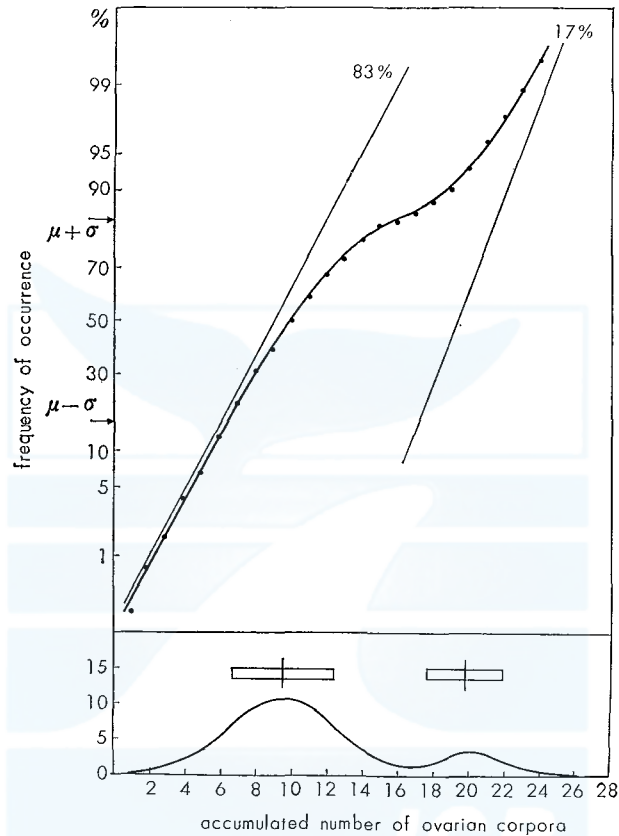

Fig. 7. Analysis of the bimodal frequency distribution of the accumulated number of ovarian corpora at an age class of 28 laminae of ear-plug for the west-half of area III by normal probability paper, showing that this consists of more than one component distributions (see text).

to an essential problems in ovulating cycles especially to the details in frequency of ovulation, if simultaneous examinations could be precisely made in blood typing, in counting accumulated number of ovarian corpora and in reading number of ear-plug laminae for each individual females belonging to a pure population such as the Atlantic one.

SUMMARY

This paper deals with problems of identification of breeding populations, migratory

range of each population and some other biological discussions on the fin whales taken from the Antarctic whaling areas II, III and IV by means of the blood typing and the marking investigations. These base upon the materials of approximately six thousands blood specimens collected by Japanese expeditions during three successive seasons from 1960/61 to 1962/63 and those of recoveries of the pre-war and the post-war marks compiled from data described in a series of Brown's publications. It was emphasized throughout this paper that the facts of overlap of migratory ranges of different populations made situations of problems in population study much more complex. The observations and the discussions in the present paper will be summarized as follows.

1. By the agglutination reactions with immune rabbits' and fowls' serums, erythrocytes of the Antarctic fin whales were classified into Ju major three groups, i.e., Ju1 homozygote, Ju1·2 heterozygote and Ju2 homozygote, in which the latter two were further divided into five subtypic specificities, amounting to eleven kinds in all.

2. Results of X^2 tests for the relative incidences of the major three blood groups for the pure population might support that the hypothetical major two equal allelic system is involved as noted in the previous paper (Fujino, 1962).

3. Non-random geographical distributions of Ju blood type incidences show that four different breeding populations distribute in the Antarctic whaling areas II, III and IV which can be named as the Atlantic, the West Indian, the East Indian, and the Lower latitudinal populations. Most of these results might support the Brown's findings (1962 b), but no specific description has been made for the Lower latitudinal population. Ju2-positive types incidences were estimated as 30.7, 2.4, 4.0 and 32.8 percent for each pure population noted above. As regards the latter two figures, more precise estimates will be expected after conducting further investigations. The Atlantic and the Lower latitudinal populations can be distinguished by the differential Ju2 subtypic incidences.

4. Direct evidences showing overlaps of the migratory ranges of the different populations in feeding grounds were described by basing on the logs of days when whales belonging to both the Atlantic and the West Indian populations were taken in the same day.

5. Boundaries of migratory ranges for some populations in the feeding grounds were estimated. Whales of the Atlantic population disperse eastwards to area III, and the east side boundary of migratory range of this population was became to be obvious. On the other hand whales of the West Indian population migrate westwards to the east-half of area II, but its west side boundary has not been made clear. Then migratory ranges of these two population overlap in the feeding grounds each other. Major migratory range of the Lower latitudinal population was estimated from locations of capture to cover a part of area III ranging from 30° east to 50° east, north of 51° south.

6. Rate of intermingling of the Atlantic population in the whales taken from area III was calculated to be 14 percent or less by blood typing data. According to the rates of emigration calculated from marking returns, approximate 10 percent

of the Atlantic population disperse to area III, and about 10 percent of the West Indian population disperse to area II. If the both sizes of the two populations are comparable each other, these figures show the rate of intermingle for each area as they are.

7. Significant difference was seen in the frequency distribution of number of whales observed from catcher-boats between the Atlantic and the West Indian populations in feeding grounds. Although it has not been made obvious what factors correlate with this result of observation, it may bring some problems to the hypothetical basis for the 'geographical uniformity in distributing concentration of animals' in stock assessment.

8. Additional data were obtained to confirm the occurrence of intra-uterine selection due to maternal-fetal incompatibility of Ju blood types for the Atlantic fin whale population which was reported already (Fujino, 1963 a).

9. Relative incidences of Ju blood types were compared by different age classes for the samples taken from the Atlantic population. Slight but significant difference was seen between different blood groups in the relative viability in accordance with increment of ages. This fact was interpreted to play an important role in maintaining the blood type gene frequencies in a population together with the fact noted as item 8 in this summary.

10. Possible influences of the intra-uterine selection to the ovulating cycles were discussed, and the mechanisms that might bring geographical differences in the rate of accumulating ovarian corpora were considered as a preliminary meaning.

REFERENCES

- BROWN, S.G. (1954a). Dispersal in blue and fin whales. *Discovery Rept.*, 26: 355-84.
- BROWN, S.G. (1954b). The movements of fin and blue whales in Antarctic Waters. *Norsk Hvalfangst-Tid.*, 43 (6): 301-9.
- BROWN, S.G. (1956). Whale marks recently recovered. *Norsk Hvalfangst-Tid.*, 45(12): 661-4.
- BROWN, S.G. (1957). Whale marks recovered during the Antarctic Whaling Seasons 1956/57. *Norsk Hvalfangst-Tid.*, 46(10): 535-9.
- BROWN, S.G. (1958). Whale marks recovered during the Antarctic Whaling Season 1957/58. *Norsk Hvalfangst-Tid.*, 47(10): 507-7.
- BROWN, S.G. (1959). Whales marks recovered in the Antarctic Seasons 1955/56, 1958/59, and in South Africa 1958 and 1959. *Norsk Hvalfangst-Tid.*, 48(12): 609-16.
- BROWN, S.G. (1961). Whale marks recovered in the Antarctic Whaling Season 1960/61. *Norsk Hvalfangst-Tid.*, 50(10): 407-10.
- BROWN, S.G. (1962a). A note on migration in Fin Whales. *Norsk Hvalfangst-Tid.*, 31(1): 13-6.
- BROWN, S.G. (1962b). The movements of Fin and Blue Whales within the Antarctic Zone. *Discovery Rept.* 33: 1-54.
- BROWN, S.G. (1962c). Whale marks recovered during Antarctic Seasons 1960/61, 1961/62, and in South Africa 1962. *Norsk Hvalfangst-Tid.*, 51(11): 429-34.
- CLARK, R. & BROWN, S.G. (1957). International co-operation in Antarctic whale marking from 1945 to 1957. *Norsk Hvalfangst-Tid.*, 46(9): 513-17.
- CUSHING, J.E., K. FUJINO & K. TAKAHASHI (1959). Glycerol-freezing technique as an aid in blood-typing of whales. *Sci. Rept. Whales Res. Inst.*, 14: 89-100.
- FUJINO, K. (1960). Immunogenetic and marking approaches to identifying sub-populations of the north

- Pacific whales. *Sci. Rept. Whales Res. Inst.*, 15 : 85-142.
- FUJINO, K. (1962). Blood types of some species of the Antarctic whales. *American Naturalist*. 96 (889) : 205-210.
- FUJINO, K. (1963a). Intra-uterine selection due to maternal-fetal incompatibility of blood types in the whales. *Sci. Rept. Whales Res. Inst.*, 17 : 53-65.
- FUJINO, K. (1963b). Population genetics of whales with reference to blood types. *Bul. Jap. Soc. Sci. Fisheries*, 29(12) : 1133-38.
- LAW, R.M. (1961). Reproduction, growth and age of Southern Fin Whales. *Discovery Rept.*, 31 : 327-486.
- Office of the International Whaling Commission (1963). International Whaling Commission, Fifteenth Annual Meeting. *Norsk Hvalfangst-Tid.*, 52(8) : 225-26.



一般財団法人 日本鯨類研究所
THE INSTITUTE OF CETACEAN RESEARCH

PRENATAL DEVELOPMENT OF EAR PLUG IN BALEEN WHALES

TADAYOSHI ICHIHARA

The ear plug is a fairly soft tissue existing in the external auditory meatus of the Mysticeti. It is composed of independent two tissues derived from the epidermis of external auditory meatus and from that of so-called glove-finger. The glove-finger projects outwards from the tympanic bulla into the external auditory meatus. Since Purves (1955) found out ring-like laminae in the longitudinally bisected plug-core derived from the epidermis of the glove-finger, the plug-core has enchanted many cetacean biologists interested in determining the age of whales. Counting the ring-like laminae to evaluate age of baleen whales is no more than understanding life histories of these whales through their ear plugs.

As series of studies on ear plugs, I have much interested in the formation of ear plugs in the prenatal stage, because animal tissues begin to develop from the prenatal period and the epidermis of the glove-finger also belongs to the same growth category. It was also necessary to confirm my previous finding (Ichihara, 1959) through the many materials from the baleen whale fetuses. In this paper, I examine the morphology and histology for the prenatal development of the glove-finger along with the ear plug. The keratinized and fatty degeneration of epidermal cells of the glove-finger are alternately accumulated to form the plug-core in the postnatal stage of the baleen whale. The present study not only supports this fundamental mechanism found by me, but also gives some suggestions to interpret the factors affecting the formation of the plug-core.

I am much indebted to Dr. Hideo Omura, the Director of our Institute for his kind support throughout this work. My sincere thanks are due to Messrs. Toshitomo Shida and Yasuji Fukuda, the Department of Anatomy, Faculty of Medicine, University of Tokyo, for their kind helps in the histological examination and photomicrographic technique. I also indebted to Dr. Kazuo Fujino, a staff of our Institute, who collected several heads from fin whale fetuses in the Antarctic expedition and brought them to my study.

MATERIAL AND METHOD

Most of materials in this paper were collected by myself on board Nisshin-maru, a factoryship of Taiyo Gyogyo Company in the Antarctic expedition in the 1959/60 season. Fetuses were taken from the uteri of flensed mother whales. After measuring the lengths of fetuses, their heads were cut off and pieces available for this study, that is, posterior portions of heads including the external auditory meatus, glove-finger and tympanic bulla were obtained. These specimens were preserved in the 10% formalin solution soon after this treatment. The large blocks from full-grown fetuses are preserved in diluted formalin solution under 10% as the first step and

removed gradually into concentrated solution for the examination at our Institute. In the same way Dr. Fujino kindly presented me several heads from fin whale foetuses in the Kyokuyo-maru No. 2 expedition in the 1960/61 Antarctic season. These specimens are used to check my interpretation. The examined specimens which I collected comprise 48 Antarctic fin whale (*Balaenoptera physalus*), 17 sei whale (*Balaenoptera borealis*) and 2 humpback whale (*Megaptera novaeangliae*) foetuses as presented in the appendix.

Law's finding (1959) for the foetal growth curve is applied to determining accurate foetal months from the lengths of examined foetuses. According to Laws the average duration of gestation is 11 1/4 months for the Antarctic fin whale and about 12 months for the North Pacific sei whale.

I counted numbers of ovulation in mother's ovaries at the spot aboard the factory ship to evaluate the relative age of the mother whale. The examined foetuses are obtained from mother whales of various ages and there is no bias in the sampling, in which I intended to obtain the foetuses of various length. The specimens from foetuses under 71 cm, corresponding to the 3 3/4 foetal months, also were obtained but failed to be examined in the sectioning course. These blocks from heads were dissected for the morphological study. Later glove-fingers and ear plugs were embedded in the celloidin solution, and sectioned in the thickness from 10 to 15 μ . The staining method by haematoxylin eosin was applied.

The post-mortem times range from 1 hour and 25 minutes to 13 hours and 35 minutes for the foetuses of fin whales, from 45 minutes to 9 hours and 40 minutes for the sei whale foetuses, and from 3 hours and 45 minutes to 7 hours and 5 minutes for the humpback whale foetuses, as listed in the appendix. In addition to the specimens from such foetuses, I examined the prenatal layers of ear plugs from adult baleen whales, which also includes the blue (*Balaenoptera musculus*), the Bryde's (*Balaenoptera edeni*) and the minke whale (*Balaenoptera acutorostrata*).

MORPHOLOGY OF GLOVE-FINGER AND EAR PLUG

In the course of dissecting the external auditory meatus of foetuses from the ear hole to the tympanic bulla through the blubber, I observed the colour on the surface of auditory meatus and glove-finger and then measured the length of space from the blind section beneath the blubber to the distal end of the glove-finger. Taking the glove-finger out of the auditory meatus, I measured the length of glove-finger, from its distal end to the proximal end of tympanic ligament, and its breadth.

From the colour on the surface of glove-finger and from that on the internal wall of external auditory meatus, four stages are present in the foetal stage of the baleen whale as indicated in Table 1. In fin whales, stage I indicates the development until the 3rd and 4th foetal months, stage II the 5th and 6th foetal months, stage III from the 7th to 9th months and stage IV after the 10th foetal months. In sei whales, stage II represents the 5th to 7th foetal months. Glove-fingers of foetuses in stage I are transparent and rather whiter. From stage II to III their colours change from pinkish-white to dark-brown. In stage IV, glove-fingers of

fin whales are brown, while those of sei whales do gradually black. Ear plugs from adult sei whales is more black than that from fin whales. The content of melanin during the keratinized degeneration of epidermal cells probably is more abundant for the sei whale than for the fin whale. The colours of stage IV are maintained from juvenile to adult both for fin whales and for sei whales. The observation for foetuses of the humpback whale is insufficient for describing the colour change during foetal development but glove-fingers are pinkish-white in stage II.

TABLE 1. COLOUR OF GLOVE-FINGER, EXTERNAL AUDITORY MEATUS AND BLIND SECTION FOR EACH FOETAL MONTH OF THREE SPECIES IN THE BALEEN WHALE

FIN WHALE				
Stage	Pregnancy month	Glove-finger	External auditory meatus	Blind section
I	3	White (transparency)	White	—
	4	"	"	—
II	5	Pinkish-white	Pinkish-white	—
	6	"	"	—
III	7	Light-brown	Light-brown, Black antero-dorsal portion	—
	8	Dark-brown	Dark-brown	Yellow
	9	"	"	Yellowish-white
IV	10	Dark-brown	Dark-brown	"
SEI WHALE				
Stage	Pregnancy month	Glove-finger	External auditory meatus	Blind section
II	5	Pinkish-white	Pinkish-white	—
	6	"	"	—
	7	"	" , Black antero-dorsal portion	—
III	8	Light-brown	Light-brown	—
	9	Dark-brown	Dark-brown	—
IV	10	Black	Black	—
HUMPBACK WHALE				
Stage	Pregnancy month	Glove-finger	External auditory meatus	Blind section
II	6	Pinkish-white	Pinkish-white, Black antero-dorsal portion	—

The colour on the internal wall of external auditory meatus is very similar to that on the surface of the glove-finger but it becomes black at stage III particularly in the antero-dorsal portion. The black portion tends to extend gradually to other part of the external auditory meatus. The black part occurs in stage II for sei and humpback whale foetuses.

In the early foetal month, the colour on the surface of glove-finger depends on the thickness of connective tissue and the abundance of blood capillaries or blood vessels. However the brown colour over stage III indicates the occurrence of adhesive materials on the surface of the glove-finger and of the internal wall of the external auditory meatus. In fact, the original colour of the glove-finger and the external auditory meatus appears again after scraping these materials off. From

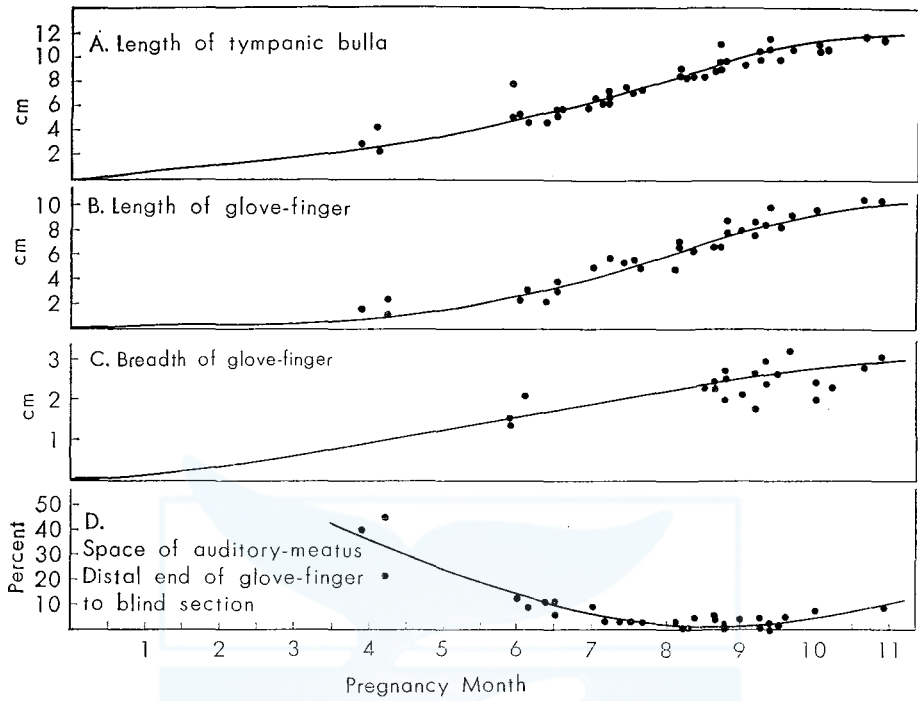

Fig. 1. Growth of tympanic bulla, glove-finger and external auditory meatus in the fin whale foetus from the Antarctic.

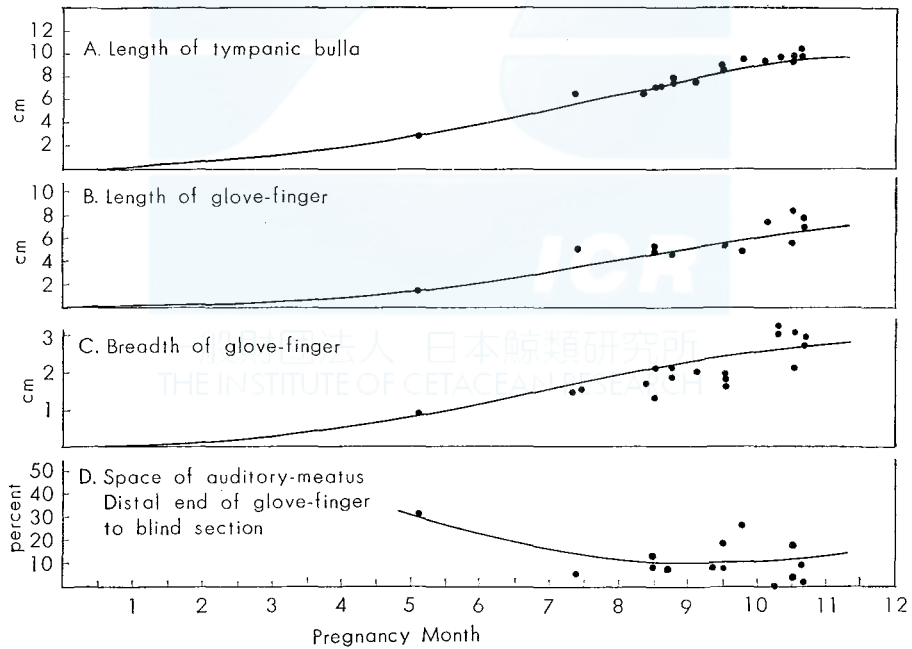

Fig. 2. Growth of tympanic bulla, glove-finger and external auditory meatus in the sei whale foetus from the Antarctic.

the naked-eye observation, the horny layer of foetal epidermis seems to be accumulated from 7th foetal month for fin whales and from about the 8th foetal month for sei whales. In fin foetuses, the yellow adhesive materials are observed on the blind section of the auditory meatus over the 8th foetal month. These materials develop into ear plugs and observed by the naked-eye as various shapes in the latter half of the 9th foetal months.

To examine the transformation of the glove-finger, its length and greatest breadth were measured. The measurement of the distance from the distal end of the glove-finger to the blind section of the external auditory meatus was needed for examining the mechanism which the prenatal ear plug is preserved throughout the life span of whale. Fig. 1 indicates the relation between the development of the glove-finger and that of the external auditory meatus. The shape of glove-finger changes from the early to the late foetal stage. The length of glove-finger from its distal end to the end of tympanic ligament increases rapidly after 4th or 5th foetal months for the fin and sei whale. Until the middle foetal stage, the greatest breadth is indefinitely measured but estimated to grow in the same way as the increment of length. As shown in Fig. 1, the length of tympanic bulla, which is a bony tissue closely connected with the glove-finger, also increases in a sigmoid curve in the foetal stage. The size of the tympanic bulla seems to increase slightly in the postnatal stage, while the growth of the glove-finger is completed in the late foetal stage. Although the size of the sei whale glove-finger is different from that of the fin whale, the growth pattern is about the same between two species (Fig. 2). This observation may be applied to the other baleen whales.

The relation between the glove-finger and the external auditory meatus is of most importance to pursue the prenatal development of the ear plug. In fin whale foetuses the space between the blind section of the external auditory meatus and the glove-finger is large in the early stage. At each foetal month, the relative value of the space changes as indicated in the lowest in Figs. 1 & 2. The space in these figures represents the length from the distal end of the glove-finger to the blind section of the external auditory meatus. If the relative value of the space is expressed as a percentage of the length of the auditory meatus from the proximal end to the blind section, it distributes along the concave curve with the developing foetal month. The external auditory meatus is closely connected with the glove-finger at its proximal end. In fin whales the relative space exceeds 40 percent under the 4th foetal month and approaches to zero percent from the 8th to 9th foetal months, when some foetuses have no space between the blind section and the glove-finger. In the late foetal month, it increases again and is supposed to extend rapidly at the postnatal stage. In fact the external auditory meatus of the adult whale is elongated along the squamosal region of the large skull. This change of space also is drawn in Fig. 3.

On the other hand the sei whale foetus has a fairly larger space in the 8th, 9th and 10th foetal months, compared with the fin whale foetus. The space is 10 percent in these foetal stages, as shown in the lowest of Fig. 2 and there is only one foetus having no space. The change of space in Fig. 1 & 2 represents an evidence that the development of the external auditory meatus is not proportionate to that

of the glove-finger in the foetal stage. In two humpback whale foetuses, relative values of spaces are 29.6 and 44.4 percent but these foetuses are in the 6th foetal months. This evidence probably is expanded for the other species of the balaenopterid whale than fin, sei and humpback whales.

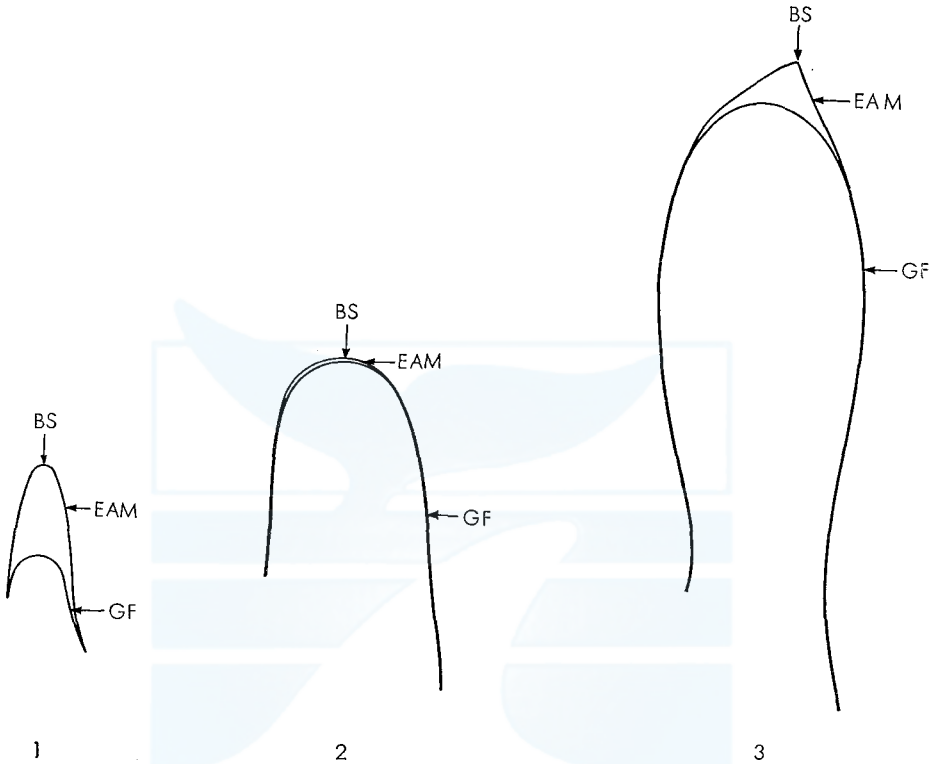

Fig. 3. Relation between the glove-finger and the external auditory meatus in the developing foetus of the fin whale.

1. The 4th foetal month BS : Blind section
2. The 7th foetal month EAM : External auditory meatus
3. The 10th foetal month GF : Glove-finger

In fin whale foetuses the external auditory meatus becomes to cover the outside of the glove-finger after the keratinized epidermal cells was accumulated. Therefore, the prenatal plug-core of the fin whale is surrounded by the keratinized layer derived from the epithelium of the external auditory meatus. The mechanism that the prenatal ear plug is preserved for the all life of fin whales is interpreted from this finding. In most of sei whale foetuses, the external auditory meatus does not surround the surface of the glove-finger throughout the foetal stage. The prenatal ear plug, therefore, is unstably accumulated. In fact, it is very difficult to find the prenatal layer in the ear plug from the adult sei whale. At the distal end of the plug-core, it is easily separated from the outer covering. The practical collection of whole ear plugs to evaluate the age is difficult for the sei whale.

From the presence of the prenatal ear plug and space of the external auditory meatus, baleen whales are divided into two categories. The one includes the ear plugs from blue, fin, Bryde's and humpback whales. In the most of these whales, prenatal ear plugs are preserved completely throughout the life span. The other contains the ear plugs from sei and minke whales, in which prenatal layers are indistinguishable. In the former category, the shape of prenatal ear plug depends upon the shape of space between the glove-finger and the internal wall of the external auditory meatus near the full foetal month. I draw the shape of the prenatal ear plug of the fin whale in Fig. 4. The ear plugs accumulated at the distal end of the glove-finger develops according to the shape of the increasing space after the 8th foetal months.

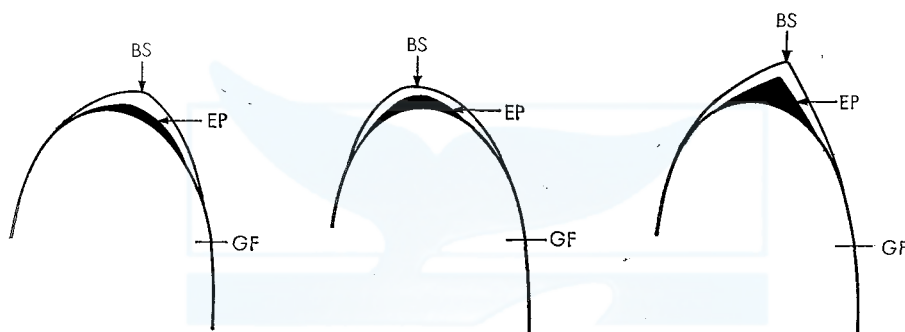

Fig. 4. Shapes of ear plug in the late foetal stage of the fin whale. It correlates with the shape of space from the distal end of glove-finger to the blind section of external auditory meatus.

- BS: Blind section of external auditory meatus.
- EP: Ear plug.
- GF: Glover-finger.

There are various kinds of shapes in the prenatal ear plugs. The most dominant shape is crescent and the triangular shape sometimes present. Such a finding is applied to blue, Bryde's and humpback whale foetuses. In the ear plugs from adult blue, Bryde's and humpback whales there remain various shapes of prenatal layers.

HISTOLOGY

The study on the formation of prenatal ear plug should be approached by the histological examination. When age of baleen whales are estimated by ear plugs, the core part is more important than the outer-covering (Purves, 1955), although the core and outer-covering constitute so-called ear plugs of baleen whales. The histological examination in this paper, therefore, was focused on the plug-core derived from the degenerated epidermal cells of the glove-finger. Ichihara (1959) points out that the celloidin section suits for the hard materials like the glove-finger and the frozen section for the soft materials like the ear plug. In the foetal stage, how-

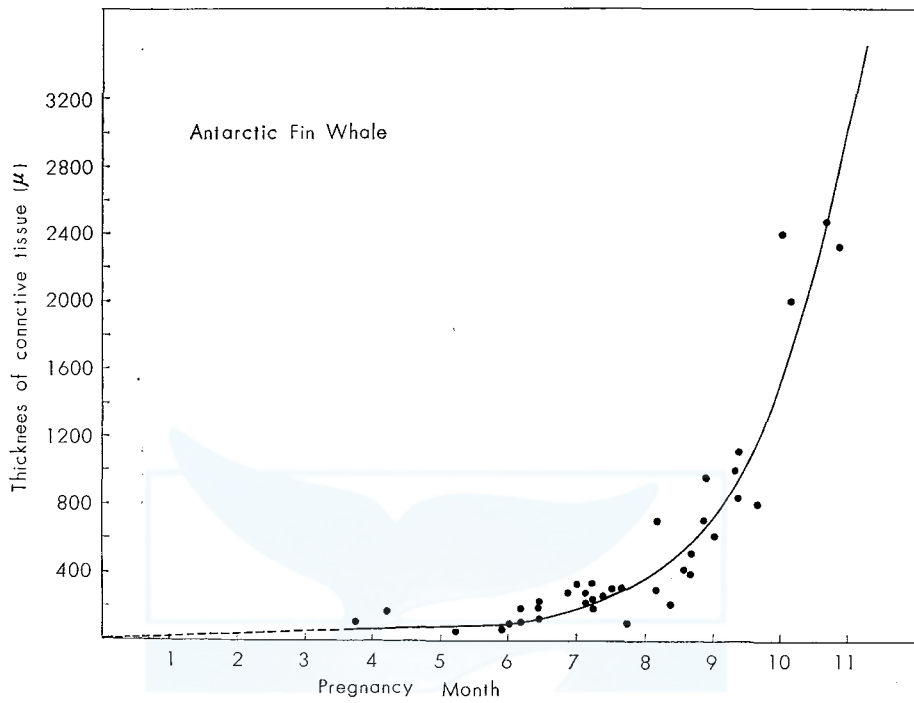

Fig. 5. The increasing thickness of the connective tissue of the glove-finger from the fin whale fetus. The broken line is estimated.

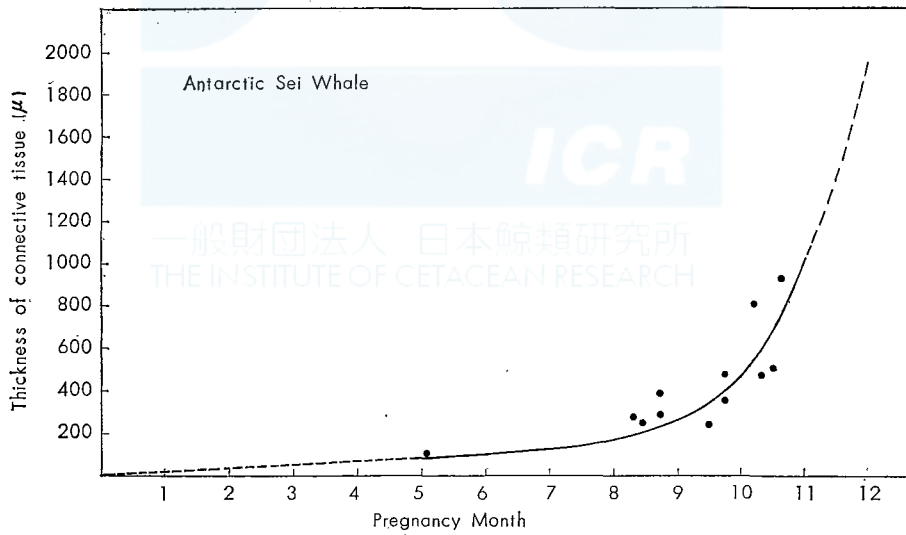

Fig. 6. The increasing thickness of the connective tissue of the glove-finger from the sei whale fetus. The broken line is estimated.

ever, very thin ear plugs are accumulated on the surface of the glove-finger, and hence I used only the celloidin section for this study. On the basis of the section of thickness from 10 to 15 μ , I measured the thickness of the connective tissue of the glove-finger, that of the keratinized layer and fatty degenerated layer of the glove-finger epidermis for each specimen. My observations also are made for the degeneration of nucleus of the germinal layers and for the occurrence of the keratinized layer densely stained by eosin.

Thickness of connective tissue: The thickness of the connective tissue was measured between the basal layer of the outer epidermis and that of the inner one of the glove-finger. As papillary layers undulate slightly after the 6th foetal months, the mean value is obtained from several measurements for each specimen. The thickness of the connective tissue is plotted against each foetal month of the fin whale as shown in Fig. 5. The broken line is estimated in the figure, because available data are insufficient. There is a suitable straight line for the increasing thickness until about the 6th foetal month and then the thickness grows rapidly until the full foetal month. Just after birth, the thickness of the connective tissue approaches to about 2900 μ , the mean value for the adult fin whale.

The thickness of the connective tissue represents the same increment for the sei whale foetus but it is thinner than for the fin whale foetus as, indicated in Fig. 6.

Keratinization: A specimen from the 3 3/4 to 4th foetal months is covered with two layered epidermis. The outer layer, the periderm, constitutes a protective covering although the nucleus is in a depressed form (see Plate I, Fig. 1). The basal layer of early embryo is composed of low cuboidal cells with clearly stainable nuclei and a smooth basal surface. With the increasing embryo, the basal cells become columnar with large, darkly stained nuclei and proliferative. Even in a specimen from the 3 3/4 to 4th months, the compact basal layer is covered by periderm cells, some of which are exfoliating.

In the human embryo, a stratum intermedium, proliferated from the basal layer develops between the basal layer and periderm at about the 4th foetal months and toward the end of foetal life it, now called stratum spinosum, or prickle cell layer, is several cells thick (Montagna, 1962). These processes also exist in the epithelium of baleen whale foetuses.

The periderm of the foetal glove-finger is stained lightly by eosin. Montagna (1962) states that the keratohyalin granules appear where the epidermis is thickest but the general epidermis has no stratum granulosum at the end of the 5th months in the human embryo and that the keratinization progresses only when the stratum granulosum is formed. The stratum granulosum is not observed definitely in the thick epidermis of the glove-finger from the baleen whale, although it is assumed that the same mechanism as in the man progresses in the keratinization of the whale epidermis.

To examine when the keratinization begins, I measured the thickness from the upper edge of the basal layer to the most distal end of accumulated substance for each specimen from fin whale foetuses and plotted it against each foetal month in Fig. 7. The thickness expressed in such a way certainly includes both the kera-

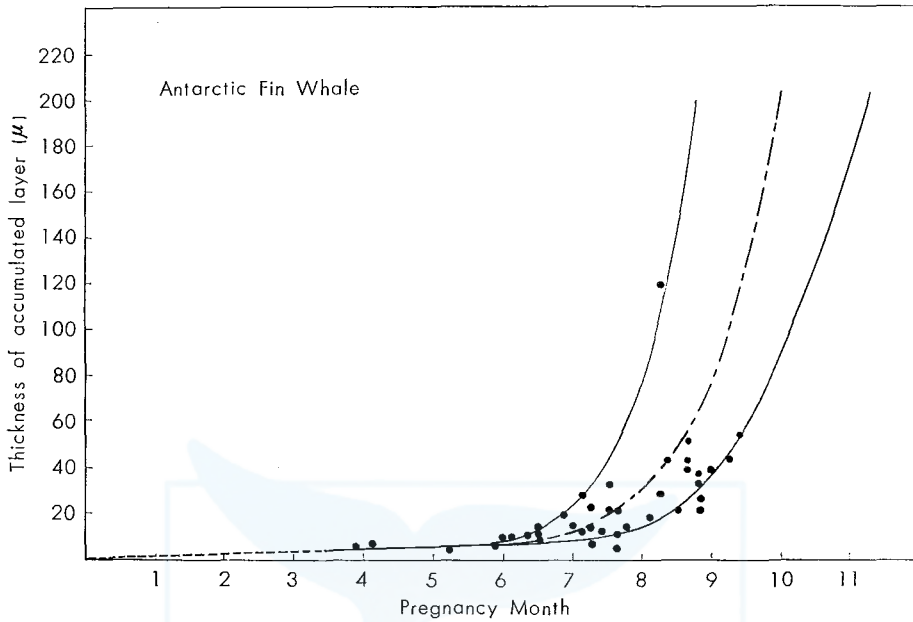

Fig. 7. The increasing thickness of the accumulated layer of the fin whale foetus, including the keratinization and the fatty degeneration layer in the epidermis of the glove-finger. Broken line is estimated and chain line indicates the mean curve.

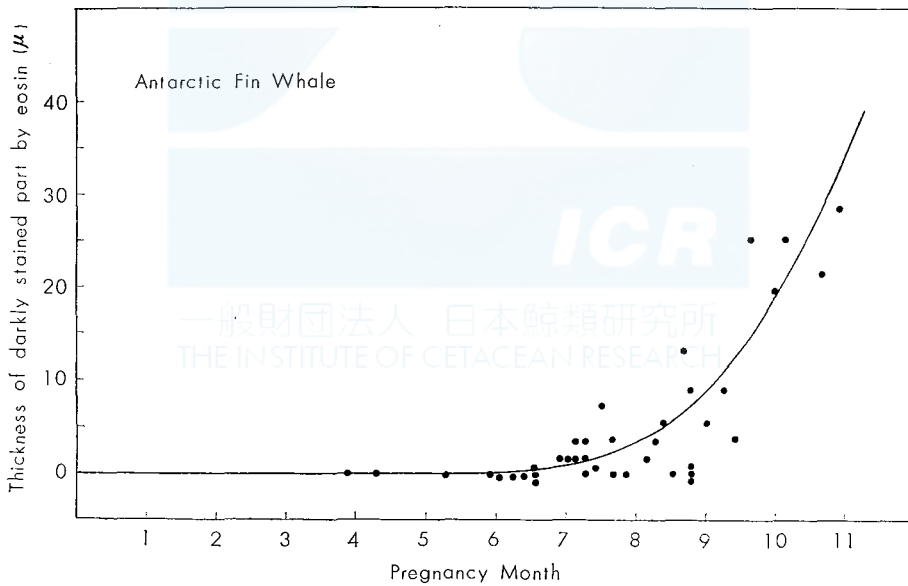

Fig. 8. The increasing thickness of darkly stained part by eosin with the advancement of the foetal month of the fin whale. This part is present at the lowest of keratinized layer.

tinized layer and the fatty layer described later. Therefore, the thickness of keratinized layer will be obtained by subtracting the fatty layer from total accumulated layer. It is difficult to examine accurately the primitively keratinized cell from the prickle cell layer in the late foetal stage.

Fig. 7 indicates the accumulation speed in the fin whale foetus. From fertilization to the 6 1/2 foetal months, the accumulation progresses in a constant ratio, although it is estimated by the broken line in the early foetal stage from fertilization through the 3rd foetal month. After the 6 1/2 foetal months, the accumulated layer is rapidly thick but there are great variations for individual specimens. An accumulated layer from one specimen of the 8 1/4–8 2/4 foetal months is 119 μ thick, while that from another specimen of the same foetal month is 28 μ thick. As the external auditory meatus covers the surface of the glove-finger after the 8th foetal months, it is difficult to examine the whole accumulated layer only from sections of glove-fingers. The prenatal ear plug, disconnected from the surface of glove-finger, indicates various heights. The values of the keratinized layers are about 4300 μ for a specimen from the 9 2/4–3/4 foetal months, about 850 μ for that from the 10–10 1/4 foetal months and about 3800 μ for that from the 10 3/4–11 foetal months.

These variations probably depends on the activity of the mitotic division on the prickle-cell layer or the basal layer of the epidermis. There are also great variations for the lengths of plug-cores from adult fin whales (Nishiwaki, Ichihara & Ohsumi, 1958; Purves & Mountford, 1959).

The germinal layer also becomes thick rapidly after the 6th foetal months and is maintained for the late foetal month. Probably the thickness of the germinal layer and hence the number in stratified cells, also will be kept in the postnatal life.

At the same, the layer stained darkly by eosin begins to occur in the distal end of the accumulated layer as indicated in Plate II, Fig. 1 & III, Fig. 1. This darkly stained layer is thick with the growing foetuses and reaches about 40 μ in thickness at birth. The increment of this layer for examined specimens is plotted against each foetal month of the fin whale in Fig. 8. Although the periderm in the early foetal stage appears to undergo cornification, it probably does not mean the keratinization. The occurrence of darkly stained layer seems to indicate the keratinization in the epidermis of the glove-finger.

In the sei whale foetus as well as in the fin whale foetus, the darkly stained layer occurs when the accumulation ratio increases rapidly. Fig. 9 shows the increasing thickness of total accumulated layer against each foetal month of the sei whale, although available specimens are insufficient. The keratinization in the epidermis of the glove-finger arises at the 8 1/2 foetal months of the Antarctic sei whale.

For the sei whale foetus, there is a divergence between the growth curve by obtained by Matthews (1938) and that indicated by Laws (1959). Interpretation by Matthews results from the Antarctic sei whale, while Laws has his conclusion on the basis of the North Pacific sei whale, therefore, the divergence may be derived from the localities of sei whales. In determining the foetal month of the sei whale, I adopted Laws' finding, because his curve fits the growth patterns of other balaenopterid whales. I am afraid, however, the keratinization for the Antarctic

sei whale foetus occurs slightly earlier than the 8th foetal month. There are also great variations in the thickness of the keratinized layer for the individual foetus of the sei whale. In the 10 1/2 foetal months, an accumulated layer from a specimen is 273 μ thick, while that from another specimen is 35 μ thick.

The keratinized layer in the foetal stage remains in the ear plug of the adult baleen whale. Plate V indicates the presence of the prenatal keratinized layer, appearing at the most distal end of the plug-core, outside of the prenatal fatty layer for various baleen whales. The prenatal keratinized layer is observed more clearly in the fin, blue, Bryde's and humpback whale than in the sei and minke whale.

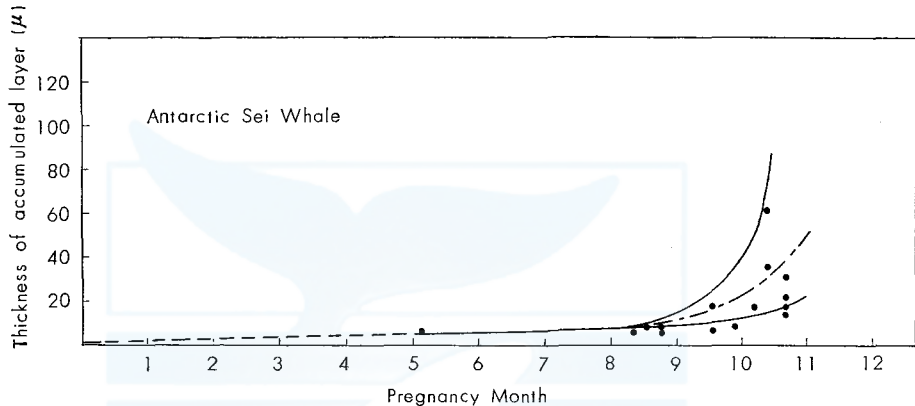

Fig. 9. The increasing thickness of the accumulated layer of the sei whale foetus, including the keratinatin and the fatty degeneration layer in the epidermis of the glove-finger. Broken line is estimated and chain line indicates the mean curve.

Fatty degeneration: The germinal layer becomes thick with the advancement of the foetal month and composed of cells in several layer at the 6 1/2 foetal months. The outside prickle-cell layer continue to degenerate into the keratinized cells from the 6 1/2 to the 8th foetal months, when slightly swelled cells in the prickle-cell layer sometimes contain lipoid granules in their cystopasms. This indicates the occurrence of fatty degenerated cells in the epithelium of the glove-finger. The fatty degeneration progresses rapidly in the whole prickle-cell layer in larger foetuses after the 8th foetal months. The cystoplasms filled with lipoid granules develop into the fatty layer which is removed outwards by the pressure of newly degenerated fatty cells. The accumulation processes of fatty layers are clearly indicated in Plate III, Fig. 1 & 2 and IV, Fig. 1 & 2. From the 10th to 11th foetal months of the fin whale, the fatty layer is from 33 μ to 130 μ thick and estimated rapidly thick at birth.

As the fatty layer remains on the surface of glove-finger, its thickness can be measured accurately through the section. Fig. 10 indicates the increment of fatty layer against each foetal month of fin whales. The thickness of the fatty layer is measured between the lower border of the keratinized layer and the basal layer of the glove-finger epidermis. According to this figure, the fatty degenerated cells

appears at the 8th foetal months and the fatty layer develops over 180 μ in thickness for 3 1/4 month until the birth of the fin whale foetus. Through the microscopic examination, my previous finding (1959) can be applied to the process of fatty degeneration in the prenatal ear plug. This suggests that the fatty degeneration passes through the same mechanism in the prenatal as well as in the postnatal ear plugs.

In specimens from sei whale foetuses, fatty granules are found for the first time in the cytoplasm of degenerated cells in the 10 1/4 foetal months. Although a few specimens do not represent the rigid finding, it is assumed that sei whale foetuses develop more thin fatty layer than do fin whale foetuses.

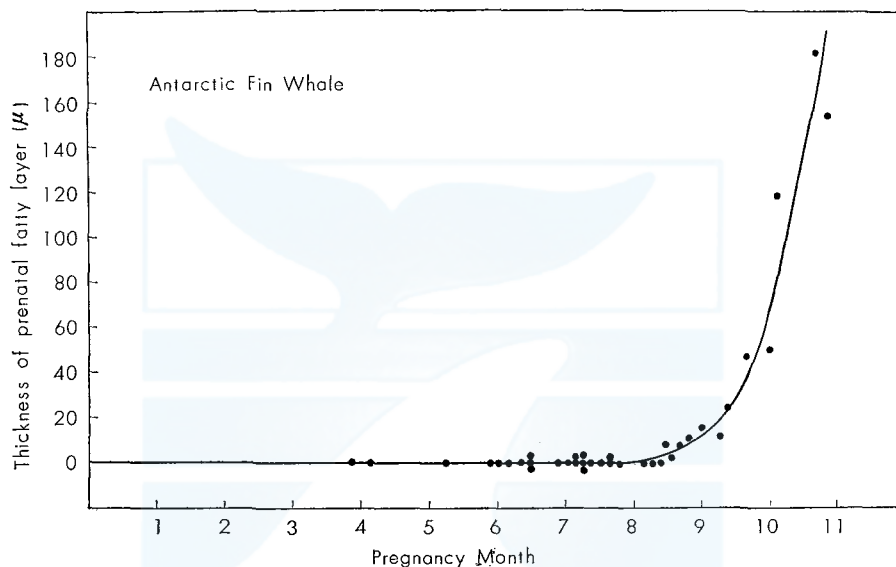

Fig. 10. The increasing thickness of the prenatal fatty layer of the fin whale, composed of fatty degenerated cells in the epidermis of the glove-finger.

By the naked eye observation, these fatty layers remain at the distal end of all ear plugs from fin, blue, Bryde's and humpback whales, therefore, it can be recorded by the photometric method (Ichihara, 1962). Prenatal fatty layers of ear plugs from various kind of baleen whales are indicated Plate V ; Figs. 1, 2, 3, 4 & 5.

The longitudinal fatty layer is absent in the keratinized layer of the prenatal ear plugs. In the bisected specimen of the ear plug from the adult baleen whale, the longitudinal fatty layer is clearly present at the concavity in the epidermis corresponding to the undulate papillae in the derma of the glove-finger. In the postnatal ear plug, furthermore, the longitudinal fatty layer becomes more clear near the proximal end with the advancement of the whale age. This is primarily because the papillae of derma project outwards with the increasing age of the whale, although there are individual variations in its degree. The absence of the longitudinal fatty layer in the prenatal stage is based on not only the comparatively flat surface of papillae but also the unique process in which the keratinized fusiform cell is nearly

the same size as the fatty degenerated cell. This feature is shown in Plate IV, Fig. 2. The transformation of degenerated cell in the ear plug from the adult whale was already described (see Fig. 9, Ichihara, 1959). The physical force during the development of ear plug effects intensively on the formation of the longitudinal fatty layer. This will be examined in connexion with the renewal time of epidermal cells in the future study.

DISCUSSION

Laws & Purves (1956), examining ear plugs from young fin whale captured at the norwegian coast, confirm their earlier conclusions about initial stages in the formation of the plug. They continue their statements that the first lamination which is always a small, conical, unstratified body rich in calcium, is deemed to be that part of the plug which is present in the ear before birth. It is vague what they mean by the first lamination, but the unstratified body probably indicates only the fatty layer described in the previous chapter of this paper. There are, however, two layers in the ear before birth, composed of dark and bright layers.

Chittleborough (1959) reports that only the secretory membranes were found when the ear plugs from near-term humpback whale foetuses were dissected out, and he considers that the first lamination of the ear plug is laid down soon after birth. Although he disagrees with the presence of prenatal ear plug in the humpback whale, I suppose that his finding depends on examining the surface of the glove-finger on which the collapse of prenatal keratinized and fatty layer has already progressed. With the increasing time from kill to flensing, the new ear plug rich in keratin undergoes decomposition and hence it is disconnected from the surface of the glove-finger, even in adult baleen whales. I confirmed the presence of the prenatal ear plug for a near-term humpback whale foetus taken off Ryukyu Islands, as reported in my previous paper (Ichihara, 1959). Besides in this paper I reconfirm the occurrence of degenerated epidermal cells in glove-fingers from two Antarctic humpback whale foetuses. Crisp (1963) discusses the effect of adult whale length and post-mortem time on ease of removing ear plugs from fin whales and concludes that there is a significant difference in the success of extraction between the whales with post-mortem times of less than 7 hours and those that had post-mortem times of more than 7 hours. There is a positive relationship between the ease of removing ear plugs and the decomposition of their tissues, however, the technical ease is different from the accurate examination on the ear plug. Histological examinations need the fresh materials.

The development of baleen plate should be noticed here. The periodic growth of the cortical layer sheathing the medullary layer in the baleen plate has been an indicator of age of baleen whales since Ruud (1940) pointed its significance. The cortical layer is formed by the cornification of cells from the lateral surfaces of the blade-pulp, while the medullary tissue is formed from the lower and inner margin (Eschricht & Reinhardt, 1866 ; Tullberg, 1883). Citing Tullberg's paper, Mackin-

tosh and Wheeler (1929) states that the first rudiments of the two blocks of baleen plate are found after the blue whale foetus reaches a length of 2 metres or more and then two plain strips of a soft whitish material appear, one on each side of the upper jaw. They state, furthermore, that at the 2.5 to 3 metres, minute transverse ridges appear on these strips and later develop into whalebone plates. With regard to fin whales, Mackintosh & Wheeler describe that the development of the baleen in the blue whale foetus applies equally to its development in the fin whale foetus. Ohsumi (1960) reports that the first rudiments of the baleen plates are found at the length of 1.75 metres in the Antarctic fin whale foetus.

According to the foetal growth curve of baleen whales, indicated by Laws (1959), the length of 2 metres in the blue whale and that of 1.75 metres in the fin whale correspond to the 7th foetal months. The occurrence of rudiments of baleen plates does not yet indicate the keratinization of cells from lateral surfaces of the blade-pulp.

The evidence that the keratinized cells in the epidermis of the glove-finger appears at the 6 1/2 foetal month of the fin whale supports the finding that steps in the prenatal development of keratinized cells depend on various tissues of the whale body. The keratinization might be more precocious in the epidermal cells of the glove-finger than those of the other tissues, however, it is necessary to reexamine the significance underlying in the comparison between the periodic mark on the baleen plate and the laminae number in the ear plug, because these two age indicators for baleen whale is formed primarily from the keratinization of cells.

In the prenatal stage of fin whale, the fatty degenerated cells appears from the 8th foetal months and develops until birth. The prenatal fatty layer in the other baleen whale enables us to discriminate it from the postnatal accumulation of the ear plug. A sudden turn of the epidermal cells from the keratinized to the fatty degeneration can not occur without the internal stimulation of the body. In the foetal stage, it is the most reasonable to accept the endocrinal stimulus through the blood supply from the maternal body. Although enzymes act as catalysts in the regulation of metabolic processes, hormones *in vivo* exert their influence by acting indirectly upon the enzymes which catalyze the particular reaction (Rothman, 1954).

The season when the fatty degeneration arises in the maternal ear plugs will be examined in relation to the physiological rhythm in the future study, through which the relation between the biological clock and the calendar period will be clarified.

The neonatal line of the ear plug is defined as the part where the formation of the prenatal fatty layer ends.

SUMMARY

In the course of my continuous study on the accumulation of the ear plug, the most reliable material to determine the age of baleen whales, I examined the prenatal development of ear plug by using foetal specimens from 48 fin whales, 17 sei whales and 2 humpback whales in the Antarctic. The foetal growth curve by Laws (1959)

is applied in this paper to obtain the accurate foetal month for the examined specimens. Through the naked eye observation during dissecting the external auditory meatus from the blind section to the glove-finger and through the histological examination on the celloidin section of the glove-finger, my findings are summarized as follows.

1. The shape of prenatal ear plug is determined by the difference in growth between the external auditory meatus and the glove-finger in the foetal stage of baleen whale. With regard to shapes, there are individual variations in the same species as well as the specific differences among baleen whales.

2. The prenatal ear plug is essentially maintained throughout the life span of the baleen whale. It is observed clearly in the ear plugs from the adult blue, fin, Bryde's and humpback whales but rarely in the ear plugs from adult sei and minke whales. In the sei and minke whale, the connection between the ear plug-core and the outer-covering is so weak that the ear plug is separated at the distal portion of the core in the course of removing ear plugs from the whale bodies. This implies some difficulties in age determination by ear plug for these two species.

3. The keratinization in the epidermal cells of the glove-finger appears at the 6 1/2 foetal month of the fin whale, according to the histological examination. It arises at the 8 1/2 foetal month of the sei whale. The observation by the naked eye for fetuses endorses this finding. The keratinized layer in the prenatal stage, showing great individual variation of thickness, remains as the first dark layer at the distal end of the plug-core.

4. The fatty degeneration in the epidermal cells of the glove-finger occurs at the 8th foetal months and continues to progress until birth in the fin whale. It also appears at the late foetal month of the sei whale. In the adult ear plugs from baleen whales, the fatty layer remains as the first bright layer following the above keratinized layer.

5. The neonatal line of the ear plug is defined as the part where the first bright layer ceases to grow.

6. The longitudinal bright layer is not yet present in the foetal ear plug.

7. The substances stimulating the foetal epidermis of the glove-finger to the fatty degeneration seem to be supplied through the maternal blood. The endocrine factors may act an important part.

REFERENCES

- Chittleborough, R. G. (1959). Determination of age in the humpback whale, *Megaptera nodosa* (Bonnaterre). *Aust. J. Mar. Freshw. Res.*, 10: 125-143.
- Crisp, D. T. (1963). The effect of whale length and post-mortem time on ease of removing ear plugs from fin whales. *Norsk Hvalfangst-Tid.*, 5: 121-123.
- Eschricht, D. F., & J. Reinhardt (1866). On the greenland right whale. Recent memoirs on the Cetacea. Roy. Soc. of London.
- Ichihara, T. (1959). Formation mechanism of ear plug in baleen whales in relation to glove-finger. *Sci. Rept. Whales Res. Inst.*, 14: 107-135.
- (1963). Photometric method for counting laminae in ear pug of baleen whale. *Sci. Rept. Whales Res. Inst.*, 17: 37-48.

- Laws, R. M. & P.E. Purves (1956) The ear plug of the Mysticeti as an indication of age with special reference to the North Atlantic fin whale (*Balaenoptera physalus* Linn.) *Norsk Hvalfangst-Tid.*, 8 : 413-35.
- Laws, R. M. (1959). The foetal growth rates of whales with special reference to the fin whale, *Balaenoptera physalus* Linn. *Discovery Repts.*, 29 : 281-308.
- Mackintosh, N. A. & J. F. G. Wheeler (1929). Southern blue and fin whales. *Discovery Repts.*, 1 : 257-540.
- Matthews, L. H. (1938). The sei whale, *Balaenoptera borealis*. *Discovery Repts.*, 17 : 183-290.
- Montagna W. (1962). *The structure and function of skin*. Academic press, New York. : 1-454.
- Nishiwaki, M., T. Ichihara & S. Ohsumi (1959). Age studies of fin whale based on ear plug. *Sci. Rept. Whales Res. Inst.*, 13 : 155-169.
- Ohsumi, S. (1960). Relative growth of the fin whale, *Balaenoptera physalus* (Linn.) *Sci. Rept. Whales Res. Inst.*, 15 : 17-84.
- Purves, P. E. (1955). The wax plug in the external auditory meatus of the Mysticeti. *Discovery Repts.*, 27 : 293-302.
- Purves, P. E., & M. D. Mountford (1959). Ear plug laminations in relation to the age composition of a population of fin whales (*Balaenoptera physalus*). *Bull. Brit. Mus., (Nat. His). Zool.*, 5 : 125-61.
- Rothman, S. (1954). *Physiology and biochemistry of the skin*. The University of Chicago press. Chicago ; 1-741.
- RUUD, J. T. (1940). The surface structure of the baleen plates as a possible clue to age in whales. *Hvalrådets Skrifter.*, 23 : 1-23.
- TULLBERG, T. (1883). Bau und Entwicklung der Barten bei *Balaenoptera sibbaldii*, *Nova Acta Soc. Sci. Upsal.*, ser. III, 11 : 1-36.

APPENDIX. THE BIOLOGICAL DATA FOR EXAMINED FOETUSES

FIN WHALE

No.	Date obtained	Foetal length in cm	Foetal month	Sex in foetus	Elapsed time after killing	No. of ovulation in mother's ovaries	Position captured
1	9, Jan. 1960	6.6	3/4-1	F	9-20	11	56°-19'S, 94°-56'E
2	4, Jan. 1960	19.0	1-3/4	F	12-40	25	57°-07'S, 100°-23'E
3	6, Jan. 1960	47.5	2 3/4-3	F	11-10	25	56°-34'S, 95°-09'E
4	26, Jan. 1960	52	3	M	7-10	7	60°-55'S, 153°-01'E
5	7, Jan. 1960	71	3 3/4-4	M	5-15	13	56°-26'S, 92°-57'E
6	29, Dec. 1959	79	4 1/4	F	7-40	2	58°-36'S, 92°-27'E
7	29, Jan. 1960	117	5 1/4	F	8-25	4	59°-31'S, 150°-14'E
8	28, Dec. 1959	122	5 3/4-6	M	6-20	14	59°-12'S, 94°-24'E
9	8, Jan. 1960	122	5 3/4-6	M	11-35	5	57°-00'S, 93°-36'E
10	30, Dec. 1959	127	6	F	2-55	9	57°-54'S, 93°-45'E
11	2, Feb. 1960	130	6-6 1/4	M	7-50	1	59°-32'S, 150°-47'E
12	23, Jan. 1960	140	6 1/4-6 2/4	F	6-50	22	62°-21'S, 146°-12'E
13	24, Jan. 1960	145	6 2/4	F	8-15	13	61°-43'S, 150°-17'E
14	30, Jan. 1960	145	6 2/4	F	12-15	11	59°-14'S, 148°-44'E
15	9, Mar. 1960	145	6 2/4	M	5-00	7	60°-54'S, 150°-57'E
16	10, Jan. 1960	165	6 3/4-7	M	11-40	7	56°-16'S, 92°-19'E
17	12, Feb. 1960	173	7	M	11-00	1	68°-24'S, 168°-12'W
18	31, Jan. 1960	175	7-7 1/4	M	6-15	2	60°-48'S, 148°-52'E
19	2, Feb. 1960	175	7-7 1/4	F	1-35	5	59°-32'S, 150°-47'E
20	11, Jan. 1960	183	7 1/4	M	9-35	3	57°-19'S, 91°-29'E
21	21, Jan. 1960	183	7 1/4	F	7-45	3	63°-16'S, 140°-23'E
22	22, Jan. 1960	183	7 1/4	F	12-45	2	62°-12'S, 144°-06'E
23	19, Jan. 1960	191	7 1/4-7 2/4	F	10-10	21	64°-06'S, 126°-32'E
24	28, Dec. 1959	203	7 2/4	M	5-25	19	59°-12'S, 94°-24'E
25	30, Jan. 1960	206	7 2/4-7 3/4	M	10-50	2	59°-14'S, 148°-44'E
26	29, Dec. 1959	219	7 3/4	M	5-50	14	58°-37'S, 92°-26'E
27	21, Jan. 1960	242	8-8 1/4	F	7-05	19	63°-16'S, 140°-23'E
28	30, Jan. 1960	252	8 1/4	F	10-30	2	59°-14'S, 148°-44'E
29	4, Jan. 1960	259	8 1/4	F	4-15	13	57°-07'S, 100°-23'E
30	4, Feb. 1960	264	8 1/4-8 2/4	F	4-55	9	59°-48'S, 150°-24'E
31	25, Jan. 1960	269	8 2/4	M	10-05	2	60°-38'S, 153°-56'E
32	30, Dec. 1959	280	8 2/4-8 3/4	M	3-25	12	57°-54'S, 93°-45'E
33	23, Jan. 1960	280	8 2/4-8 3/4	F	5-55	12	62°-21'S, 146°-12'E
34	4, Feb. 1960	292	8 3/4	M	6-05	13	59°-48'S, 150°-24'E
35	12, Jan. 1960	300	8 3/4	F	7-30	27	57°-00'S, 92°-57'E
36	18, Jan. 1960	300	8 3/4	M	11-55	16	64°-19'S, 122°-10'E
37	28, Dec. 1959	323	9	M	3-15	19	59°-12'S, 94°-24'E
38	28, Jan. 1960	338	9 1/4	F	5-55	15	60°-35'S, 150°-36'E
39	29, Jan. 1960	348	9 1/4	M	10-00	17	59°-31'S, 150°-14'E
40	29, Jan. 1960	353	9 1/4-9 2/4	F	12-50	20	59°-31'S, 150°-14'E
41	1, Mar. 1960	353	9 1/4-9 2/4	M	10-20	9	65°-05'S, 171°-48'E
42	25, Jan. 1960	374	9 2/4	F	5-00	10	60°-38'S, 153°-56'E
43	4, Feb. 1960	384	9 2/4-9 3/4	F	5-55	13	59°-48'S, 150°-24'E
44	9, Mar. 1960	424	10	M	13-35	4	60°-54'S, 150°-57'E
45	9, Mar. 1960	437	10	F	8-55	7	60°-54'S, 150°-57'E
46	22, Mar. 1960	440	10-10 1/4	F	1-25	4	59°-31'S, 150°-40'E
47	11, Mar. 1960	531	10 2/4-10 3/4	M	2-20	29	59°-31'S, 150°-35'E
48	22, Mar. 1960	556	10 3/4-11	F	2-05	17	59°-31'S, 150°-40'E

M: Male F: Female

SEI WHALE

No.	Date obtained	Foetal length in cm	Foetal month	Sex in foetus	Elapsed time after killing	No. of ovulation in mother's ovaries	Position captured
1	25, Jan. 1960	84	5-5 1/4	M	9-40	8	60°-38'S, 153°-56'E
2	12, Feb. 1960	153	7 1/4-7 2/4	F	5-25	4	68°-24'S, 168°-12'W
3	7, Feb. 1960	175	8 1/4-8 2/4	M	3-30	4	65°-10'S, 165°-00'E
4	29, Jan. 1960	183	8 2/4	M	8-30	10	59°-31'S, 150°-14'E
5	5, Feb. 1960	193	8 2/4	M	6-05	13	60°-29'S, 153°-46'E
6	7, Feb. 1960	198	8 3/4	M	3-40	8	65°-10'S, 165°-00'E
7	13, Feb. 1960	198	8 3/4	M	5-50	11	69°-01'S, 166°-11'W
8	25, Jan. 1960	242	9 1/4-9 2/4	F	9-00	6	60°-38'S, 153°-56'E
9	27, Jan. 1960	247	9 2/4	F	7-15	13	60°-19'S, 148°-42'E
10	2, Feb. 1960	249	9 2/4	M	9-05	6	59°-32'S, 150°-47'E
11	8, Feb. 1960	264	9 3/4	F	2-45	4	66°-53'S, 169°-22'E
12	12, Feb. 1960	300	10 1/4-10 2/4	M	8-05	6	68°-24'S, 168°-12'W
13	27, Feb. 1960	305	10 1/4-10 2/4	M	0-45	5	66°-43'S, 178°-54'W
14	8, Feb. 1960	315	10 2/4	F	3-50	9	66°-53'S, 169°-22'E
15	22, Feb. 1960	315	10 2/4	M	3-50	10	65°-32'S, 163°-04'W
16	10, Feb. 1960	323	10 2/4-10 3/4	M	4-45	13	69°-31'S, 179°-00'W
17	30, Jan. 1960	325	10 2/4-10 3/4	F	9-35	5	59°-14'S, 148°-44'E

HUMPBACK WHALE

No.	Date obtained	Foetal length in cm	Foetal month	Sex in foetus	Elapsed time after killing	No. of ovulation in mother's ovaries	Position captured
1	21, Jan. 1960	109	6 1/2	M	3-45	8	63°-16'S, 140°-23'E
2	21, Jan. 1960	125	6 3/4	M	7-05	8	63°-16'S, 140°-23'E

M: Male F: Female

EXPLANATION OF PLATES

PLATE I

Fig. 1. The cross section of the glove-finger from the 3 3/4-4th foetal months of the fin whale ($\times 400$). The compact basal layer, covered by periderm cells, some of which are exfoliating. The basal layer is composed of low cuboidal cells.

P: Periderm
BL: Basal layer
CT: Connective tissue

Fig. 2. The cross section of the glove-finger from the 8 1/2-8 3/4 foetal months of the fin whale ($\times 100$). The thick epidermis is much proliferated. The keratinized layer is disconnected from this specimen.

BL: Basal layer
CT: Connective tissue

PLATE II

Fig. 1. The cross section of the glove-finger from the 9 1/4-9 1/2 foetal months of the fin whale ($\times 100$). The keratinized layer darkly stained by eosin, is clearly found at the most outer side of the epidermis. The most part of keratinized layer is disconnected from this specimen.

KDS: Keratinization darkly stained by eosin

BL: Basal layer

Fig. 2. The enlarged photomicrograph for the same specimen ($\times 300$). The lipid granules are found in the cytoplasm of the upper prickle-cell layer. There are many transformed nuclei.

FC: Fatty degenerated cell

PLATE III

Fig. 1. The cross section of the glove-finger from the 10th foetal months of the fin whale ($\times 100$). The fatty degenerated layer is clearly observed. The most part of keratinized layer is disconnected from this specimen.

KDS: Keratinization darkly stained by eosin

BL: Basal layer

Fig. 2. The enlarged photomicrograph for the same specimen ($\times 400$). Swelled cells, undergoing the fatty degeneration, are found at the upper prickle-cell layer. At the most outside of the fatty layer depressed nuclei remain yet. The keratinized layer darkly stained by eosin is found at the most distal end.

FC: Fatty degenerated cell.

FL: Fatty layer.

PLATE IV

Fig. 1. The epidermis from the 10 3/4-11th foetal months of the fin whale ($\times 100$). The lower parts of keratinized layer is on the thick fatty layer.

KL: Keratinized layer

FC: Fatty degenerated cell

Fig. 2. The enlarged photomicrograph for the same specimen indicates the fatty degenerated cells at the prickle-cell layer ($\times 400$). The keratinized cell is about the same size as the fatty degenerated cell.

KC: Keratinized cell

FC: Fatty degenerated cell.

PLATE V

The prenatal layers remaining at the most distal ends of plug-cores from adult baleen whales. Prenatal layers are composed to two layers: keratinized (KL) and fatty degenerated (FL) layers.

Fig. 1. Fin whale ear plug

2. Blue whale ear plug

3. Humpback whale ear plug

4. Sei whale ear plug

5. Bryde's whale ear plug

PKL: Keratinized layer of the prenatal stage

PFL: Fatty layer of the prenatal stage

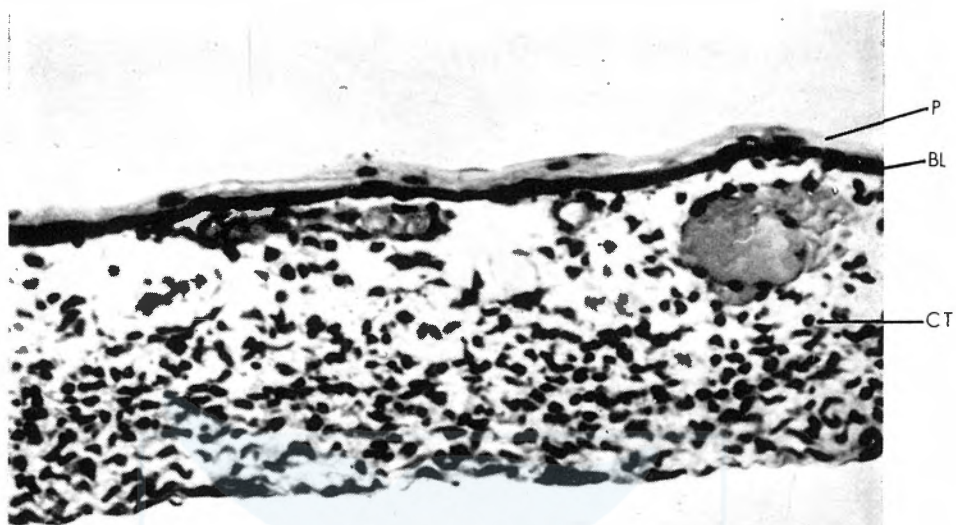

1



2

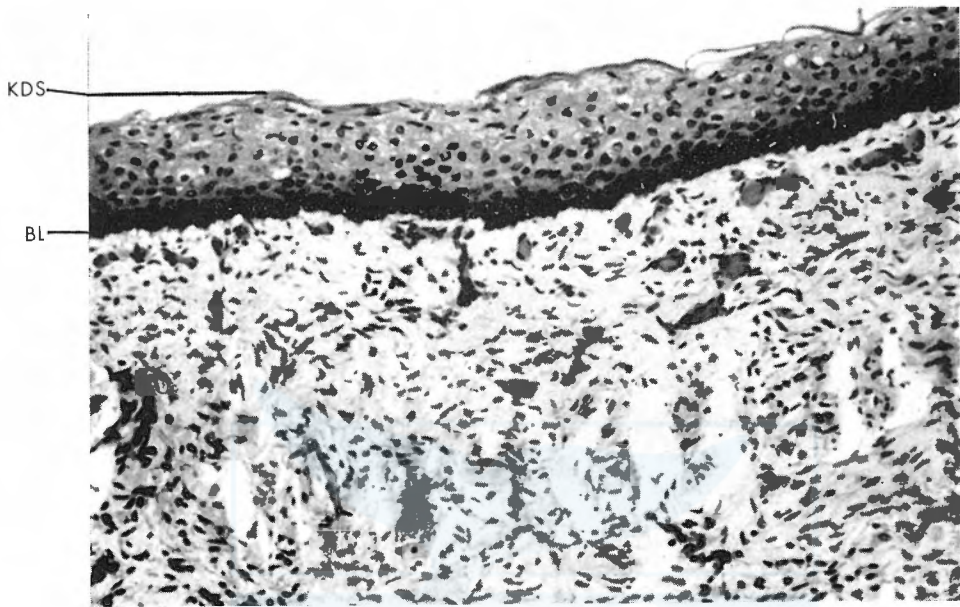

1

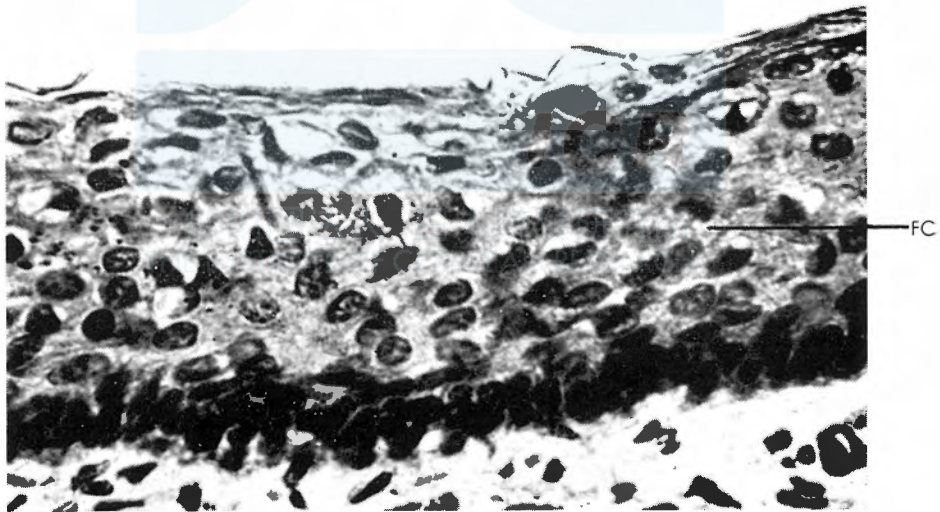

2

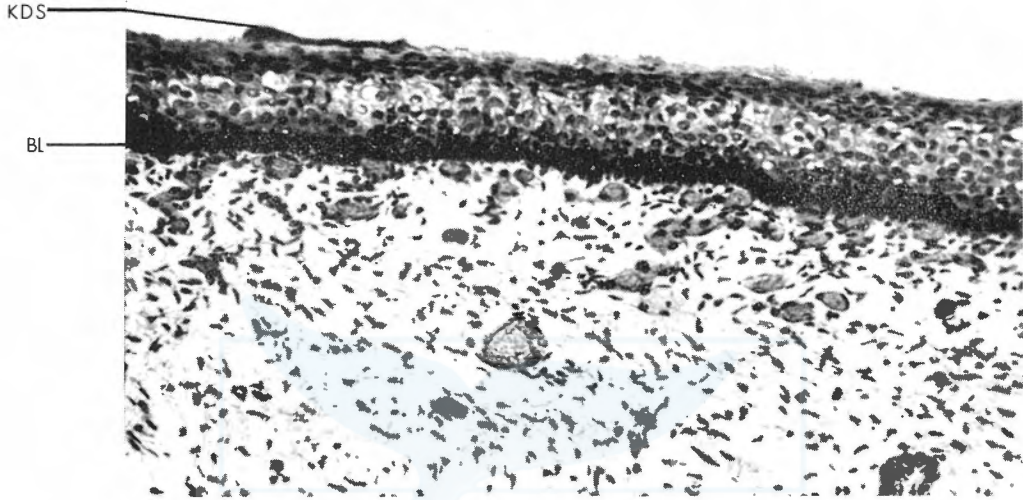

1

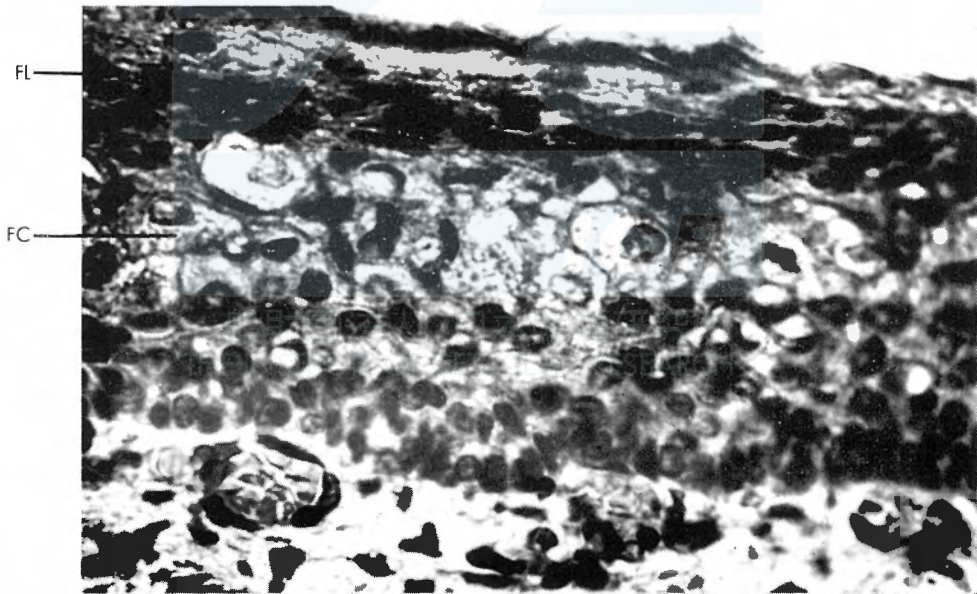

2

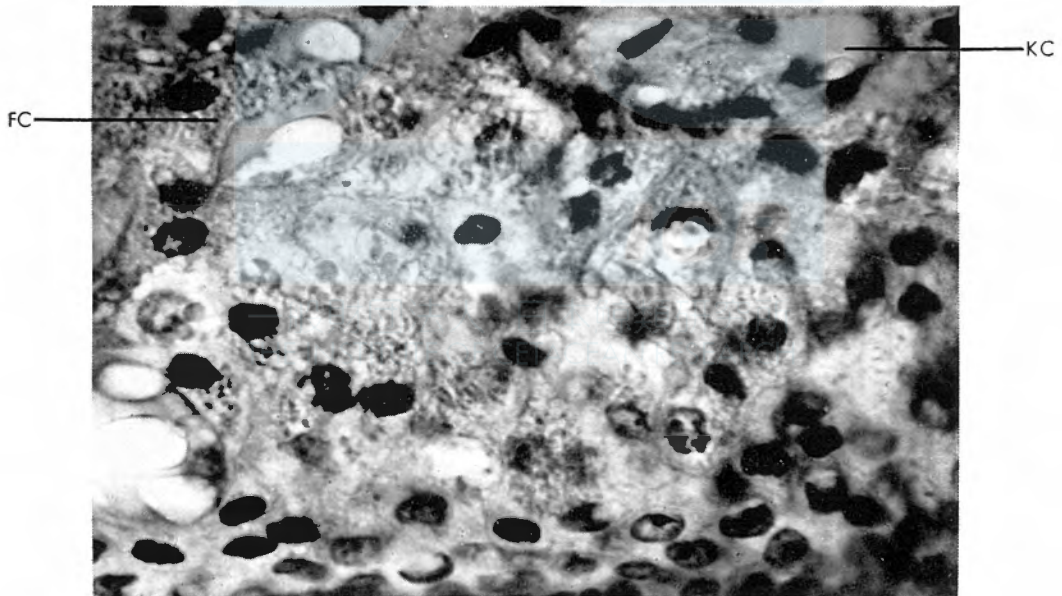
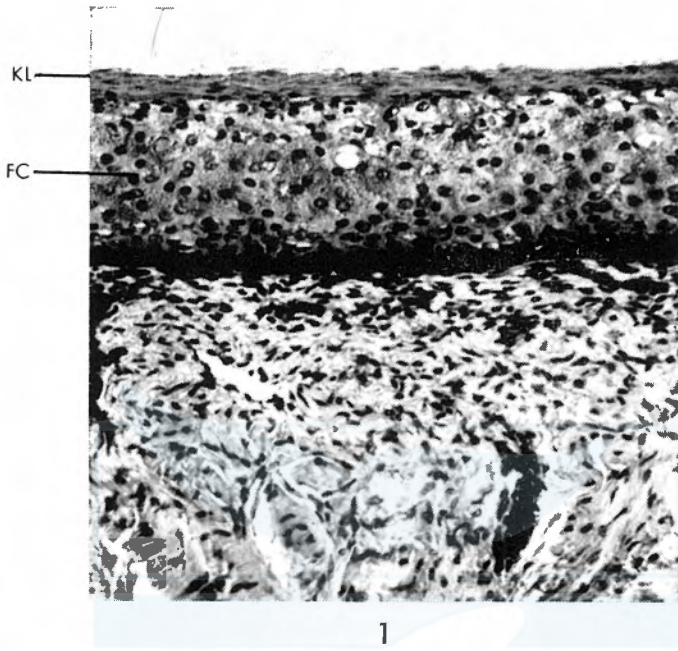

2

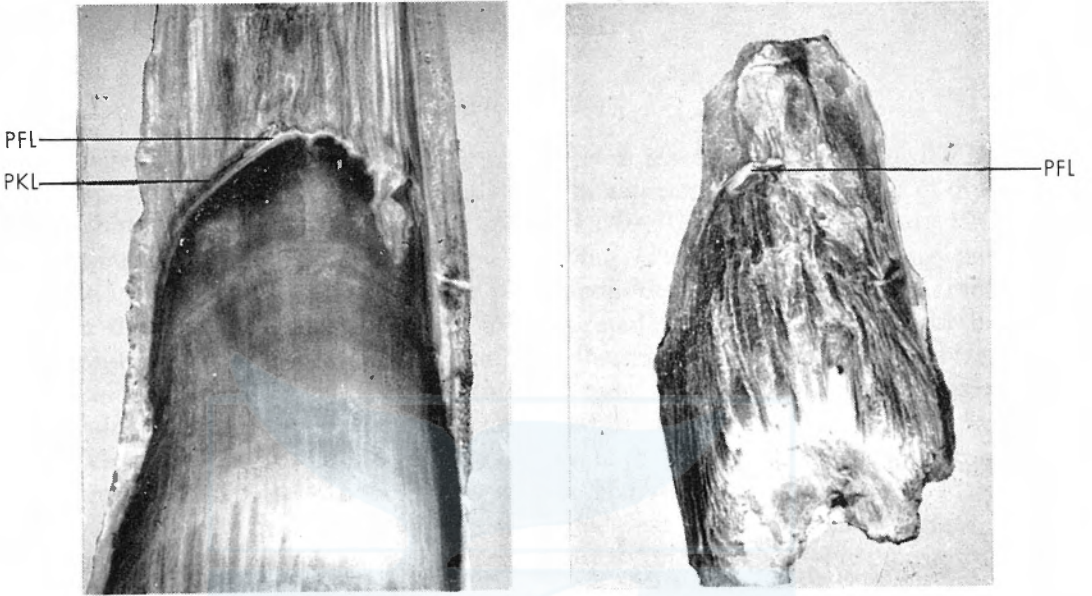

1

2

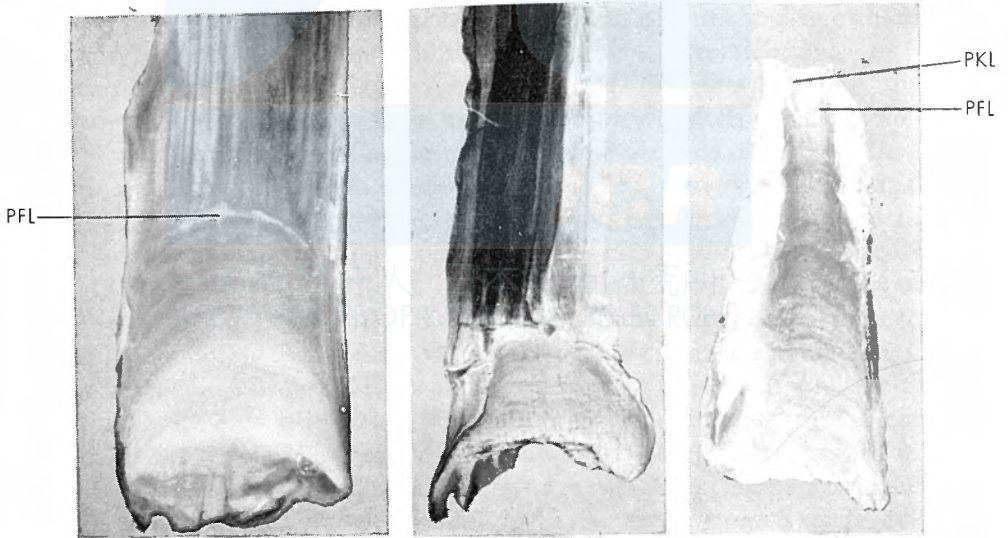

3

4

5

EXAMINATION ON AGE DETERMINATION OF THE FIN WHALE

SEIJI OHSUMI

INTRODUCTION

As the age characters of the fin whale (*Balaenoptera physalus* L.), the following have been reported hitherto. They are body length, stage of growth, number of ovulation, white scars (Mackintosh & Wheeler, 1929), baleen plate (Ruud, 1940), crystalline lens (Nishiwaki, 1950), and ear plug (Purves, 1955). Among them, laminations presented in core of the ear plug is considered as the best age character, because the lamination is considered to be formed periodically, is used for both sexes, and is recognized for all life span. Furthermore, ear plug is relatively easy to be collected and prepared to examine the number of laminations in the core.

Number of corpora albicantia accumulated in ovaries has some weak points as an age character. There is individual variation in the accumulation rate of corpora, and number of corpora is applicable as an age character for only sexually mature females. However, it is useful for age character next to ear-plug lamination, and the data of corpora count have been collected for long seasons. Furthermore the annual accumulation of corpora is also useful for the study of reproductive physiology of the whale.

Ridges presented on the baleen plates is considered to be the most excellent age character of the baleen whales in younger age groups, but unfortunately, it is not able to be used for older age groups.

Now, it is very important to determine age of whale from above age characters, and many hypotheses have been published on the age determination.

Concerning the ear-plug laminations, Purves (1955) first considers that the period of arrested growth corresponds to the migratory periods when physiological demands of active swimming coincide with complete absence of food, so that each lamination represents a growth period of 6 months. Laws & Purves (1956) estimate that the biannual formation of lamination is correct, compared the ear plug with baleen plate for small samples of fin whales. Nishiwaki (1957), Chittleborough (1959), Dawbin (1959) and Laws (1961) did not denied the hypothesis. The hypothesis of biannual formation of lamination now influences on the cetacean biology and population dynamics. However, recently long term marked whales have been recovered (Brown, 1962) and the investigation of ear plug of the recaptured fin whales give a question on the annual accumulation rate of ear-plug lamination (Ohsumi, 1962). Purves & Mountford (1959) state that it is very doubtful whether environmental conditions have any direct influence of the time of formation of the laminae of the ear plug in whales. Since there is strong evidence (not given by them) that lamina formation is in inherent moulting cycle, it is very probable that it takes place whether the whale migrates or not, and Ichihara (1959)

described by the histological examination of ear plug that the effects of hormone and enzyme on the degenerations of epithelial cells of glove-finger were regarded initially, besides, the effect of the environmental factors were presumed indirectly.

There are also many hypotheses on the accumulation rate of corpora albicantia in ovaries. Laws (1958, 1961) reviewed the previous works on the problem. On the fin whale, Mackintosh & Wheeler (1929) plotted the frequencies of corpora, found peaks occurred at 4-5, 12 and 19 corpora, and suggested that these represented the increase in number of corpora at intervals of 2 years. Wheeler (1930) developed this hypothesis by more material, and concluded that about 5 ovulations occur each breeding cycle, or in average 2.5 per year. Peters (1939) reported that he had been able to establish morphological and histological criteria for distinguishing the corpora albicantia representing pregnancy and ovulations, and he estimated that there is an average of 0.9 in a year by counting the pregnant corpora albicantia and assuming a 2-years reproductive cycle. Mackintosh (1942) showed by a marked fin whale recaptured that the annual increment of corpora albicantia had possibility to be less than one. Using the baleen plates as a new method for age determination, Ruud (1940, 1945) suggested that in the breeding season, up to 6-7 ovulations are possible before pregnancy intervenes. Nishiwaki (1952) assumed that the annual increment of corpora albicantia after the first sexually mature age should be 1.5, combining baleen plates, crystalline lens, number of ovulation and sexual and physical maturity.

Since ear plug was discovered as a new method of age determination by Purves (1955), many authors have reported the relation between ear-plug lamination and number of corpora in the ovaries. Nishiwaki (1957) drew a figure on this relation for the Antarctic fin whales and got a result that in average corpora accumulation was 1.2, if ear-plug laminations are formed biannually. Nishiwaki, Ichihara and Ohsumi (1958) drew similar figure as above paper and got that there was individual and racial variation in annual accumulation rate of corpora and in average the annual corpora accumulation rate was 0.9 in the Antarctic fin whale and about 0.8 in the North Pacific fin whales, if ear-plug lamination was formed biannually. Laws studied the annual accumulation rate of corpora albicantia in his valuable paper (1961) from several approaches, and got the annual accumulation of corpora albicantia is 1.43 in average.

And he compared the ages of the fin whales between the age from ear plug (biannual accumulation) and the age from ovary (annual accumulation rate is 1.4), and got the exact agreement between both ages. Fujino (1963) also calculate the corpora accumulation rate per 4 ear-plug laminations from the relation between ear plug and corpora for the Antarctic fin whales separating the areas, and got the result that the rate was 2.80 in Area-II (Laws's result), 2.31 in Area-III west, 1.91 in Area-III east, 1.84 in Areas-IV, and 1.60 in Areas-VI and I respectively. Then, the difference of the annual rate of corpora between Nishiwaki et al. (1958) and Laws (1961) will be caused by the difference of races.

On the age determination of baleen plates, Ruud (1940, 1945), Tomilin (1940, 1945), Nishiwaki (1950 a, 1950 b, 1951, 1952, 1957), Chittleborough (1954,

1959), Laws & Purves (1956) and Laws (1961) all recognize that one ridge grows in one year. Especially Nishiwaki (1952) tried to estimate the annual growth of baleen plates.

Although there are many hypotheses on the age determination of the baleen whales, I think the age determination has not been established. Recently the age characters have been obtained from the long term recaptured fin whales (Ohsumi, 1962). Direct age of recaptured whale is able to be checked by the time from marking till recovery. And examining the recaptured fin whales, above hypotheses are not able to explain some of the actual data. We must re-examine the age determination to solve the actual results on the age characters.

MATERIAL AND METHOD

Several methods were shown to examine the age determination of the whales by Ohsumi, Kasuya & Nishiwaki (1963). Among them breeding experiment as used by Sergeant (1959) and the time marking in the age characters of living animals as used by Nishiwaki & Yagi (1953) are not able to use for the fin whale because of the difficulty of the breeding of the whale. And I have no material for study of the seasonal growth of the age characters as used by Ohsumi, Kasuya & Nishiwaki (1963) on tooth of the sperm whale (*Physeter catodon*).

I examined the age determination in this report by the following three methods. One is the examination of age characters from the recaptured fin whales. The second method is the comparison between each age characters. The third is a population dynamical examination on the age composition based on the ear-plug laminations. Combining the results obtained from above methods, I will examine whether the previous hypotheses are contradictory or not.

Biological material obtained by Japanese fleets from recovered fin whales are based on the data by my previous paper (Ohsumi, 1962).

Baleen plates were collected with ear plug from 74 fin whales in the Antarctic and northern part of the North Pacific, and the ridges appeared on the plates are counted by eye. Ear-plug laminations are counted after the same preparation as by Nishiwaki, Ichihara and Ohsumi (1959).

Ear-plug laminations are counted by the staffs of our Institute using dissecting-microscope. Standardization of the reading ear-plug lamination is need as trying by Ichihara (1963). If the standardization is established and the reading is different to the present reading, my following examinations are needed to be re-examined.

Number of corpora lutea and albicantia were counted with naked eye by slicing the left and right ovaries.

Sexual maturity is determined by the investigation of ovaries or testes. For females, those who have at least one corpus luteum or albicans in their ovaries are determined to be sexually mature. For males, those whose weights of larger side of testes are 2.5 kg or more than 2.5 kg are recognized as sexually mature.

Material for the comparison between ear-plug lamination and other age

characters are all obtained from fin whales caught by Japanese fleets in the Antarctic Areas IV and V in 1958/59 and 1959/60 seasons and northern part of the Pacific during 1959 to 1961 seasons.

Ear-plug laminations are counted from 978 female fin whales caught in the north of east Aleutian Islands in seasons from 1959 to 1961, and the age compositions are drawn in the two cases of annual accumulation rate.

Estimated number of marked fin whales in the north of east Aleutian Islands and the number of recaptured whale from the marked whales are gathered from Japanese whale marking and recovery records during 1954 to 1962.

Number of female fin whales of sexually mature, immature and pregnant are cited from annual reports on the biological investigation of whales caught in the North Pacific from 1954 to 1961.

EXAMINATION OF AGE DETERMINATION BY MEANS OF WHALE MARKING

SOME POINTS TO BE CONSIDERED IN THE MARKING METHOD FOR EXAMINATION OF GROWTH AND AGE OF WHALES

On the whale marking investigations many reports have been published. However, most of them are on the migration and movements. And the reports on the examination on the age and growth by means of whale marking are relatively few, and all of them are fragmentary. Mackintosh (1942) discussed the rate of accumulation of corpora albicantia in the ovaries on a recaptured fin whale. Omura & Kawakami (1956) studied the growth of the marked sperm whales. Ohsumi, Nishiwaki & Hibiya (1958) discussed the growth and age of the fin whale in the northern Pacific from the data of whales recaptured by Japanese whalers. Chittleborough (1959) used results of marking for the study of age in the humpback whale (*Megaptera novaeangliae*). Dawbin (1959) also studies whale marking as the evidence on growth rate of the humpback whales. Laws (1961) examined the annual corpora accumulation rate from 10 recaptured fin whales.

In the whales, it is entirely difficult to use the similar marking method as is usually used in other animals liked as fishes or birds. That is to say, in the whales except some porpoises and dolphins, we cannot catch and examine biologically the individual on board of ship before the marking and discharge. Therefore, one of the weak points in the whale marking is the difficulty of the biological investigation at the time of marking. Although it is not so weak point for the purpose to examine the movement of whales, it is the biggest defect to the study of the growth and age of the whales.

We usually estimate the species and body length of the whale at marking. At that time, the estimation involves more or less errors, because we measure with eye the whales moving in the water. Sometimes we make mistakes in estimation of species. For example, a Japanese mark No. 4267 whales was recorded as a sei whale (*Balaenoptera borealis*) at the marking, but it proved to be a fin whale in the recovery. It is difficult to distinguish between a sei whale and a Bryde's whale

(*B. edeni*) at the time of marking, therefore, Bryde's whales were recorded as sei whales in the marking records of our country. The mistake of this sort affects to the calculation of population size by means of the marking method. It is also difficult to estimate the sexes of the whale at marking, except adult killer whale or some other species. Furthermore, we cannot estimate the age of a whale at marking. When a calf with its mother is marked, we can estimate its approximate age. But in other cases, we cannot estimate the age and collect the age characters of a whale at marking. Whale mark is only used as a correct artificial age character from marking till recovery.

The next point is the scantiness of the marked and recovered whales. For the purpose of the study of growth and age of whales by means of marking, the more recovered whales we get, the better results are obtained. But, at first, we cannot use many marks, for the marking investigation is very expensive. On the second, the rate of hit on whales is relatively low. On the third, the rate of recovered whales per marked whales is also relatively low.

The third point to be considered in the marking method for the study of growth and age of the whale is the influences to the whale body by the marking. Whale marking which we use is not what is called a marking but a sort of tagging, and a 25-28 cm long metal tube is inserted in the body of whales. The body parts of the insertion is mainly the muscle of back, but sometimes the mark destinates the vertebrae or internal organ. Therefore, sometimes abnormality must be considered in the growth and life of whales by marking. The example that 3 sperm whales which had been marked in the adjacent waters to Japan were found floating dead shortly later shows a fatal influence of marking to those whales (Omura & Kawakami, 1956). The marks were inserted in the body cavity of those whales. There are other some examples in which the marks influenced badly on the growth of whales.

The fourth point is the difficulty of investigation of recovered whales. The best condition to investigate the marked whale is to discover the mark before the flensing and for that purpose streamer mark was made to try (Ruud, Clarke & Jongsard, 1953; Omura & Kawakami, 1956), and a modified mark was tested by Chittleborough & Godfrey (1957), because the earlier the mark is discovered in flensing, the better investigation is made on the recovered whales. When the mark is recovered in flensing, meat cutting or bone cutting, the mark is usually checked with the marked whale and we can investigate and collect the necessary data and material for the examination of the age and growth. But if a mark is recovered in cooker or reflegarator vessel, we cannot connect the mark with the marked whale. Fortunatley, in Japanese fleets, we flense the whales thoroughly, because we use the whale for food, and we can recover many marks in the place outside of the cooker.

Marking is considered to be an artificial age character, and although marking has a weak point that we cannot know the age of the whale before the time of marking, it has an advantage that we can confirm the elapsed time from marking until recapture.

If an age character increase in arithmetical progression, age at the time of marking is symbolized as x , elapsed time as t , and the annual accumulation rate is b , the size of age character at the time of recapture (y) is:

$$y = b(x+t)$$

Then,

$$\frac{y}{t} = b\left(\frac{x}{t} + 1\right)$$

The smaller x is, and the larger t becomes, the smaller x/t becomes. Then, y/t becomes near b . Therefore, the useful material for estimation of the accumulation rate of age character by means of marking is desirable to be long elapsed time and younger age until the time of marking.

EAR-PLUG LAMINATIONS OF RECAPTURED WHALES

Tables 1 and 2 show the number of ear-plug laminations, elapsed years and number of laminations dividing by the elapsed years for 59 fin whales recaptured by Japanese fleet in the Antarctic and the northern part of the North Pacific, which are listed in the paper of Ohsumi (1962).

If a whale mark fit a new-born whale, we can get an actually annual accumulation rate of ear-plug laminations, but this case is practically impossible. All whales will be marked at some time after birth. And if we can record the time of marking in an ear plug, we shall get an accurate number of laminations per year by counting the number of lamination from the record, but such recording is now also impossible.

Then, as the laminations accumulated in the time from marking until recovery are added to the laminations which were accumulated by the time of marking, the mean values which are got dividing the total number of ear-plug laminations by the elapsed time come to be more than the actually annual number of laminations.

The longer the elapsed time is, the shorter relatively is the time from birth until marking. Therefore, the mean number of laminations per year approaches to the actually annual increment of laminations as the period from marking until recovery increases.

Fig. 1 shows the relation between the elapsed time and the mean number of ear-plug laminations, and in addition shows the typical curves of mean number of ear-plug laminations for the case of 4 whales which are, respectively, just born (D, D'), 10 laminations (C, C'), 25 laminations (B, B') and 50 laminations (A, A') at the time when they are marked. Broken lines (A', B', C', D') show the case in which the annual increment of ear plug is 2 laminations, and solid lines (A, B, C and C) show the case in which the annual increment is one lamination.

In the whales which were recovered within one year, the apparent mean numbers of laminations per year are relatively large. But in those which were recovered after more than 2 years, we get relatively smaller figures.

There is a North Pacific fin whale (No. J. 6817) of which mean number of

TABLE 1. DATA FOR EXAMINATION OF ACCUMULATION RATE OF EAR-PLUG LAMINATION BY RECAPTURED FIN WHALES IN THE ANTARCTIC (DISCOVERY MARKS)

Mark No.	Sex	Elapsed time (A) (Yr.-Mon.)	Estimated body length at marking (ft.)	Body length at recapture (ft.)	No. of ear-plug laminations (B)	B/A
17860	M	0-2	59	57	7	—
22236	M	0-1	66-67	60	8	—
22417	F	0-0	65	66	18	—
22517	F	0-1	70	73	22	—
22526'30'33	M	0-1	67	69	31	—
24038	M	0-1	60	63	10	—
24083	M	0-1	70	64	8	—
24202	M	0-0	70	65	10	—
24361	M	0-1/2	62	66	16	—
24501	F	0-0	66	68	24	—
22517	M	0-2	66-65	62	6	—
24064	F	0-2	70	70	16	—
24349	F	0-2	55	62	7	—
24547	M	0-3	70	70	53	—
17876	M	1-1	58	63	24	22.2
17476	M	1-2	63	67	16	13.7
17903	F	1-1	70	69	10	9.23
19813	M	1-1	74	69	15	13.8
20944	F	1-1	65	75	60	55.4
21077'90	F	1-1	67	74	22	20.3
21161'72	F	1-1	54	71	19	17.5
20927'8	F	1-2	65	64	6	5.15
13347	M	2-4	—	64	8	3.44
19811	M	2-2	65	63	9	4.15
21081'5	M	2-1	63	66	15	7.20
21190	M	2-1	68	62	9+(3)	5.76
17516	F	3-1	64	72	18	5.84
14610	M	3-1	64	66	21	6.81
17894	F	3-2	75	67	21	6.63
17945	M	3-1	70	67	14+(2)	5.17
18049	M	3-2	66	65	57	18.0
18330	M	3-1/2	67	67	12	3.96
18573	F	3-3	62	68	24	7.38
16309	F	4-0	66	73	42	10.5
14700	F	4-1	68	77	29	7.11
12761	M	4-2	62	67	14	3.36
14779	F	4-3	63	73	67+	15.8+
14621	F	5-2	65	69	15+(2)	3.29
12798	F	5-4	68	73	48	9.00
12677	F	6-4	70-75	72	31	4.90
3013	F	24-11	—	70	33	1.33
3184	F	24-11	—	69	36	1.45
2825	F	25-0	—	71	38	1.52
2932	M	25-0	—	66	38+(3)	1.64
3171	F	25-0	—	72	28	1.12
5763	M	24-11 1/2	—	69	34	1.37

TABLE 2. DATA FOR EXAMINATION OF ACCUMULATION RATE OF
EAR-PLUG LAMINATION BY RECAPTURED FIN WHALES
IN THE NORTHERN PART OF THE NORTH PACIFIC
(JAPANESE MARKS)

Mark No.	Sex	Elapsed time (A) (Yr.-Mon.)	Estimated body length at marking (ft.)	Body length at recapture (ft.)	No. of ear-plug laminations (B)	B/A
7968	F	0-0	62	66	9	—
8416	F	0-0	62	57	4	—
8433	F	0-0	65	63	9	—
8434	M	0-0	53	61	6	—
8567	F	0-0	60	69	31	—
8618	M	0-0	63	61	19	—
8632	F	0-1/2	66	73	12	—
7988	M	0-0	64	59	6	—
6801'2	F	0-10	60	58	7	8.43
6799	M	0-10	60	59	13	15.7
7962	F	0-11	61	64	12	13.2
6834	M	0-9	69-70	61	28	37.3
6831'7	M	0-10	61-62	58	14	16.9
7975	M	1-0	64	61	50	50.0
7686	F	1-1	62	57	10	9.23
4552	F	1-10	60	62	11	6.01
6264	M	1-10	60	56	8	4.37
6807	F	1-10	56-57	57	5	2.73
6939	F	1-11	62	64	41	21.5
7708	F	1-11	55-57	62	8	4.19
6923	F	2-0	62	64	32	6.00
5979	M	2-0	60	58	9	4.50
8089	F	2-1	73	68	13	6.25
6808	F	2-9	65-66	64	15	5.45
4558	M	2-10	65	62	21	7.42
7026	M	2-10	60	62	14	4.95
7200	M	2-10	54	58	8	2.83
6274	F	2-10	60	62	8	2.83
6835	M	2-10	60-61	61	16	5.65
7170	M	2-11	55	59	9+	3.08+
6504	F	2-11	63	58	7	2.40
6782'5	F	2-11	60	61	8	2.74
3243	F	3-0	(70)	55	13	4.33
6471'7'8'80	F	3-0	54-55	57	12	4.00
6498	M	3-0	61	60	12	4.00
7705	F	3-0	66-68	60	13	4.33
7727	F	3-0	58	65	19	6.33
7737	M	3-1	60	64	10	3.25
7541	F	3-1	60	58	6	1.95
6817	M	3-10	57	59	6	1.57
6977	M	3-10	55	61	12	3.13
3391	M	3-11	63	64	27	6.89
6044	F	4-10	65	67	21	4.35
7025	M	4-10	55	63	13	2.69
4393	F	4-11	60	65	21	4.27
6052	F	4-11	62	67	9+	1.83+
6098	M	4-11	52	62	9	1.83
4615	M	4-10	—	61	12	2.48
4452	M	5-0	—	59	10	2.00
6172	F	5-1	56	62	11	2.16
4564	F	5-9	60	56	10	1.74
6097	M	5-9	62	65	23	4.00
5960	M	5-11 1/2	50	64	15	2.52
4146	F	6-0	60	68	16	2.67
3287'3343	M	6-11	65	64	16	2.31
4651	M	6-11	65	67	43	6.22

laminations per year is 1.6, although it was recovered only 3 years and 10 months later. According to the record at marking, the whale was estimated as 57 feet long, and it might be over one year old at marking. When the age at marking is added on the elapsed time, mean number of laminations per year becomes under 1.3.

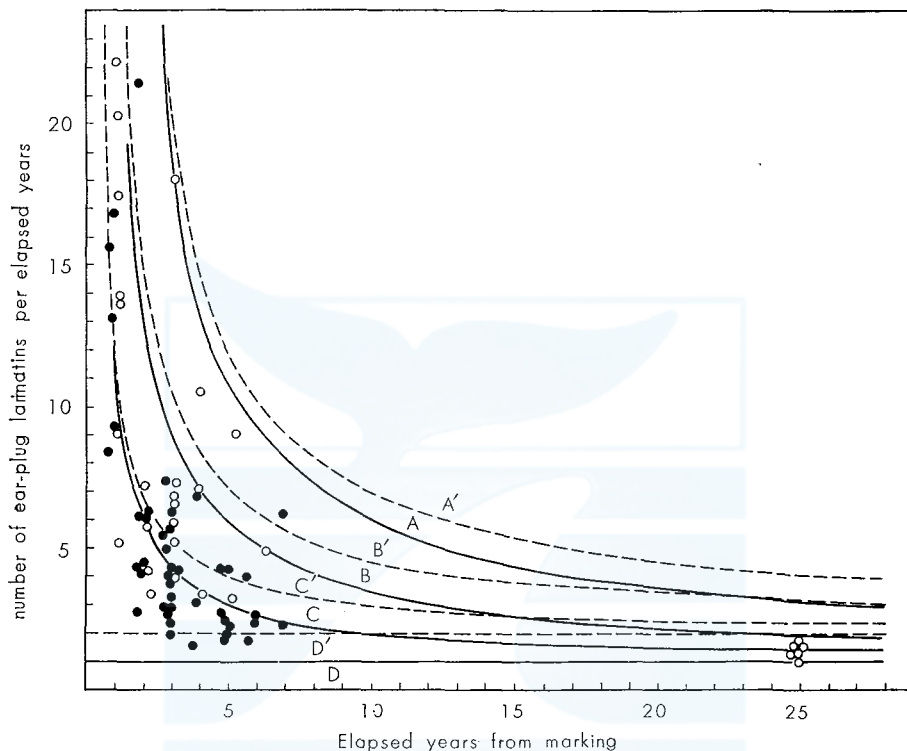

Fig. 1. Change of number of ear-plug laminations per elapsed years according to the elapsed years from marking until recapture.

A, A': 50 laminations at marking, B, B': 25 laminations at marking, C, C': 10 laminations at marking, D, D': 0 lamination at marking (birth at marking), A, B, C, D: One lamination accumulate a year, A', B', C', D': Two laminations accumulate a year. Open circle: Antarctic fin whale, closed circle: North Pacific fin whale.

In the North Pacific, Nos. J. 7541, J. 6098 and J. 4564 whales are also calculated the mean number of laminations per elapsed years as under 2, notwithstanding their elapsed times are within 6 years. Further, in the Antarctic, 6 long term marked fin whales from which ear plug were collected had been recaptured by Japanese fleets by 1961/62 season. The mean numbers of laminations per elapsed year of the 6 whales are all under 2 (1.33 in No. E. 3013, 1.45 in No. E. 3184, 1.52 in No. E. 2825, 1.64 in No. E. 2932, 1.12 in No. E. 3171, and 1.37 in No. E. 5763). The tip of ear-plug core of No. E. 2932 whale is broken, but the broken laminae layers are estimated to be less than three, and the total lamination are

estimated to be 41.

There is no whale of which mean number of ear-plug lamination is calculated as under 1.0 per year.

The mean number of ear-plug laminations per year calculated in this way, should be more than 2 for all recaptured whales, if they are actually laid down biannually. However, in view of these examples, the annual increment of ear-plug laminations is estimated to be under 2 for the marked fin whales, perhaps near one lamination per year. The solid lines in this examination also support the estimation that the accumulation rate of ear-plug lamination must be under two annually, and may be near one per year.

TABLE 3. ESTIMATION AND COMPARISON OF THE AGE COMPOSITION OF RECAPTURED FIN WHALES AT MARKING BETWEEN TWO CASES OF ANNUAL ACCUMULATION RATE OF EAR-PLUG LAMINATION

Annual accumulation rate of ear plug	Age at marking	Elapsed years (actual figures)					Elapsed years (per cent)			
		0	1-2	3-4	5-7	Total	0	1-2	3-4	5-7
One	51<	1	1	2	—	4	4.6	3.7	6.9	0.0
	26-50	2	4	2	3	11	9.1	14.8	6.9	18.8
	11-25	7	10	12	4	33	31.8	37.0	41.4	25.0
	6-10	11	10	7	6	34	50.0	37.0	24.2	37.5
	0-5	1	2	6	3	12	4.6	7.5	20.7	18.8
	0>	—	—	—	—	—	0.0	0.0	0.0	0.0
	Total		22	27	29	16	94			
Two	51<	1	1	2	—	4	4.6	3.7	6.9	0.0
	26-50	2	4	1	2	9	9.1	14.8	3.4	12.5
	11-25	7	8	8	4	27	31.8	29.6	27.6	25.0
	6-10	11	8	9	1	29	50.0	29.6	31.1	6.3
	0-5	1	6	7	7	21	4.6	22.2	24.2	43.8
	0>	—	—	2	2	4	0.0	0.0	6.9	12.5
	Total		22	27	29	16	94			

Table 3 and Fig. 2 show the estimated age composition at the time of marking by recaptured fin whales. Estimated age at marking is calculated from number of lamination at recapture, elapsed time and the annual accumulation rate of ear-plug laminations. I calculated the estimated age in two cases where annual accumulation is one and two. The comparison of age composition at marking is made in elapsed year classes 0, 1-2, 3-4 and 5-7. According to Fujino (1960), the estimated size distribution of marked whale at the time of marking is not so different from that which were caught, although young whales distribute little rather more than the whales caught and the markings of whales are considered to be made at random from the stock in the whaling ground. If so, the estimated age distribution at the time of marking must be not so different in each season. Now, as shown in Fig. 2, the age composition at the time of marking is not so changed according to the elapsed years for the case of one-lamination age. Ratio of the age class of 0 to 5 at the time of marking increases according to the elapsed years. This can

be explained that small whales are not caught soon after marking, but they grow to captuable size as the time goes by. On the contrary, in the case of two-laminations age, estimated age composition of marked whale at the time of marking changes by the increment of elapsed years. And in 5 to 7 elapsed years classes, the composition of under 5 years old class exceeded the half of total whales. This is not able to be explained, because the age distribution of marked whales must not be so different from the whales caught at the time of marking. Besides, there exist the whales under 0-year old at the time of marking in the case of two-laminations age. They must be marked before birth. This is not practical.

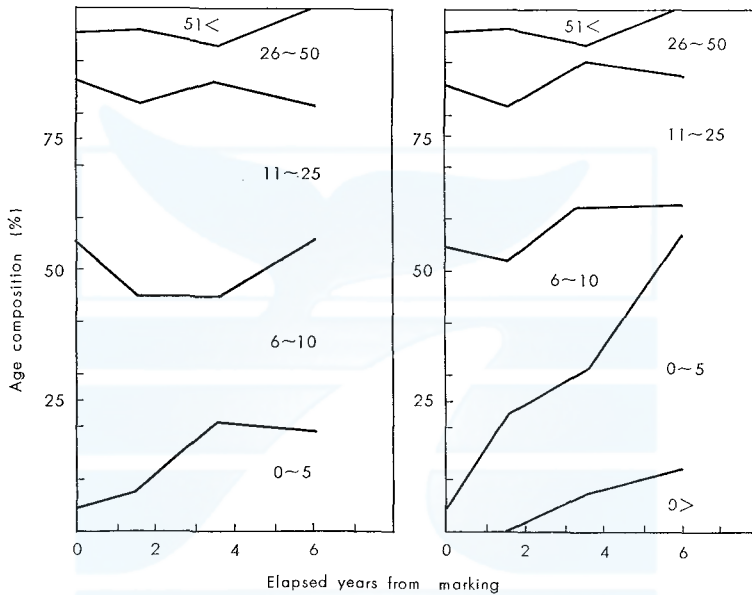

Fig. 2. Change of estimated age composition of recaptured fin whale at the time of marking according to the elapsed years from marking. Left figure: Annual rate of ear-plug accumulation is one lamina, Right figure: Annual rate is two laminae.

However, Chittleborough (1959) reported that a male humpback whale was marked when its body length was approximately 30 feet (he estimated to be a yearling) and it was recaptured 4 years and 10 $\frac{2}{3}$ months later. The ear plug contained as 12 laminations. From the above result, he agreed with the biannual formation of ear-plug lamination. I am afraid that the whale was truly yearling. The estimate body length is sometimes different with the actual length. And there is individual variation in the body length. Dawbin (1959) also reports a marked humpback whales which had been at least one year old at marking and was recaptured 19 months later. Examining its baleen plate and ear plug, he states that the result are consistent with the view that ear plugs develop two laminations per year.

EXAMINATION OF THE AGE AT SEXUAL MATURITY
BY THE MARKED WHALES

Sexual maturity is one of the remarkable stages in the life history of whales. Besides, it is used for classification of broad age groups. Therefore, it is considered to be a kind of age character. On the age at sexual maturity of the fin whale, Mackintosh & Wheeler (1929) state that an examination of sizes of young whales at different times of year suggests that sexual maturity is reached about 2 years after birth. Studying the baleen plates, Ruud (1945) describes that it is apparent that majority of the northern fin whales attain sexual maturity at an age of 3 years. From the similar method, Nishiwaki (1952) states that females reach to sexual maturity in the pairing season following the fourth birth day and the males at the age of about 3 years and a half in the case of the southern fin whales. In the modified method of surveying baleen plates, Van Utrecht (1956) obtained a result that the age at which the female becomes sexually mature lies between 5 and 6 years.

TABLE 4. SEXUALLY MATURE AND IMMATURE FIN WHALES IN
EACH ELAPSED YEARS FROM MARKING UNTIL RECAPTURE
(INCLUDED DATA FROM TABLE BY LAWS, 1961)

		Elapsed years from marking															Total		
		0	1	2	3	4	5	6	7	11	12	17	19	20	21	23		24	25
Males	I	8	4	2	1	1	3	—	—	—	—	—	—	—	—	—	—	—	19
	S	7	2	—	3	1	2	—	—	—	—	—	—	—	—	—	—	—	15
	M	8	8	3	5	2	1	2	2	—	—	—	—	—	—	—	—	1	32
Females	I	8	8	2	5	—	1	1	—	—	—	—	—	—	—	—	—	—	25
	S	5	4	1	4	—	1	1	—	—	—	—	—	—	—	—	—	—	16
	M	13	6	8	6	3	5	4	—	1	1	1	1	1	1	1	1	4	57
M+F	I	16	12	4	6	1	4	1	—	—	—	—	—	—	—	—	—	—	44
	S	12	6	1	7	1	3	1	—	—	—	—	—	—	—	—	—	—	31
	M	21	14	11	11	5	6	6	2	—	—	—	—	—	—	—	—	—	90
Total		49	32	16	24	7	13	8	2	1	1	1	1	1	1	1	1	5	164

Remarks: I: Sexually immature (under 2.4 kg in larger testis for male, 0 ovulation for female).
S: Soon after sexual maturity (2.5–5.0 kg in testis for male, 1–2 ovulations for females).
M: Sexually mature (over 5.1 kg in testis for male, over 3 ovulations for females).

Since the discovery of laminations in ear plug, Laws & Purves (1956) reported that sexual maturity was reached at the age from 4 to 6 years in the male from the North Atlantic. Nishiwaki (1957) learned in the same method the age of sexual maturity of the southern fin whale was 4 or 5 years. Ohsumi, Nishiwaki & Hibiya (1958) state that if two laminations are formed every year, the fin whale in the northern Pacific will attain at sexual maturity in early term of seventh year after birth, and the precocious will be mature sexually by the fifth year, furthermore, by the eighth year all the fin whales will attain at sexual maturity. Purves & Mountford (1959) give a figure of 4 and a half years for males and 5–6 years for females. Laws (1961) also shows the percentage frequency of sexually mature females in different age-groups from ear plug (biannual rate), and get that the age corresponding to 50% of mature females is about 5 years.

Above results are not lead with the absolute age of whales. Table 4 shows the number of animals which are determined their sexual maturity among the recaptured fin whales. Data used for this purpose are from Ohsumi (1962) and Laws (1961). I divided sexually mature whales into two groups, that is, soon after maturity and fully mature groups.

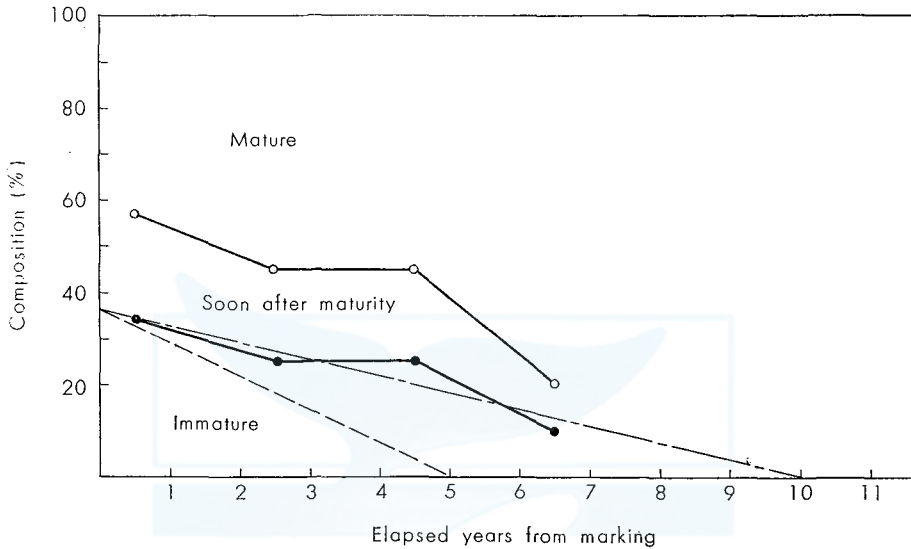

Fig. 3. Change of composition of sexually mature and immature fin whales recaptured according to elapsed years, and estimation of age at sexual maturity. Chain line: Regression line of immature rate, Broken line: Estimated decreasing line of immature rate assuming the age at sexual maturity as 5 years.

And Fig. 3 shows the change of the composition of sexually immature and mature animals according to the elapsed years calculated from Table 4. In 0-year group which were recovered within 3 months later, the rate of sexually immature whales is 32.7%. This is almost the same ratio as the usually caught whales in the factory ship whaling. But as the time elapses, the rate of immature whales gradually decreases. There is a sexually immature female whale (J. 4564) which was recovered 5 years and 9 months later. This whale certifies the existence of an individual which is sexually immature in the age of at least 5 years and 9 months. This whale had been estimated to be 60 foot long at the time of marking. Considering the error of the estimation, the whale is thought to be at least 1 or 2 years old at that time. If so, this whale must be still sexually immature in the age of 7 or 8 years.

There were several recovered whales which are estimated to be soon after sexual maturity more than 3 years later from marking. One of them is a female recovered 3 years later (J. 3243). It has only one corpus albicans in the ovaries. Considering from the existence of vaginal band and immature mammary gland, this whale is assumed to be soon after sexual maturity (puberty as defined by Chittle-

borough, 1954).

Regression line is calculated from the elapsed time and the composition equation of immature whales. It is:

$$Y = -3.68X + 36.49$$

Where, Y is a percentage of immature whales, and X is the elapsed years. From this equation, following values are calculated: The percentage of immature whales is 36.49 at the time of marking ($X=0$), and the elapsed time is 9.93 years when percentage of immature whale is 0.

Thus, we can estimate that the age at sexual maturity is about 10 years from the examination of age at sexual maturity by the recaptured fin whales. Broken line in Fig. 3 is a estimated declining line of sexually immature ratio, when the age at sexual maturity is considered to be 5 years as many authors reported. This broken line does not fit the actual change of composition of sexually immature animals. We must consider that there is individual variation in the age at sexual maturity, but usually whales are marked somewhile later from birth. And there are 5 immature animals (25%) among 20 animals which were recaptured after 4 and 5 years from marking. Even among 10 recaptured animals after 6 and 7 years' elaption from marking, there is one immature animal (10%). This phenomenon may mean that the age at sexual maturity is longer in fin whale than those which are recognized today by us, and I estimate from the change of composition of sexually immature animals according to elapsed years that the age at sexual maturity is about 10 years.

On the humpback whale, Chittleborough (1959 b) reported an sexually immature male which was recaptured 4 years and 1 month later.

ANNUAL ACCUMULATION RATE OF CORPORA ALBICANTIA IN THE RECAPTURED FIN WHALES

Chittleborough (1959 a) reportes "One female humpback whale marked when it was accompanied by a calf was killed 9 years later. The ovaries then obtained 10 corpora albicantia, so that if this female had been marked at the end of its first pregnancy, the average rate of ovulation would have been 1.0 ovulations per year." And calculating from the data by Chittleborough (1959 b), a mean number of ovulations per year for a marked humpback whale recovered 17 and a half years later is 0.9 ovulations.

By a result of a fin whale recovered 6 years and 2 months later, Mackintosh (1942) states that one cannot draw any final conclusion, but in this one, since it had only 8 corpora lutea, the rate of accumulation (mean number of ovulations is 1.3 per year) cannot have been much more than about one a year, and since there was no clue to the whales age at the marking, the rate of accumulation may have been even slower.

Laws (1961) checked the corpora accumulation rate by 10 recaptured fin whales. He calculated the mean elapsed period as 13.8 years (ranging from 2 to 24 years) and the mean corpora as 15.7 (ranging from 3 to 40). Then he gets the

TABLE 5. DATA FOR EXAMINATION OF ANNUAL ACCUMULATION RATE OF CORPORA ALBICANTIA IN THE MARKED FIN WHALES CAUGHT IN THE ANTARCTIC (DISCOVERY MARKS)

Mark No.	Elapsed time (Year-Month)	Estimated body length at marking (ft.)	Body length at recapture (ft.)	No. of corpora	No. of corpora per elapsed year
24350	0-0	61	63	0	—
18087	0-1	66	73	12	—
21196'98	0-1	70	64	4	—
14576	0-2	60	69	3	—
19843	0-2	66	64	0	—
20502'4	0-2	62	66	1	—
21187'21200	0-2	70	73	19	—
24064	0-2	70	70	18	—
24349	0-2	55	62	0	—
19837'9	0-3	66	64	0	—
20735	0-3	67	66	0	—
17903	1-1	70	69	1	0.92
19746	1-1	60	65	0	0.00
19835	1-1	63	69	2	1.85
19840	1-1	67	69	6	5.53
20927'8	1-2	65	64	0	0.00
15388	1-2	—	65	2	1.72
17839	1-2	62	66	0	0.00
17457	2-1	65	71	6	2.88
17516	3-1	64	72	3	0.97
18073	3-3	62	68	2	0.60
19921	3-2	60	63	0	0.00
13278	5-2	68	73	15	2.90
13481	6-2	60-65	73	13	2.11
6472	20-1	—	71	9	0.45
3507	20-11	—	70	23	1.10
3103	24-11	—	70	15	0.60
2627	24-1	—	69	32	1.33
5594	22-11	—	74	12	0.53
*10504	2.23	—	71	10	4.48
*12870	3.23	—	70	3	0.93
* 696	6.21	—	76	8	1.29
* 7972	11.13	—	69	5	0.45
* 4938	12.06	—	73	14	1.16
* 6818	17.05	—	75	40	2.33
* 1199'1203 } * 1300 }	19.12	—	76	11	0.58

* Cited from Table 30 by Laws (1961)

TABLE 6. DATA FOR EXAMINATION OF ANNUAL ACCUMULATION RATE OF CORPORA ALBICANTIA IN THE MARKED FIN WHALES CAUGHT IN THE NORTHERN PART OF THE NORTH PACIFIC (JAPANESE MARKS)

Mark No.	Elapsed time (Year-Month)	Estimated body length at marking (ft.)	Body length at recapture (ft.)	No. of corpora	No. of corpora per elapsed year
4266	0-0	68	62	1	—
7968	0-0	62	66	1	—
8416	0-0	62	57	0	—
8433	0-0	65	63	0	—
8632	0-1/2	66	73	4	—
4684	0-1	65	61	2	—
4802	0-1	71	65	1	—
7720	0-1	64-66	66	7	—
8567	0-0	60	69	11	—
4270	0-2	68	63	0	—
4658	0-11	61	58	0	0.00
4543	0-11	62	66	9	9.81
6815	0-10	62	60	0	0.00
6843	0-10	62-63	56	0	0.00
6801'2	0-10	60	58	7	8.08
7962	0-11	61	64	2	2.18
4552	1-10	60	62	1	0.55
6042	1-8	55	64	9	5.40
5995	1-10	57	65	15	8.27
6939	1-11	62	64	14	7.30
7708	1-11	55-57	62	0	0.00
6807	1-10	56-57	57	0	0.00
7686	1-1	62	57	0	0.00
4267	2-0	45	63	3	1.50
6923	2-0	62	64	8	4.00
6274	2-10	60	62	1	0.35
6504	2-11	63	58	0	0.00
6782'5	2-11	60	61	0	0.00
6808	2-9	65-66	64	6	2.18
8089	2-1	73	68	3	1.44
3243	3-0	(70)	55	1	0.33
3213	3-2	60	63	16	5.06
6471'7'8'80	3-0	54-55	57	0	0.00
7705	3-0	66-68	60	3	1.00
7270	3-2	60	60	1	0.32
7727	3-0	58	65	4	1.33
7541	3-1	60	58	0	0.00
4393	4-11	60	65	5	1.02
6044	4-10	65	67	7	1.45
6052	4-11	62	67	2	0.41
6172	5-1	56	62	0	0.00
4564	5-9	60	56	0	0.00
4146	6-0	60	68	1	0.17

result that mean increment of corpora is likely to be 1.14 per year if fin whales are marked on average at about the time of puberty.

Table 5 and 6 show data for examination of corpora accumulation rate by recaptured fin whales. Most of data are obtained by Japanese fleets in the Antarctic and the northern part of the North Pacific which are listed in the paper of Ohsumi (1962). In addition to them, I cited the data from Table 30 of the paper by Laws (1961).

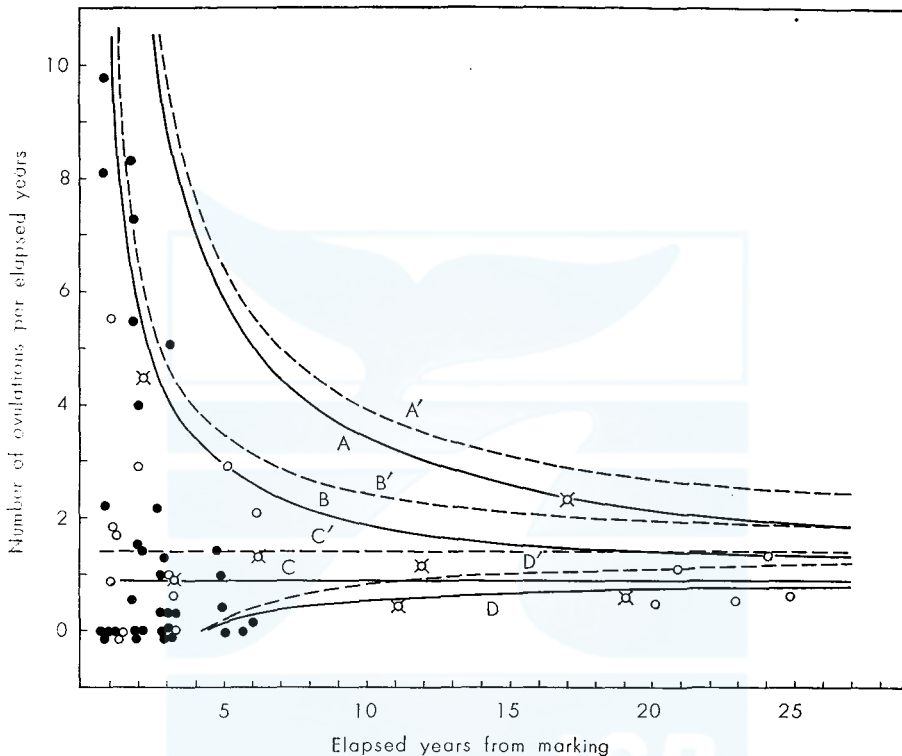

Fig. 4. Change of number of ovulations per elapsed year according to the elapsed years from marking until recapture. A, A': 25 ovulations at marking, B, B': 10 ovulations at marking, C, C': Just sexually mature at marking, D, D': Just birth at marking, A, B, C, D: Age at sexual maturity is 5 years, and 0.9 ovulations per year (Nishiwaki et al., 1958), A', B', C', D': Age at sexual maturity is 5 years, and 1.43 ovulations per year (Laws, 1961).

If the time of marking coincides with the attainment of sexual maturity of the marked whale, we can get the actual annual-increment of corpora albicantia, dividing the number of ovulations by the elapsed years. But it is a very rare case, and most whales will be marked after or before the time of sexual maturity. When a sexually mature whale is marked, the mean number of ovulations per year, given by dividing the number of ovulations at recovery by the elapsed years, is more than the actually annual number of ovulations. On the contrary, when a sexually im-

mature whale is marked, the mean number of ovulations per year should be less than true annual number of ovulations. However, as the elapsed time from marking increases, the number of ovulations accumulated before marking becomes relatively small, and mean number of ovulations calculated must approach to the actually annual rate of ovulations.

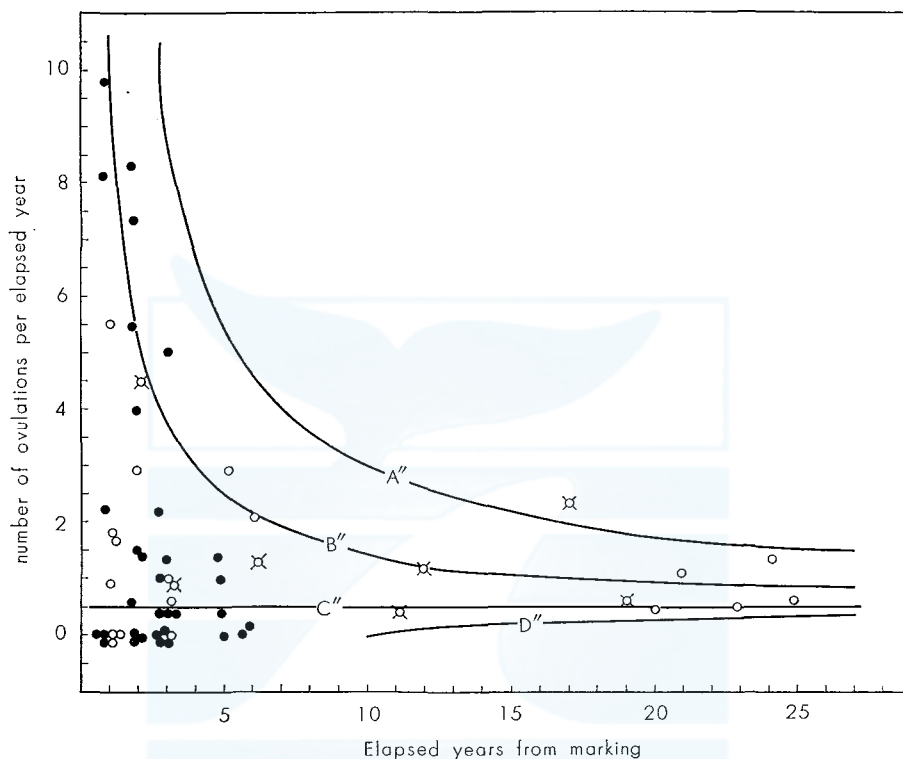

Fig. 5. Change of number of ovulations per elapsed year according to the elapsed years from marking until recapture. A'': 25 ovulations at marking, B'': 10 ovulations at marking, C'': Just sexual maturity at marking, D'': Just birth at marking. A'', B'', C'', D'': Age at sexual maturity is 10 years, and 0.5 ovulations per year.

Fig. 4 shows the relation between the elapsed years from marking till recapture and the mean number of ovulations per elapsed year. The range of the mean number of ovulations in marked whales which were recaptured shortly after, are largely distributed. The reason is that the number of ovulations before marking greatly influences the value obtained. However, with the lapse of time, the range becomes narrow, and more than 19 years later, mean annual number of ovulations in 6 Antarctic fin whales are within the limits of 0.45 and 1.33. The mean value of the 6 individuals is 0.77.

The broken line (A', B', C', D') in Fig. 4 is a case where the age at sexual maturity is 5 years and the annual accumulation rate of corpora is 1.43 as calculated by Laws (1961), and solid line (A, B, C, D) is another case where the age at sexual

maturity is 5 years and the annual rate of corpora is 0.9 as calculated by Nishiwaki et al. (1958) from the relation between the number of lamination in ear plug and the number of ovulation when annual accumulation of ear-plug lamination is assumed as two. A, B' ; B, B' ; C, C' and D, D' is the cases of 25 ovulations, 10 ovulations just puberty and just birth at the time of marking. According to this figure, broken lines do not fit the actual values, and there are 8 individuals which are under D' line. This means that the individuals had been marked before birth. This hypothesis is inconsistent with the actual data, for they must have been marked after birth. Solid lines are more suitable than the broken line, but they have the same inconsistency as broken line. Therefore, above two theories are not able to explain the actual figures obtained from recaptured fin whales.

TABLE 7. ESTIMATION AND COMPARISON OF OVULATION COMPOSITION OF RECAPTURED FIN WHALES AT MARKING BETWEEN TWO CASES OF ANNUAL RATE OF OVULATION

Annual rate of ovulation	Ovulation at marking.	Elapsed years (actual figures)						Elapsed years (per cent)				
		0	1-2	3-4	5-7	10-25	Total	0	1-2	3-4	5-7	10-25
0.50	26<	—	—	—	—	1	1	19.0	8.3	6.3	11.1	30.0
	11-25	4	2	1	1	2	10					
	6-10	1	6	—	1	2	10	42.9	50.0	43.7	44.4	40.0
	1-5	8	6	7	3	2	26					
	0	8	10	8	4	2	32	38.1	41.7	50.0	44.4	30.0
	Total	21	24	16	9	9	79					
1.43	26<	—	—	—	—	—	—	19.0	8.3	6.3	—	10.0
	11-25	4	2	1	—	1	8					
	6-10	1	4	—	1	—	6	42.9	37.5	6.3	22.2	0.0
	1-5	8	5	1	1	—	15					
	0	8	13	14	5	3	43	38.1	54.2	87.4	55.6	30.0
	Not birth	—	—	—	2	5	7	0.0	0.0	0.0	22.2	60.0
Total	21	24	16	9	9	79						

Fig. 5 shows the change of mean number of ovulations per elapsed year in the case where age at sexual maturity is 10 years as shown in previous section and the annual accumulation rate is 0.5 as discussed in the following chapter. According to this hypothesis, the curves (A'', B'', C'' and D'') fairly fit the actual values.

Age composition of marked whales is shortly less than the whales caught (Fujino, 1960). According to Laws (1961) and Mackintosh (1942), the average number of corpora of fin whale is calculated as 12.5 in adult female in 1939~41 season and the ratio of immature whales is 15.1% in 1936~37 Antarctic pelagic whaling. Therefore, the mean number of corpora including immature whales in 1936~40 season is calculated to be 10.6. If the mean number of corpora in ovaries of marked fin whales is 10 in the Antarctic pre-war seasons and the annual rate of corpora accumulation is assumed to be 0.5, mean corpora divided elapsed years after 20 to 25 years' elaption is calculated to be 1.0 to 0.9. This mean values agree relatively well with the mean number of corpora calculated from 6 recaptured fin whales

after 19~25 years elaption (0.77). If annual accumulation rate is 1.43, the former values must be comes between 1.93 and 1.83. This is larger than the actual values.

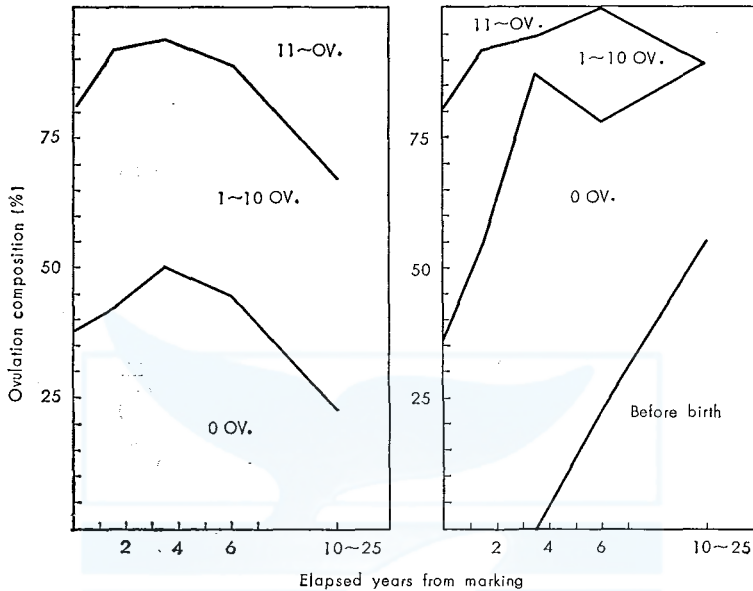

Fig. 6. Change of ovulations composition of recaptured fin whales at the time of marking according to the elapsed years from marking. Left: Annual rate of ovulation is 0.5 and the age at sexual maturity is 10 years, Right: Annual rate is 1.43 and age at sexual maturity is 5 years.

Now, Table 7 and Fig. 6 show the estimated corpora composition at the time of marking by recaptured fin whales. Estimated number of corpora at marking is calculated from number of corpora at recapture, elapsed time and the annual rate of corpora accumulation. And I calculated the estimated corpora number in two cases where annual accumulation rate is 0.5 and 1.43. The comparisons of corpora composition at marking is classified in elapsed year classes 0, 1-2, 3-4, 5-7 and 10-25. As repeatedly said, the estimated size distribution of marked whale is not so different from that which caught. If so, the estimated corpora distribution at the time of marking must be not so different in each season. According to Fig. 6, the estimated corpora composition is not so changed by 7 years of elaption from marking in the case of annual accumulation rate is 0.5. In the 10-25 elapsed years group, estimated immature whale is smaller than the former years classes. But this can be explained that they are pre-war marked whales, and in pre-war seasons the composition of larger whales must be larger than recent season. And the estimated composition of immature class of pre-war marked whale (22%) fairly agrees with the immature rate (15.1%) of pelagic catch in 1936-37 season obtained by Mackintosh (1942). On the contrary, in the case of which annual accumulation rate is 1.43, estimated

corpora composition at the time of marking changes remarkably by the increment of elapsed years. And over 4 elapsed years classes, the percentage of immature whales attains over 75%. This is not able to explain the actual age composition of the whales in the sea. Besides, there exist the whales before birth at the time of marking in the case of annual rate of 1.43, and the rate attains to 55% in 10-25 elapsed years class. This is not practical. Thus, this examination also support the estimation that the annual rate of corpora accumulation must be under 1.43, and may be near 0.5 per year.

However, above examination of annual rate of ovulations is considered as mean value. And we must remember that there are individual variations in the ovulation rate as shown by Nishiwaki et al. (1958), and racial variation as shown by Fujino (1963).

RELATION BETWEEN EAR-PLUG LAMINATION AND
OTHER AGE CHARACTERS
RELATION BETWEEN EAR-PLUG LAMINATION
AND NUMBER OF OVULATION

Fig. 7 shows the mean number of ovulations (corpora lutea and albicantia) in each class of ear-plug lamination for the fin whales caught in Antarctic Areas IV and V in 1958/59 and 1959/60 seasons.

As shown in this figure, there is linear relation between number of laminations and number of ovulations except the old age. An equation is given from this line. It is

$$Y = 0.49X - 4.28$$

Where, Y is the mean number of ovulations, and X is the number of ear-plug laminations. This equation is similar with that obtained by Nishiwaki, Ichihara & Ohsumi (1958).

Thus, coefficient of X is given as 0.49. If the accumulation rate of ear-plug lamination is one per year, the coefficient, that is, 0.49, shows the annual ovulation rate. Notwithstanding two ovulation rates are calculated independently by examination of ovulation of recaptured whales and by relation between number of ear-plug laminations and number of ovulations, the both agree closely with each other. This is, in other word, one of the certification that accumulation rate of ear-plug lamination is one per year.

SEXUAL MATURITY AND NUMBER OF EAR-PLUG LAMINATIONS

Fig. 8 shows the change of ratio of sexual maturity according to increment of ear-plug laminations for the Antarctic fin whales caught in Areas IV-V in 1958/59 and 1959/60 seasons. Individual stages of sexual maturity have been estimated from the standard described in previous chapter.

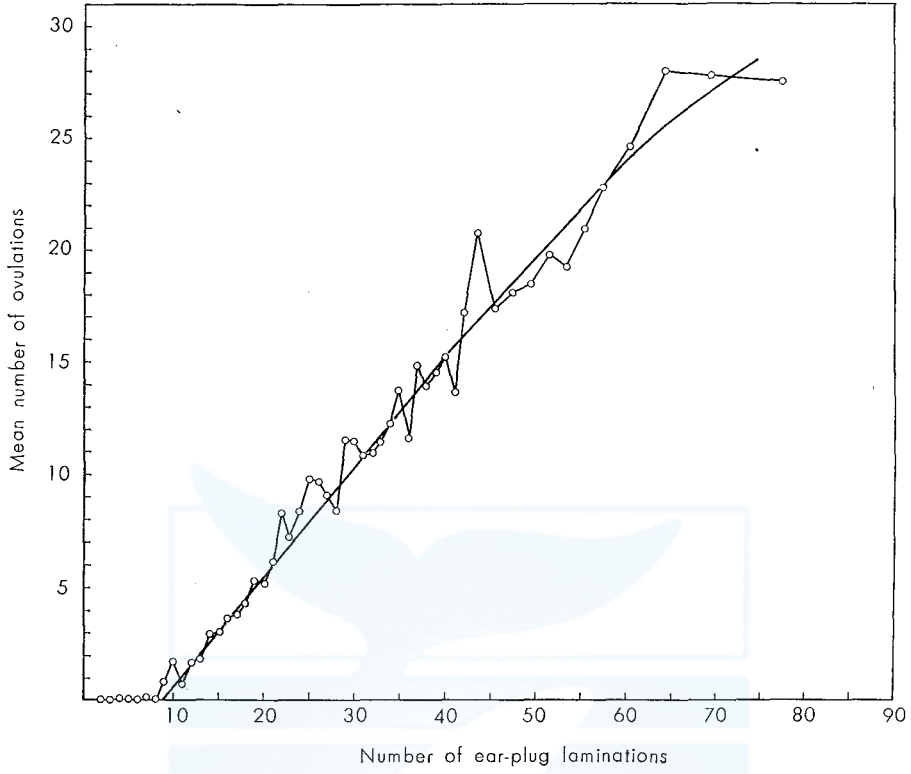

Fig. 7. Relation between number of ear-plug laminations and the number of ovulations in the Antarctic fin whale in Areas IV—V.

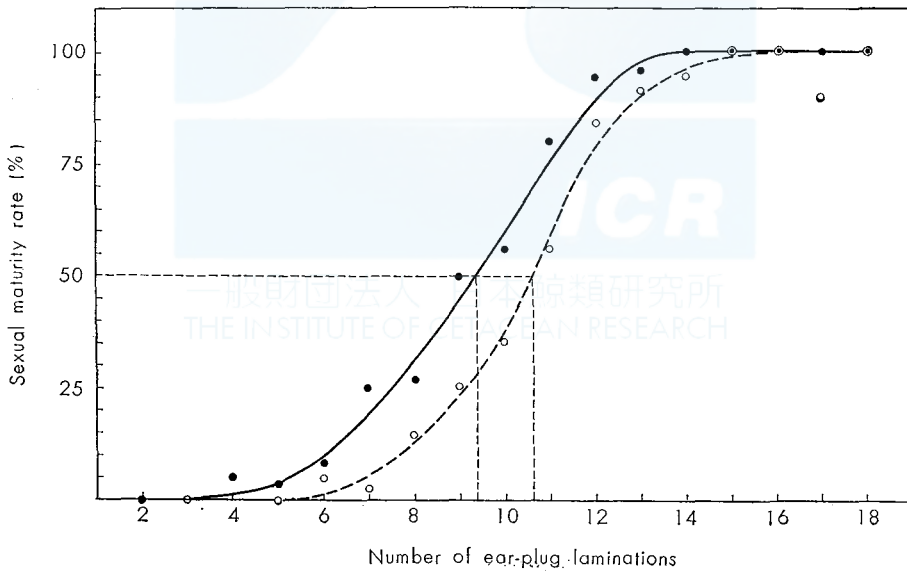

Fig. 8. Percentage of sexual maturity in successive ear-plug laminations, on the Antarctic fin whales in Areas IV—V. Open circles and broken line: Females, Closed circles and solid line: Males.

Males start to attainment of sexual maturity from 4 laminations, and by 14 laminations all individuals attain to maturity. Females attain to maturity later than the males, they start from 6 laminations and end by 15 laminations. The number of ear-plug laminations corresponding to 50% of maturity is 9.4 in males and 10.7 in females. In Fig. 7, the number of laminations at the point where one corpus level accross the average line is 11 laminations.

On the relation between number of ear-plug laminations and sexual maturity of fin whales, Laws & Purves (1956) compared testes weights and ear-plug laminations, and they concluded that sexual maturity is attained at 8–12 laminations in the case of males in the North Atlantic fin whales. Nishiwaki (1957) compared the number of laminations with number of corpora in ovaries of 34 Antarctic fin whales and he found that 10 laminations corresponded to one corpus. Nishiwaki, Ichihara & Ohsumi (1958) tabulated the frequency of sexually immature and mature fin whales caught in the Antarctic and North Pacific in different number of ear-plug laminations in Appendix. And they said that male and female fin whales matured at about 11 laminations. Purves & Mountford (1959) draw growth curves of males and females in the Antarctic areas I and II where ages are based on ear-plug laminations, and estimating body lengths at sexual maturity as 66 feet in females and 63 feet in males, they concluded that the age at sexual maturity is 10–12 laminations in the females and 9 laminations in the males. Laws (1961) shows the percentage of sexually mature females in successive age groups based on ear-plug laminations, and he obtains that age corresponding to 50% of mature female is about 5 years (10 laminations).

Summarizing the above results, the number of ear-plug laminations at sexual maturity may be concluded to be 10–11 in the females and 9–10 in the males respectively in the case of fin whales.

Now, in the examination of age at sexual maturity by recaptured fin whales, it is estimated to be about 10 years. This result is based on absolute time as elapsed years from marking until recapture. On the other hand, the number of laminations at sexual maturity is obtained independently as 9–11 laminae. Connecting these two results, I can get a conclusion that the annual accumulation rate of ear-plug laminations must be near one. This conclusion also coincides with the results obtained by the examination of annual rate of ear-plug laminations from recaptured fin whales.

RELATION BETWEEN EAR-PLUG LAMINATIONS AND RIDGES ON BALEEN PLATE

On the relation between number of ear-plug laminations and the number of ridges on baleen plates of fin whales, Laws & Purves (1956), Nishiwaki (1957) and Laws (1961) examined, and Chittleborough (1959) also examined the relation between ear plug and baleen on the humpback whale. They all recognized that two laminations corresponded to one ridge. However, for example, in Fig. 55 (p. 467) on the report by Laws, there are individuals which are over the 45° line. If two laminations correspond to one ridge, all individuals must be plotted on or right side of the

line. And in the Fig. 4 of the paper by Chittleborough (1959), also there are many individuals of which number of ridges more than half of the number of ear-plug laminations. And from these figures, we can consider that there is possibility of the existence of individual of which one ridge on baleen plate correspond to less than two laminations.

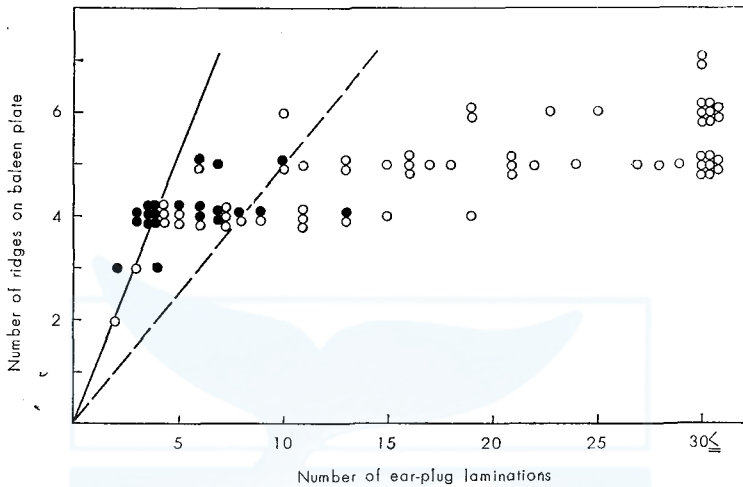

Fig. 9. Relation between number of ear-plug laminations and the number of ridges on baleen plate for fin whales. Open circle: Antarctic, Closed circle: North Pacific, Solid line: One lamina correspond to one ridge, Broken line: Two laminae correspond to one ridge.

Fig. 9 shows the relation between number of ear-plug laminations and baleen ridges on 53 Antarctic and 21 North Pacific fin whales. In this figure, broken line is based on hypothesis that two laminations correspond to one ridge, and solid line is based on another hypothesis that one lamination corresponds to one baleen ridge. As mentioned above, if former hypothesis is true, all individuals must be on the broken line or right side of the line, because baleen plate becomes to wear at the tip from relatively young ages (Ruud, 1950). However, there are many individuals which are on the left side of the broken line. Then, we must abandon the former hypothesis. On the contrary, almost of all points distribute on solid line or right side of the line. I have scanty data on the material less than 3 laminations, but the latter hypothesis approaches to the truth more than the former hypothesis. That is to say, there is possibility that one ear-plug lamination corresponds to one baleen ridge in the first few ages. As reviewed in Introduction, nowadays, it seems to be recognized that annual increment of baleen is equivalent to one ridge (Ruud, 1940, 1945; Nishiwaki, 1951; Chittleborough, 1959). If it is correct, one ear-plug lamination corresponds to one year. This conclusion agrees also with the results in former sections in the present paper. However, I must notice that there are 3 individuals which distribute on the left side of the solid line. Ichihara (1964) confirms the prenatal formation of ear plug. But there is no report on the forma-

tion of ear plug chiefly in calf stage. Further examinations are needed for this problem.

EXAMINATION OF AGE COMPOSITION BASED ON EAR-PLUG LAMINATIONS

AGE COMPOSITIONS OF FIN WHALES CAUGHT IN NORTH OF EAST ALEUTIAN ISLANDS

By immunologic and marking approaches, Fujino (1960) reported that almost of the fin whales caught in the north of east Aleutian Islands are composed with pure Population-II. And as Omura (1955) reported, the whaling in this area had not been operated on a large scale before the time when Japanese fleets began to operate in 1954.

TABLE 8. AGE COMPOSITION OF FEMALE FIN WHALES CAUGHT IN THE NORTH OF EAST ALEUTIAN ISLANDS DURING 1959 TO 1961

Age	Annual accumulation rate		Age	Annual accumulation rate	
	One lamination	Two laminations		One lamination	Two laminations
0	—	—	26	17	2
1	—	7	27	20	2
2	2	88	28	12	6
3	5	159	29	11	1
4	29	114	30	9	4
5	59	87	31	9	4
6	69	57	32	12	3
7	90	42	33	13	3
8	64	42	34	7	4
9	50	34	35	10	—
10	51	40	36	11	1
11	36	36	37	8	1
12	30	35	38	6	—
13	27	37	39	7	1
14	27	23	40	8	—
15	15	18	41	9	2
16	22	25	42	4	—
17	20	17	43	4	1
18	17	19	44	2	—
19	17	13	45	3	—
20	12	17	46	2	—
21	28	8	47	—	—
22	18	5	48	2	1
23	18	2	49	6	2
24	20	8	50	2	—
25	15	4	51<	43	3
			Total	978	978

Table 8 and Fig. 10 show the estimated age compositions of female fin whales caught in the north of east Aleutian Islands during 3 years from 1959 to 1961 based on ear-plug laminations. In this figure, the age distributions are converted on both

assumptions of biannual (two-laminations age ; broken line) and annual (one-lamination age ; solid line) accumulation rate of ear-plug laminations. Frequencies are shown in logarithm.

Modes of frequencies exist in 7 years in the case of one lamination age and in 3 years in the two-laminations age. This is because size limit is prescribed as 55 feet for northern hemisphere fin whale in the factory ship whaling, and younger animals are protected from whaling.

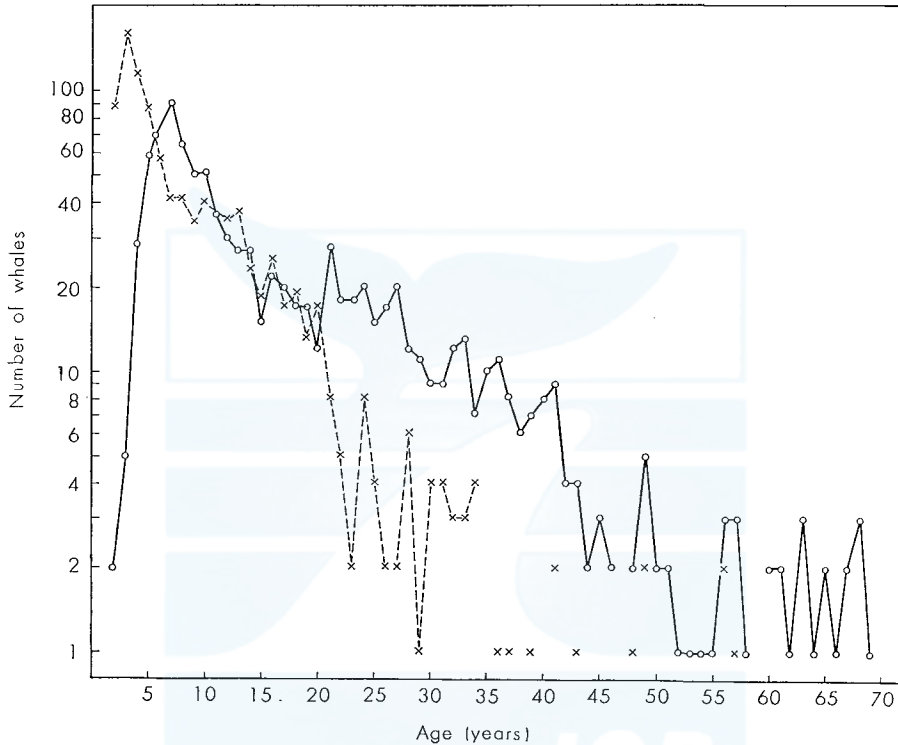

Fig. 10. Age compositions based on ear-plug laminations of the female fin whales caught in the north of east Aleutian Islands during the seasons from 1959 to 1961. Open circles and solid line: Annual accumulation rate is assumed as one, Cross and broken line: Annual accumulation rate is assumed as two.

Now, as shown in Fig. 10, catch curves are seemed to be separated to two straight lines excluding older age respectively in two accumulation rates. The cross point of two straight lines is estimated to be 15 years for the case of one-lamination age and 7 years for the case of two-laminations age.

If there is a population of which natural mortality coefficient (M) is constant and a constant fishing (coefficient is F) is operated to the population (more than A -age individuals are catchable), the logarithmic catch curves must be changed by years as shown in Fig. 11. Catch curves are separated to two straight lines. And right line has the same coefficient as M . On the other hand, left line has a coeffi-

ent which is $Z (=M+F)$. Cross point of these two lines moves according to the fishing years, and after t years, the cross point must become to $(A+t)$ -age.

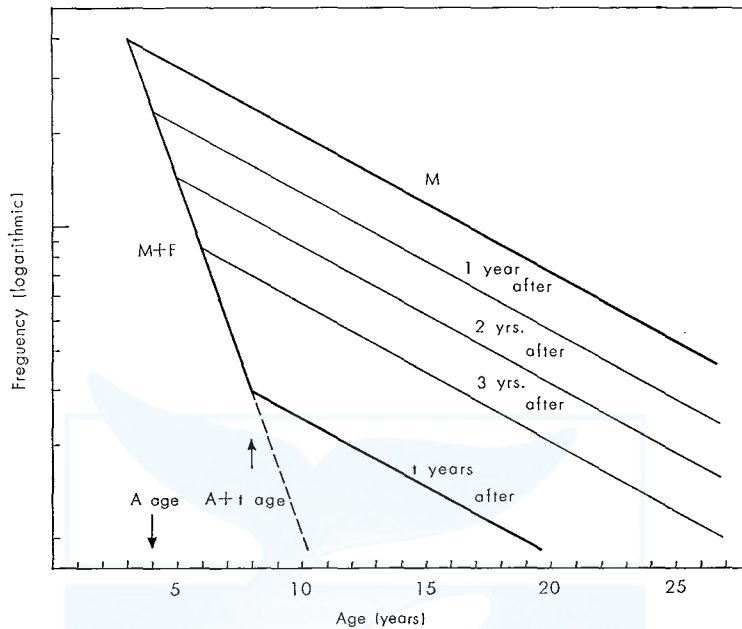

Fig. 11. Modelal catch curves according to the change of years, when a constant fishing effort (F) is given to a population of which natural mortality (M) is constant and recruit is constant.

When this modelal catch curves are able to adapt the actual catch-curves, the following factors must be chequed :

- 1) Natural mortality rate is constant: We cannot cheque on this factor. But in the one-lamination age, mortality is seemed to be constant during the ages from 15 to 40.
- 2) Recruitment to the age catchable is constant: We cannot know on this factor.
- 3) Fishing effort is constant: Table 9 shows the C.D.W. (catchers days work) in the operation in the north of east Aleutian Islands from 1954 to 1961. During the 8 years, C.D.W. are not always constant, and they vary between 110 and 350. But there is no tendency in the variation. And average of C.D.W. is 286.8.

Although there are above weak points, the actual curve is seemed to be adapted the modelal catch-curve.

On the cross point of two straight line, following result is obtained :

	A	t	A+t	Actual cross point
One-lamination age	7	6	13	15
Two-laminations age	3	6	9	7

As actual catch-curve is given from sum of 3 seasons 1959–1961, this is considered to be a catch curve in 1960. Therefore, t is 6 years. From above result, I cannot determine which curve is more suitable to truth, but deviation between actual cross point is 13% in one lamination age, on the other hand, it is 29% in two laminations

TABLE 9. CATCH EFFORTS FOR FIN WHALES IN THE NORTH OF EAST ALEUTIAN ISLANDS (Areas P 25 BS AND P 26 BS)

Year	Catchers*	Days work	C.D.W.	Average tonnage	No. of fin whales caught
1954	5	52	260	460.4	587
1955	9	50	450	504.0	1177
1956	10	33	330	572.7	773
1957	10	22	220	632.0	408
1958	10	11	110	657.2	299
1959	10	29	290	673.5	705
1960	10	37	370	688.8	948
1961	10	26	260	690.7	585

* Including scouting boats

age. More accurate result will be obtained in future on this subject by examining the tendency of change of age composition.

NATURAL AND FISHING MORTALITY RATE OBTAINED FROM AGE COMPOSITION BASED ON EAR-PLUG LAMINATIONS

From Table 9, natural mortality coefficient (M) and total mortality coefficient (Z) are calculated on two cases of annual accumulation rate of ear-plug laminations as follows:

Annual accumulation rate of ear-plug lamination	Z	M
One (one-lamination age)	0.192 (7–15)	0.067 (16–50)
Two (two-laminations age)	0.336 (3–7)	0.150 (8–25)

(): Range of age classes in the calculation

The values of Z and M in the latter case are about twice of the former. Fishing mortality coefficient (F) is calculated from Z and M values. That is,

$$F = Z - M$$

So, F values are given as 0.125 and 0.186 respectively for above two cases. Then total mortality rate ($1-S$), unconditional natural mortality rate ($D = \frac{M}{Z}(1-S)$) and exploitation rate ($E = \frac{F}{Z}(1-S)$) are calculated as follows:

Annual accumulation rate	$1-S$	D	E
One lamina	0.174	0.061	0.113
Two laminae	0.285	0.127	0.158

RELATION BETWEEN NATURAL MORTALITY RATE AND RECRUIT RATE

In the virgin stock, if natural mortality rate and pregnant rate in mature stage are constant throughout life, recruit rate is calculated presumably by the mortality rate and pregnant rate.

In the north of east North Pacific, the pregnant rate are obtained from mature and pregnant female whales caught as shown in Table 10.

Pregnant rates vary between 43.9% and 68.1%, and average rate during 8 years is 55.5%.

TABLE 10. PREGNANT RATE OF FIN WHALE CAUGHT IN THE NORTH OF EAST ALEUTIAN ISLANDS DURING 1954 TO 1961

Year	Mature females	Pregnant whales	Pregnant rate (%)
1954	224	139	62.1
1955	395	219	55.4
1956	269	118	43.9
1957	140	85	60.7
1958	64	41	64.1
1959	204	139	68.1
1960	337	164	48.7
1961	160	88	55.0
Total	1793	996	55.5

We consider that above pregnant rates do not show the true value, and I guess the rate is higher than the true value, because lactating animals are protected from catch by International Whaling Regulation, and so, most of them are not included into the figures in Table 10.

Now, recruit rate (R) are calculated in Table 11, when the first recruit number (number of whales born) is 1, sex ratio of females is 0.5, natural survival rate is S , age at sexual maturity is m , and pregnant rate is P , as follows:

$$R = P/2 (S^m + S^{m+1} + \dots + S^\infty)$$

$$= \frac{P \cdot S^m}{2} \left(\frac{1 - S^\infty}{1 - S} \right)$$

Then S is smaller than 1,

$$R = \frac{P \cdot S^m}{2(1 - S)}$$

Age at sexual maturity (m) is considered to be 5 years in the case of two-laminations age and 10 years in the case of one-lamination age. And true pregnant rate is not known, but I set the rate as 0.30, 0.40, 0.50, and 0.60. Then, the recruit rates are calculated as shown in Table 11.

If survival rate does not vary throughout life, in the range in which R is smaller than 1, the number of whales born become to be less than the previous number, and such a population cannot maintain the number of stock. Then, in general, the

mortality rate in calves is considerable to be more than the adults, so, the R -value calculated by above process must be fairly more than 1 in practice.

In one-lamination age, survival rate in which the stock continue the size are more than 0.93 and 0.90 respectively in the cases of which pregnant rates are 0.30 and 0.60. On the contrary, in two laminations age, they are more than 0.91 and 0.86 respectively.

TABLE 11. RECRUIT COEFFICIENT OF THE FIN WHALE CHANGING THE SURVIVAL RATES AND PREGNANT RATES

Age at sexual maturity s.r.\p.r.	10 years old				5 years old			
	0.60	0.50	0.40	0.30	0.60	0.50	0.40	0.30
0.97	7.38	6.15	4.92	3.69	8.60	7.17	5.73	4.30
0.96	5.00	4.16	3.33	2.50	6.13	5.11	4.09	3.06
0.95	3.60	3.00	2.40	1.80	4.65	3.88	3.10	2.33
0.94	2.69	2.25	1.80	1.35	3.67	3.06	2.44	1.83
0.93	2.08	1.73	1.39	1.04	2.98	2.48	1.99	1.49
0.92	1.63	1.36	1.09	0.82	2.51	2.09	1.67	1.25
0.91	1.30	1.08	0.86		2.08	1.73	1.39	1.04
0.90	1.04	0.87			1.77	1.48	1.18	0.89
0.89	0.85				1.52	1.27	1.02	
0.88	0.70				1.32	1.10	0.88	
0.87	0.53				1.15	0.96		
0.86	0.47				1.01			
0.85	0.39				0.88			

s.r.: Survival rate, p.r.: Pregnant rate

Now, the natural mortality rates were shown in previous section that 0.061 (survival rate is 0.939) in the case of one lamination age. This value satisfy the R -value even if pregnant rate is 0.30, and when pregnant rate is more than 0.30, the mortality rate is suitable for the continuance of the population size. On the other hand, the natural mortality rate in the case of two-laminations age is 0.127 (survival rate is 0.873). In this case R -value is lower than 1 when pregnant rate is lower than 0.50. Even if the pregnant rate is 0.60, R -value is 1.1. This value will be not safe for the continuance of population size, considering the higher mortality rate in the young stage.

Therefore, when the annual accumulation rate of ear plug is assumed to be two, the natural mortality rate calculated from age composition is too high for maintain the population size. On this point of view, the hypothesis of two-laminations age should be abandoned.

Purves & Mountford (1959) calculated the mortality rate from the age distribution based on ear-plug lamination on the fin whales in the Antarctic area I. And they got mortality coefficient. They are 0.133 in the female and 0.106 in the male. The figures are based on an assumed rate of formation of 2 laminations per year. Although Purves & Mountford did not consider the effect of whaling on the age distribution, they seem to recognize the figures show the natural mortality

coefficient. The coefficient in the female is similar to my result in 2 laminations age.

Laws (1961) calculated the mortality rate from the age distribution based on number of corpora in the ovaries on the female fin whale in the Antarctic area II in pre-war period when, as he estimated, fishing mortality was relatively small. The mortality coefficient is 0.0973 corresponding to annual mortality rate of 9.2%. In the calculation, the annual accumulation rate of corpora is assumed to be 1.43. However, Doi (in press) calculates the natural mortality rate comparing the change of number of fin whales catch per unit effort between the Antarctic pre-war and post-war seasons independently to the age distribution. And he got the result that the natural mortality rate is 5-7%.

CALCULATION OF FISHING AND SURVIVAL RATE
BY THE RECOVERY OF MARKED FIN WHALE

There are many undetermined factors for adaption of marking to population dynamics (Ricker, 1958). And I don't want to examine thoroughly the marking method for population dynamics. In this section, I examine the marking result only for check the fishing rate and total survival rate calculated by the age composition based on ear-plug laminations.

Table 12 shows the estimated number of fin whales marked in the north of east Aleutian Islands and number of whales recaptured among them during 1954 to 1962 seasons. Number of whales recaptured are variable according to the number of whales caught. Then, the number of whales recaptured are revised assuming that 1000 whales are caught in every year. Number of whales marked (M) and recaptured (R) are so small that the average value is considered to be more suitable for the examination.

Survival rate S is estimated by following formula (Ricker, 1958):

$$S = \frac{R_1 + R_2 + \dots + R_n}{R_0 + R_1 + \dots + R_{n-1}}$$

The number of recaptured whales in the same year of marking have many discussable factors, so I consider the data of the recovery in the same season must be excluded for this calculation, so the formula is revised as following:

$$S = \frac{R_2 + R_3 + \dots + R_n}{R_1 + R_2 + R_{n-1}}$$

The results are shown in Table 13. The calculated survival rate becomes more correct by the increment of elapsed years. In the last 4 cases in the table, survival rates are 79-86%.

The survival rate S calculated from age composition is 82.6% in the case of one lamination age, and 71.5% in the case of two laminations age. Then one lamination age corresponds to the result obtained from marking experiments. And the survival rate attained from age composition of two laminations age is considered to be too high.

Fishing mortality rate is calculated briefly as follows :

$$f = \frac{R_0}{M}$$

They are 5.1% and 8.3% respectively in actual and revised. But whaling and marking are operated almost parallelly in practice. So the twice of the calculated

TABLE 12. NUMBER OF FIN WHALES MARKED AND RECAPTURED IN THE NORTH OF EAST ALEUTIAN ISLANDS DURING 1954 TO 1962

A. Actual figure.

Year	No. of whales marked	Elapsed years from marking till recapture									Total	No. of whales caught
		0	1	2	3	4	5	6	7	8		
1954	210	7									7	585
1955	33	2	7(1)								9(1)	1177
1956	57	—	1(1)	2							3(1)	773
1957	41	3(1)	—	6(3)	1						10(4)	601
1958	28	1	7(2)	1	1	1					11(2)	455
1959	15	4	1	3	3	—	5(2)				16(2)	705
1960	11	—	2	—	6	1(1)	1	1			11(1)	1066
1961	23	5	—	—	2(1)	1	1	1	2		12(1)	587
1962	6	—	2	1	1	1	—	—	—	—	5	284
Total	424	22(1)	20(4)	13(3)	14(1)	4(1)	7(2)	2	2	—	84(12)	6233
average	47.1	2.44	2.50	1.86	2.33	0.80	1.75	0.67	1.00	—		

B. Revised figure when 1000 whales were caught in every year.

1954	210	12.0									12.0	1000
1955	33	1.7	6.0								7.7	1000
1956	57	—	1.3	2.6							3.9	1000
1957	41	5.0	—	10.0	1.7						16.7	1000
1958	28	2.2	15.4	2.2	2.2	2.2					24.2	1000
1959	15	5.7	1.4	4.3	4.3	—	7.1				22.7	1000
1960	11	—	1.9	—	5.6	0.9	0.9	0.9			10.3	1000
1961	23	8.5	—	—	3.4	1.7	1.7	1.7	3.4		20.4	1000
1962	6	—	7.1	3.5	3.5	3.5	—	—	—	—	17.6	1000
Total	424	35.1	33.1	22.6	20.7	8.3	9.7	2.6	3.4	—	135.5	9000
average	47.1	3.91	4.14	3.23	3.45	1.66	2.42	0.87	1.70	—		

() : Number of whales recaptured in other whaling areas or whales which were not known the position recaptured.

TABLE 13. TOTAL SURVIVAL RATE OF MARKED FIN WHALES CALCULATED

Elapsed years (n)	1954-1957		1954-1962	
	Actual	Revised	Actual	Revised
2	0.800	0.841	0.744	0.780
3	0.852	0.794	0.961	0.906
4	0.684	0.678	0.757	0.771
5	0.805	0.785	0.912	0.862
6	—	—	0.811	0.781
7	—	—	0.857	0.845
Fishing mortality rate	0.062	0.102	0.111	0.194

f will become near the truth. Then, they are 10.2% and 16.6% respectively. As the data concerning recoveries in the same year of marking have many discussive factors, the following formula (Ricker, 1958) are suitable for this purpose :

$$f = \frac{R_1 + R_2 + \dots + R_n}{SM(1 + S + \dots + S^{n-2})}$$

The results calculated from above formula is :

	1954-1957		1954-1962	
	Actual	Revised	Actual	Revised
S	0.805	0.785	0.857	0.845
f	0.062	0.102	0.111	0.194
D	0.133	0.113	0.032	-0.029

Fishing mortality rates are situated between 0.062 and 0.194. The calculated fishing mortality rates from age compositions are 0.113 and 0.158 respectively in one lamination age and two laminations age. The former rate corresponds to revised result of 1954-1957 and actual result of 1954-1962. And the latter is near the result of revised data 1954-1962. However, in the latter case the natural mortality rate obtained from marking experiment is smaller than 0 (-0.029). This cannot explain the actual phenomena, because the natural mortality rate should be more than 0. Therefore the fishing mortality rate of 0.194 is higher than the actual states of the whaling. Then, the one-lamination age agrees more with examination of fishing mortality rate from marking than the two laminations age.

CHANGE OF MATURITY RATE ACCOMPANIED WITH WHALING

Sexual maturity rate changes accompanying with the increasement of whaling years. Table 14 and Fig. 12 show the change of maturity rate of female fin whales caught in the north of east Aleutian Islands from the beginning of whaling in 1954 to 1961. The rate decrease by the increasement of years.

Now, taking following two model-age-compositions, and the change of sexual maturity rate are calculated from the beginning of whaling in Table 15.

	Model I (One lamination age)	Model II (Two laminations age)
Natural mortality rate	0.061	0.127
Fishing mortality rate	0.113	0.158
No. of whales in O year class	10,000	10,000
Age at sexual maturity	10	5
Age at recruitment for whaling	7	3
No. of whale caught before racruitment	No. of whales in age 7×2	No. of whales in age 3×1

In Model I, number of mature females at the begining of whaling is 87,363. If a quarter of the mature females is the number of female whales which are born, the number is 21,841. Whereas the first assumption of females which are born is 10,000. From this calculation we can recognize that the natural mortality rate in young stage is fairly large. By the way, in Model I, whaling does not influence to

the recruitment at least until 7th years after the beginin of whaling. In practice, there are whales caught before the age at recruitment for whaling, as shown Table 15, so, I assumed the whales as the twice of the number of whales at the age of recruitment (12,873). In Fig. 12, the change of maturity rate of Model I is similar to the actual change of the maturity rate.

TABLE 14. ACTUAL NUMBER OF SEXUALLY MATURE AND IMMATURE FEMALE FIN WHLES CAUGHT IN THE NOTH OF EAST ALEUTIAN ISLANDS DURING THE SEASONS FROM 1954 TO 1961.

Year	Immature	Mature	Mature rate (%)
1954	80	224	73.7
1955	166	395	70.4
1956	103	269	72.3
1957	70	140	66.7
1958	77	64	45.4
1959	153	204	57.1
1960	223	337	60.2
1961	135	160	54.2
Total	1007	1793	64.0

TABLE 15. CALCULATED NUMBER OF TOTAL AND MATURE FEMALES CAUGHT IN THE CASES OF MODELS-I AND -II.

Model-I: $D=0.061$, $E=0.113$ (One-lamination age).

Year	Total	Mature	Mature rate (%)
1st	118391.2	87362.6	73.8
2nd	106468.8	76849.9	72.2
3rd	96621.9	67601.8	70.0
4th	88483.7	59465.6	67.2
5th	81765.2	52747.1	64.5
6th	76287.7	47269.6	62.0
7th	71589.8	42611.7	59.5
8th	67842.9	38824.8	57.2

Model-II: $D=0.127$, $E=0.158$ (Two-laminations age).

Year	Total	Mature	Mature rate (%)
1st	59041.4	39926.6	67.6
2nd	50764.8	32701.1	64.4
3rd	44846.8	26782.7	59.7
4th	<40614.8	22551.0	>55.5
5th	<37589.3	19525.5	>51.9
6th	<35425.8	<17362.0	>49.0
7th	<33879.4	<15815.6	>46.7
8th	<32773.1	<14709.3	>44.9

However, in model II, even in the virgin stock, the number of whales born is lower than the firstly assumed number of whales born which can maintain the population size. Then the whaling will influence to the number of recruitment for whaling after 3 years.

Assuming the number of whales caught before the age of recruitment to be as

the same as number of whales at the age of recruitment, the maturity rates are lower than the actual figures.

After 3 years from the start of whaling, the number of recruit becomes to be smaller than the virgin stock. Then, as the number of immature whales become relatively smaller, the maturity rate must be higher than the calculated rate. In Fig. 12, the estimated changes of maturity rate are shown. This estimated change in Model II does not correspond the feature of the actual data.

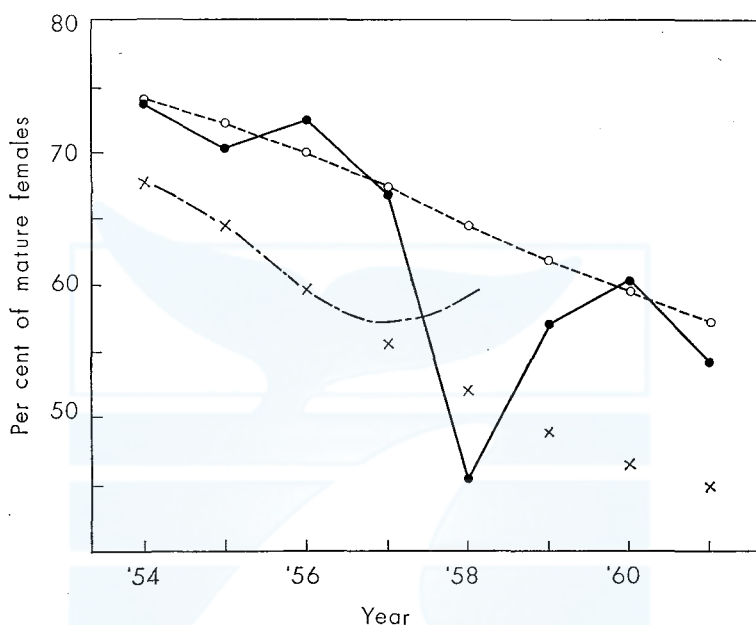

Fig. 12. Change of sexual maturity rate of the female fin whales for actual and two models. Open circle and straight line: Actual data from the female fin whales caught in the north of east Aleutian Islands, Closed circle and solid line: Model I, Cross and broken line: Model II.

In conclusion, the actual change of maturity rate correspond fairly with Model I (the accumulation rate is one annually), but those of which Model II is not consistent with the actual change.

DISCUSSION

By some examinations which were described above, I conclude that the annual ear-plug accumulation rate must be under two which is nowadays recognized by us, and I showed some examples for estimation that the annual accumulation rate may be near one.

Indeed, ear plug is the best of age characters in the fin whale, but there are many points which must be investigated further. One of them is a standardization of lamination count. As Ichihara (1963) reported, there is individual discrepancy in lami-

nation count. And the photometric method which Ichihara (1963) manufactured for trial must be developed further for this purpose. When standardization of ear plug reading is established, and if the new reading becomes different to the present reading, the above examinations should be re-examined. The second point to be investigated in future is the periodicity of laminae formation. Purves (1955) considered the migratory period as the relation of laminae formation. However, Clarke (1962) reported the feeding of fin whales off the coast of Chile in October and November. And according to Mackintosh (1942) and Nemoto (1962), food of whales are scanty in the lower latitude, and the baleen whales do not feed so much in winter season. If the mechanism of formation of ear-plug lamination is coincided to the nutrition, the formation of ear-plug lamination must have more relation with the winter (reproductive season) or summer (feeding season) than the migratory seasons. Ridges of baleen plates are also considered to have relation with nutrition (Ruud, 1940, 1945). If so, the periodicity of formation of ear-plug lamination and ridges of baleen plates should be the same each other. My result of correlation between baleen ridges and ear-plug lamination briefly support on the same mechanism of formation between two characters. On the lamination formation, Purves & Mountford (1959) and Ichihara (1959) described on possibility as shown in Introduction. Furthermore, Mr. Ichihara suggests me the possibility of the change of periodicity of ear-plug lamination by the age. We must investigate the formation mechanism of ear-plug lamination. Then the factors concerning the formation of laminae will be known, and it will be solved the annual rate and whether the periodicity of formation are variable or constant.

My second conclusion is on the annual ovulation rate of the fin whale. The rate must be less than 1.4 which as Laws (1961) studied thoroughly. I got a result that it may be near 0.5 although there are individual variations and the difference among the different stocks as shown by Nishiwaki, Ichihara & Ohsumi (1958) and Fujino (1963), and Kimura (1956) reported the tendency of multiple ovulations in the course of increase of age by this study of twinning.

The annual ovulation rate is very important not only for the age determination but also for the reproductive physiology of the whales. According to my result, the fin whale ovulates in average one every two years. Then pregnancy rate may be under 50%, because there are evidence that some corpora albicantia are non-pregnant (Laws, 1961). Apparent pregnancy rate is 55% in my material, but I consider that they are higher than the true rate. Although Laws (1961) considered that over 80% of females wean their calves before they enter the pelagic whaling grounds, Chittleborough (1958) reported that the weaning period of humpback whales is 10 months. And there are other observations on the suckling of dolphins. According to Tavolga & Essapian (1957) and Nakajima et al. (1962), bottlenose dolphin (*Tursiops sp.*) suckles for over 1 year in aquarium. Although we have no data on direct observation of weaning period in the fin whale and above data are given by other species, I think the lactating stage of the fin whale will be longer than previous descriptions (Mackintosh & Wheeler, 1929; Laws, 1961). Mackintosh & Wheeler (1929) suggest that for the nursing period the lactat-

ing females are segregated from the main herds, so that all lactating females do not appear on the whaling grounds. And in the whaling grounds, the taking of calves or females accompanied with calves are prohibited by the International Whaling Convention. Therefore, the pregnant rate calculated by actual data are considered to be higher than the true rate.

Concerning this subject, Laurie (a letter to Purves & Mountford, 1959) also discussed and he wrote, if so, annual increment of corpora in the blue whale must be lower than 1.13 and connected as 0.69. Further ecological knowledges are need on this problem. I think that the two-years breeding cycle will be common in the fin whale, but there will be some individuals whose breeding cycle is more than two years.

In the examination on the relation between ear-plug laminations and baleen plate ridges, there are some material which are not able to explain by the correspondance one to one. The number of ridges is more than the number of ear-plug lamination. As one of the caution, the discount of ear-plug lamination or baleen ridges is considerable, but more collection and comparison are needed on this subject especially on the calves.

SUMMARY

1. Age determination of the fin whale (*Balaenoptera physalus* L.) was examined by some methods.

2. Considering the elapsed time from marking, the annual accumulation rate of ear-plug lamination of marked whales recaptured should be less than two, and there is no whale of which number of ear-plug lamination divided by elapsed years is less than one.

3. Sexually immature rate of recaptured whales decrease with the increasement of elapsed years. And from the tendency of the decrease of immature rate, the age at sexual maturity is estimated to be about 10 years.

4. Numbers of corpora lutea and albicantia in the ovaries of recaptured fin whales divided by elapsed years are able to be explained more easily in the assumed case which the annual ovulation rate is 0.5, and age at sexual maturity is 10 years.

5. Relation between the ear-plug lamination and mean number of corpora shows that annual accumulation rate of corpora is 0.49 in the fin whales caught in the Antarctic areas IV and V, if one lamination accumulates in a year.

6. Percentage of sexual maturity in successive the number of ear-plug lamination shows that the number of ear-plug lamination corresponding to 50% of sexual maturity is 9.4 in males and 10.7 in females.

7. Before the tip of baleen plates begin to wear, number of ear-plug lamination coincide the number of ridges on baleen plates.

8. Age compositions of the female fin whales caught in the north of east Aleutian Islands based on ear-plug lamination are drawn in following two cases. And the natural mortality rate (D) fishing mortality rates (E) and total mortality rate (Z) are calculated as follows :

Annual rate	Z	D	E
One lamination	0.174	0.061	0.113
Two laminations	0.285	0.127	0.158

9. In the virgin stock, relation between natural mortality rate and recruit rate is discussed. And natural mortality rate in the case of two laminations age is considered to be too high for maintainance of the stock size.

10. Examining the number of fin whales marking and recovery in the north of east Aleutian Islands, survival rate is calculated to be 79~86%. And the fishing mortality rate is also calculated from the data. It is 10-12%.

11. Yearly change of sexual maturity among the actual, Models I and II populations are compared. And the change of Model I (annual rate is one lamination) is suitable to the actual change. On the contrary, Model II (annual rate is two laminations) is not able to explain the actual change.

12. Thinking collectively above examinations, it will be concluded that the annual accumulation rate of ear-plug lamination must be less than two, probably near one, and average annual ovulation rate will be under one, probably near 0.5, although there are individual and racial variations. In addition, the average age at sexual maturity will be older than 5 years, probably 9~11 years. Of course there are individual variation in the age of sexual maturity.

13. The standardization of the reading of ear-plug lamination should be established, and after then above examinations must be re-examined.

ACKNOWLEDGEMENT

Marking material used in this paper are based on the endeavors by Discovery Committee and National Institute of Oceanography which have been engaged to the whale marking in the Antarctic from 1932, International Whales Marking Program in the Antarctic from 1954 and the Fisheries Agency of Japanese Government which have marked into the whales in the North Pacific since 1949. Unless the endeavors by above Agencies, present examinations would not be studied. I am indebted to above Agencies for use the material. I would like to thank Mr. S. G. Brown who kindly checked the marking data in the Antarctic.

And this paper could not be written unless the strenuous efforts of the biologists who investigated, collected and examined the material under the leading by Dr. Omura, Director of the Whales Research Institute. In particular, Dr. M. Nishiwaki, Dr. K. Fujino, Dr. T. Nemoto, Mr. T. Ichihara and Mr. K. Nasu of the Whales Research Institute. I due especially to Mr. T. Ichihara and Dr. M. Nishiwaki, on the reading of ear-plug laminations. I wish to thank them.

My sincere thanks are due to Dr. H. Omura and Dr. M. Nishiwaki of the Whales Research Institute and Dr. T. Hibiya, Assistant Professor of the University of Tokyo for their guidance throughout the work.

Dr. F. Nagasaki of the Fisheries Agency of Japan and Dr. N. Doi of Tokai Resional Fisheries Research Laboratory kindly suggested me the method for analyzing the population dynamics. Dr. R. M. Laws of the former staff of National Institute

of Oceanography kindly corrected some parts of my draft and gave me suitable criticism. I have benefited from discussions with Mr. T. Ichihara. I should like to thank them.

Finally, I am much indebted to many members of the Japanese whaling companies for the help to investigation and collection of the materials.

REFERENCES

- Brown, S. G. (1962 a). The movements of fin and blue whales within the Antarctic Zone. *Discovery Rpts.* 33: 1-54.
- (1962 b). Whale marks recovered during Antarctic seasons 1960/61, 1961/62 and in South Africa 1962. *Norsk Hvalfangst-Tid.*, 51 (11): 429-34.
- Chittleborough R. G. (1958). The breeding cycle of the female humpback whale, *Megaptera nodosa* (Bonaterre). *Aust. J. Mar. Freshw. Res.*, 9 (1): 1-18.
- (1959 a). Australian marking of humpback whales. *Norsk Hvalfangst-Tid.*, 48 (2): 47-55.
- (1959 b). Determination of age in the humpback whale, *Megaptera nodosa* (Bonaterre). *Aust. J. Mar. Freshw. Res.* 10 (2): 125-43.
- (1960). Marked humpback whale of known age. *Nature* 187: 164.
- Chittleborough, R. G. & Godfrey, K. (1957). Review of whale marking and some trials of a modified whale marks. *Norsk Hvalfangst-Tid.*, 46 (5): 485-508.
- Clarke, R. (1962). Whale observation and whale marking off the coast of Chile in 1958 and from Ecuador towards and beyond the Garapagos Islands in 1959. *Norsk Hvalfangst-Tid.*, 51 (7): 265-87.
- Clarke, R. & Brown, S. G. (1957). International co-operation in Antarctic whale marking from 1945 to 1957. *Norsk Hvalfangst-Tid.*, 46 (9): 513-7.
- Dawbin, W. H. (1959a). Evidence on growth-rates obtained from two marked humpback whales. *Nature* 183: 1749-50.
- (1959 b). New Zealand and South Pacific whale marking and recoveries to the end of 1958. *Norsk Hvalfangst-Tid.*, 48 (5): 213-38.
- Doi, T. (1964). Estimation of coefficient of natural mortality rate of fin whale population in the Antarctic. *Bull. Tokai Reg. Fish. Res. Lab.*, 38 (In press)
- Fujino, K. (1960). Immunogenetic and marking approaches to identifying subpopulations of the North Pacific whales. *Sci. Rep. Whales Res. Inst.*, no. 15: 85-142.
- (1963). Population genetics of whales with reference to blood types. *Bull. Jap. Soc. Sci. Fish.* 29 (12): 1133-8
- Hysten, A., Jønsøgaard, A., Pike, G. C. & Ruud, J. T. (1955). A preliminary report on the age composition of Antarctic fin whale catch 1945/46 to 1952/53 and some reflections on total mortality rates of fin whales. *Norsk Hvalfangst-Tid.*, 44 (10): 577-89.
- Ichihara, T. (1959). Formation mechanism of ear plug in baleen whales in relation to glove-finger. *Sci. Rep. Whales Res. Inst.*, no. 14: 107-135.
- (1963). Photometric method for counting laminae in ear plug of baleen whale. *Sci. Rep. Whales Res. Inst.*, no 17: 37-48.
- (1964). Prenatal development in ear plug of baleen whale. *Sci. Rep. Whales Res. Inst.*, no. 18: 29-48
- Kimura, S. (1957). The twinning in southern fin whales. *Sci. Rep. Whales Res. Inst.*, no. 12: 103-25.
- Laurie, A. H. (1937). The age of female blue whales and the effect of whaling on the stock. *Discovery Repts.* 15: 223-84.
- (1959). See Purves & Mountford (1959).
- Laws, R. M. (1960). Problems of whale conservation. *Trans. N. Amer. Wildlife Conf.* 25: 304-19.
- (1961). Reproduction, growth and age of southern fin whales. *Discovery Repts.* 31: 327-486.
- Laws, R. M. & Purves, P. E. (1956). The ear plug of the Mysticeti as an indication of age with special reference to the North Atlantic fin whale. *Norsk Hvalfangst-Tid.*, 45 (8): 413-25.

- Mackintosh, N. A. (1942). The southern stocks of whalebone whales. *Discovery Repts.* 22: 197-300.
- Mackintosh, N. A. & Wheeler, J. F. G. (1929). Southern blue and fin whales. *Discovery Repts.* 1: 257-540.
- Nakajima, M., Takahashi, K., Ogura, M. & Sawaura, K. (1963). On the growth of infants of the small size toothed whales. *J. Jap. Zool and Aquarium.* 5 (1): 16-22 (In Japanese)
- Nemoto, T. (1962). (Food of baleen whales) *Geiken Soshyo* no. 4: 136 pp. (In Japanese)
- Nishiwaki, M. (1950a). Determination of the age of Antarctic blue and fin whales by the colour changes in crystalline lens. *Sci. Rep. Whales Res. Inst.*, no. 4: 115-61.
- (1950 b). Age characteristics in baleen plates. *Sci. Rep. Whales Res. Inst.* no. 4: 162-83.
- (1951). On the periodic mark on the baleen plates as the sign of annual growth. *Sci. Rep. Whales Res. Inst.*, no. 6: 133-52.
- (1952). On the age-determination of Mysticoceti, chiefly blue and fin whales. *Sci. Rep. Whales Res. Inst.*, no. 7: 87-119.
- (1957). Age characteristics of ear plugs of whales. *Sci. Rep. Whales Res. Inst.*, no. 12: 23-32.
- Nishiwaki, M. & Yagi, T. (1953). On the age and the growth of teeth in a dolphin (*Prodelphinus caeruleo-albus*) (1). *Sci. Rep. Whales Res. Inst.*, no. 8: 133-46.
- Nishiwaki, M., Ichihara, T. & Ohsumi, S. (1958). Age studies of fin whales based on ear plug. *Sci. Rep. Whales Res. Inst.*, no. 13: 155-69.
- Ohsumi, S. (1962). Biological material obtained by Japanese expedition from marked fin whales. *Norsk Hvalfangst-Tid.*, 51 (5): 192-8.
- Ohsumi, S., Nishiwaki, M. & Hibiya, T. (1958). Growth of fin whales in the northern Pacific. *Sci. Rep. Whales Res. Inst.*, no. 13: 97-133.
- Ohsumi, S., Kasuya, T. & Nishiwaki, M. (1963). The accumulation rate of dentinal growth layers in the maxillary tooth of the sperm whale. *Sci. Rep. Whales Res. Inst.*, no. 17: 15-35.
- Omura, H. (1955). Whales in the northern part of the North Pacific. *Norsk Hvalfangst-Tid.*, 44 (6): 323-45, 44 (7): 395-405.
- Omura, H. & Kawakami, T. (1956). Japanese whale marking in the North Pacific. *Norsk Hvalfangst-Tid.*, 45 (10): 555-63.
- Peters, N. (1939). Über Grösse, Wachstum und Alter des Blauwales (*Balaenoptera musculus* (L)) und Finnwales (*Balaenoptera physalus* (L)). *Zool. Anz.* 127: 193-204.
- Purves, P. E. (1955). The wax plug in the external auditory meatus of the Mysticeti. *Discovery Repts.* 27: 293-302.
- Purves, P. E. & Mountford, M D. (1959). Ear plug laminations in relation to the age composition of a population of fin whales (*Balaenoptera physalus*). *Bull. British Mus. (H.N.). Zool.* 5 (6): 6-161.
- Rayner, G. W. (1940). Whale marking. Progress and results to December 1939. *Discovery Repts.* 19: 245-84.
- Ricker, W. E. (1958). Handbook of computations for biological statistics of fish populations. *Bull. Fish. Res. Board Canada* no. 119: 300 pp.
- Ruud, J. T. (1940). The surface structure of the baleen plates as a possible clue to age in whales. *Hvalradets Skrifter* nr. 23: 24 pp.
- (1945). Further studies on the structure of baleen plates and their application to age determination. *Hvalradets Skrifter* nr. 29: 69 pp.
- Ruud, J. T., Clarke, R. & Jonsgard, A. (1953). Whale marking trials at Steishamn, Norway. *Norsk Hvalfangst-Tid.*, 42 (8): 429-41.
- Sergeant, D. E. (1959). Age determination in Odontocete whales from dentinal growth layers. *Norsk Hvalfangst-Tid.*, 48 (6): 273-88.
- (1962). The biology of the pilot or pothead whale, *Globicephala melaena* (Traill) in Newfoundland waters. *Bull. Fish. Res. Board Canada* no. 132: 84 pp.
- Tavolga, M. C. & Essapian F. S. (1957). The behavior of the bottle-nosed dolphin (*Tursiops truncatus*): Mating, pregnancy, parturition and mother infant behavior. *Zoologica* 42 (1): 11-31.
- Tomilin, A. G. (1945). (The age of whales as determined from their baleen apparatus). *C. R. Acad. Sci. Dokl. Acad. Nauk.. SSSR.* 49 (6): 460-3.
- Wheeler, J. F. G. (1930). The age of fin whales at physical maturity. *Discovery Repts.* 2: 403-34.

SCHOOL OF BALEEN WHALES IN THE FEEDING AREAS

TAKAHISA NEMOTO

From the ecological point of view, the school of the baleen whale is one of the most important theme although it has not been fully studied. The observations on the school of whales from the aircraft, ships and the marking cruise have been carried out (Chittleborough, 1953 : Clarke & Ruud, 1954 : Brown, 1957 : 1958 : Nemoto, 1959 : Clarke, 1962), however, these are descriptions on the constituent number of whales in schools in general.

Andrews (1914), Slijper, (1958) and Nemoto, (1959) discuss the schools of baleen whales considering the socionomic sex ratio, the affection, number of whales and the mutual help among whales in a school. Some studies and discussions on the ecological segregations in the migrations of certain baleen whales also have been done, (Mackintosh, 1942 : Fujino, 1960 : Laws, 1961 : Nemoto, 1959 : 1962b), but it may be generally accepted that there has been few ecological study on the school of baleen whales.

The catch data and the whale marking results of the whales in the North Pacific and the Antarctic waters give biologists many materials, and I examine here them chiefly in the feeding grounds. The number of baleen whales in a school and the sex ratio are checked in a first step. Sexual maturity in each member of a school is also important for this study, however, it is impossible to examine the whales observed in the marking cruise in the sea. The most reliable data on the sexual conditions of the baleen whales are obtained through the investigations carried out in the factory ships, in the whaling stations, in the North Pacific and in the Antarctic. It should be noted that the most part of the sexual conditions are obtained in the feeding areas, not in the breeding areas in the lower latitudes. I would think the schools of baleen whales should be examined also in the breeding areas, in which the meaning of the school of baleen whales is somewhat different from that of schools in the feeding areas.

The whaling has been oppressing whales and have the great influence on the conditions of baleen whales such as migrations, reproductions and formations of schools. Especially the whaling in the feeding grounds break up the schools by the catch, and this affects the data treated here too.

Several populations are considered both in the Antarctic and in the North Pacific, and individual numbers of baleen whales effect the schooling of them. But materials are treated here as a whole in each whaling areas, Antarctic, North Pacific, and adjacent waters to Japan. Futher consideration will be made in due course on these points.

The term 'school' of baleen whales is also said in other ways, pod, herd and group. 'School' and 'herd' are commonly used in the biology of whales, and I use here the word 'school' for the baleen whales. According to Clarke, (1956)

the old whalers distinguished 'pods' or 'gams' numbering up to about twenty whales, 'schools' or 'shoals' of some twenty to fifty, and the 'herd' or 'body of whales' comprizing some fifty to serveral hundred. The term 'herd' is used mostly for the land mammals ungulates, 'school' for fish, and group' is used for the general expression in the recent ecology.

MATERIALS

The materials treated here consist of two parts. One is the marking data in the North Pacific, adjacent waters to Japan and the Antarctic ocean. The another is the catch data in the North Pacific by the Japanese factory ships in 1955 and 1956. The marking data base on three groups described following.

North Pacific	1953.....1961
Adjacent waters to Japan and Bonin Islands	1949.....1955
Antarctic	1954.....1961

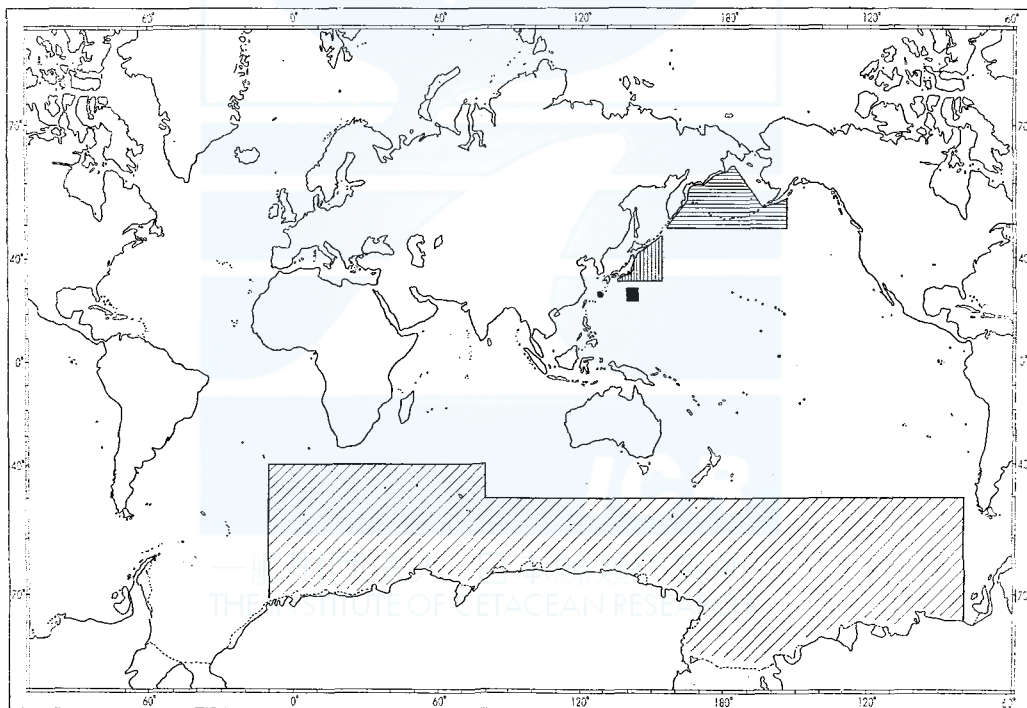

Fig. 1. The whaling grounds where the observations on the schools of baleen whales have been carried out. Lateral line—North Pacific pelagic: Straight line—Coast of Japan: Black circle—Okinawa, Black square—Bonin Island pelagic: Oblique line—Antarctic pelagic.

From the marking data, the number of whales in a school is discussed as well as the formations of the school of different species of baleen whales. The

socionomic sex-ratio and sexual conditions are mostly obtained from the biological data based on the whales caught in the North Pacific. The pair schools of cow and calf have been obtained through the marking research, and the variation in the number of baleen whales in a school from the marking and catch results both in the North Pacific and the Antarctic. These research areas are shown in Fig. 1.

SCHOOL OF BALEEN WHALES IN THE NORTH PACIFIC,
FIN WHALES (*BALAENOPTERA PHYSARUS*)

Number of fin whales in a school

The number of fin whales in a school has been discussed by Clarke & Ruud (1954) Nemoto (1959) and Clarke (1962). According to their reports and other descriptions (Chitterborough, 1953 etc), fin whales have been mostly found four or less in a school in the feeding areas. The schools consist of five or more whales are

TABLE 1. NUMBER OF FIN WHALES IN A SCHOOL
IN THE NORTH PACIFIC IN 1956

	Number of fin whales in a school									
	1	2	3	4	5	6	7	8	9	10~
June	62	88	32	17	8	3	2	—	—	—
July	178	204	100	72	32	9	5	10	—	18
Aug.	64	151	52	28	9	7	3	3	—	13
Sept.	1	2	—	—	—	—	—	—	—	—
Total	305	445	184	117	49	19	10	13	—	31

TABLE 2. SEASONAL OCCURRENCES OF SINGLE
FIN WHALES IN THE NORTHERN PACIFIC

	May		June		July		Aug.		Sept.		Total	
	Male	Female	Male	Female	Male	Female	Male	Female	Male	Female	Male	Female
1955	3	5	13	9	103	81	38	33	41	45	198	173
1956	—	—	26	36	78	100	28	36	—	1	132	173

TABLE 3. OCCURRENCES OF IMMATURE FIN WHALES
IN THE SINGLE SWIMMING FIN WHALE

	Mature		Imm.		Preg.	
	Mature	Imm.	Mature	Imm.	Mature	Imm.
1955	164	34	128	45	71 (55.5%)	
1956	110	22	141	32	62 (43.9%)	

comparatively scarce. The number of fin whales in a school in the North Pacific in 1956 is shown in Table 1 on 1298 fin whales. The number of fin whales in a school vary with the proceeding of the seasons, and the single swimming fin whale decreases in number in the late of summer (Nemoto, 1959).

This tendency is clearly shown in the Table 1 and Fig. 2. The one of the main reasons for the fact may be the leaving of the single swimming pregnant female to the breeding area as it has been considered (Mackintosh, 1942; Nemoto, 1959; Laws, 1961), however, July in the North Pacific must be the feeding season for fin whales and they come to the feeding areas in July successively. The forma-

tion of the school in the feeding areas also should be considered as suggested by the previous report (Nemoto, 1959).

Single swimming fin whale

From the observations in the catcher boats chasing fin whales are used for the examination. The seasonal occurrences of male and female in single swimming fin whales is given in Table 2 and 3 according to the data in 1955 and 1956. There is no consistent tendency in the occurrence of each sex, and no clear tendency in the occurrences of immature and pregnant whales too. It has been generally ac-

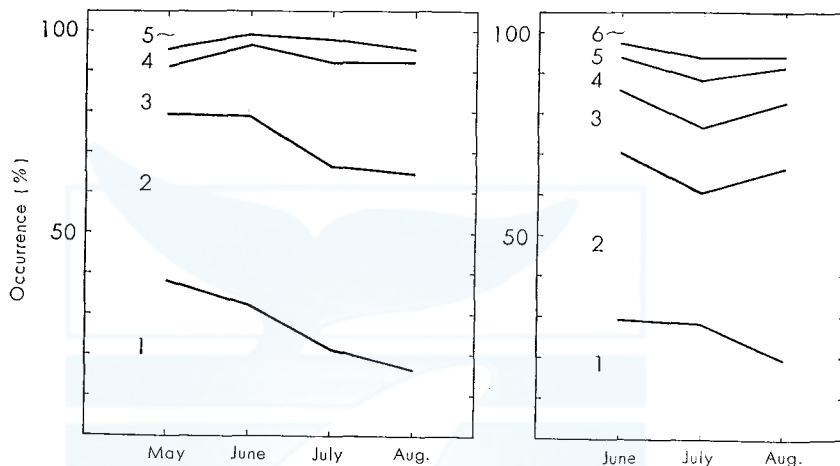

Fig. 2. Seasonal variations of the number of fin whales in a school in the North Pacific. Left—1954; Right—1956.

cepted that there are some ecological segregations in the baleen whales according to the sex and sexual conditions. But there is no peculiar feature in the characters of the fin whales in the data in 1955 and 1956. The pregnant ratio is also not so high or low comparing with other fin whales caught. Five lactating fin whales are present out of fifteen resting whales in 1955. The occurrence of the immature fin whales are also not so different from the total catch of the fin whale. This may partly be affected by the size regulation in the whaling. The shorter young fin whales may sometimes form a large school but they are saved from the catch. As a conclusion, single swimming fin whales in the feeding areas show no peculiar feature. But it will be re-examined by the further accumulated data in due course.

Pair fin whales

The catch data of the pair fin whales are not so large in number. Twenty-six pairs of fin whales in 1955 and sixty pairs in 1956 are caught by whaling, the occurrences of each sex of which are illustrated in Table 4. The combination of male and female is dominant among three combinations. Male and male combinations exceeds female and female combinations. This may be due to one reason of the affection between male and female from the school. The sexual conditions of

those pair fin whales are as follows. Although the number of cases is not so large, the immature combination of male and female is scarce. In the pair of female fin whales, the occurrences of the combinations of mature and immature females and immature combination are observed. Among the pregnant females in the pair of two female fin whales, there are two cases of the two female fin whales pregnant out of seven. Among the mature male and female pairs, four male and female combinations are pregnant out of nine in 1955. Twelve pairs out of twenty-five have the pregnant female and others are resting in 1956. From the above facts, it is considered that all these pairs of mature male and female fin whales are not the

TABLE 4. SEXUAL COMBINATIONS OF TWO FIN WHALES IN A SCHOOL IN THE NORTH PACIFIC (%)

	Female & Female	Female & Male	Male & Male	Total
1955	4(15.4)	16(61.5)	6(23.1)	26
1956	11(18.4)	33(55.0)	16(26.6)	60

TABLE 5. SEXUAL MATURITY IN TWO FIN WHALES IN A SCHOOL IN THE NORTHERN PACIFIC IN 1955 AND 1956

	F.* & F.			F. & M.*			M. & M.		
	F.* & F.	F. & M.*	M. & M.	F. & F.	F. & M.	M. & M.	F. & F.	F. & M.	M. & M.
Both Mature	1	9	4	6	25	12			
Female Imm.	—	3	—	—	5	—			
Male Imm.	—	2	—	—	2	—			
One Imm.	3	—	2	2	—	3			
Both Imm.	—	2	—	3	1	1			

* M—Males, F—Females.

TABLE 6. OCCURRENCES OF MALE AND FEMALE FIN WHALES IN ONE FIN WHALE CAUGHT FROM A SCHOOL OF TWO FIN WHALES IN THE NORTH PACIFIC

	Female			Male		
	Mature	Imm.	Total	Mature	Imm.	Total
1955	95(57)	37	132	119	21	140
1956	127(56)	43	170	181	34	215

Numbers in bracket are pregnant females.

school from the breeding areas. Some of them may be formed in the feeding areas because these resting females are sometimes considered not to migrate to the breeding areas.

Three of female fin whales pairs are not pregnant, and other two cases have pregnant females in the pairs. Three cases of mature and immature fin whales out of five, the adult female fin whales are pregnant.

It seems that the more common pairs of fin whales in the feeding areas is composed of different sex fin whales, namely the pair of male and female. The tendency is confirmed by the catch of one fin whale from the pair of two fin whale's school. The number of fin whales caught as only one whale catch from the pair of two fin whale's school are shown in Table 6. The sex ratio is high in male both in 1955 and 1956. Generally speaking, the females are larger than males in *Ba-*

laenoptera whales, the selection may choose females better. But the contrary to this, the male is dominant. If the ratio of male and female fin whales is the same as it is seen in the former example in the pair of two fin whales, the probability of male from the pair fin whales is 0.539 in 1955 and 0.542 in 1956. The sex ratio of male is 0.515 in 1955 and 0.558 in 1956 which fairly coincide with the calculations. These combinations of the pair fin whales may be consistent both in two years in 1955 and 1956. The occurrences of immature fin whales do not differ from those of the catch of two fin whales in pair, however, the slight high maturity ratio is observed comparing with the single swimming fin whales. The pregnant ratios are 0.60 in 1955 and 0.44 in 1956 respectively which show no peculiar tendency.

Three fin whales in a school

The observation and chasing for three fin whales school are far less than the single and pair fin whales. There have been five cases in 1955 and only one in 1956. As shown in Table 7, one school is composed of all males, and three cases of two males and one female and one case of one male and two females. The three males in the male trio are sexually mature, however, one of which is just mature. Perhaps it is not the potential male and it may not play the active sexual behaviour considering the weight of the testis, 2.5 and 3.0 kg, (Nemoto, 1962).

TABLE 7. SEXUAL COMBINATION IN A SCHOOL OF THREE FIN WHALES IN THE NORTH PACIFIC IN 1955 AND 1956

	Sexual combination		
	3 males	2 males & 1 female	1 male & 2 females
1955	—	3	2
1956	1	—	—

TABLE 8. SEXUAL OCCURRENCES IN THE CATCH OF TWO FIN WHALES FROM THE SCHOOL OF THREE FIN WHALES IN THE NORTH PACIFIC IN 1955 AND 1956

	Sexual combination		
	Male & Male	Male & Female	Female & Female
1955	7	17	7
1956	14	15	5

One mature male and one mature but resting female and immature female make the school in one case, and one immature male, pregnant female and resting female make the another school of one male and two females. There are three cases of two males and one female. The mature males and one immature female are found in two cases, two mature males and a mature pregnant female are found in another case.

It is very difficult to get general tendencies about the school of three fin whales, however, it is interesting to note that two males and one female combinations occupy the first rank. The period of pregnancy is about a year in fin whales (Ohsumi, Nishiwaki & Hibiya, 1957; Laws, 1961), and the nursing may be about seven months. The number of males is dominant owing to above reason in schools as usually the cow and calf pair do not allow the joining of other male whales in the feeding areas.

There are rather many examples of the catch of two whales from the school of three fin whales. The occurrences of each sex are given in Table 8. The combination of male and female is dominant through the catch in 1955 and 1956, and two males' pair stands as the second. Especially fourteen pairs of males are caught out of thirty-four examples in 1956. As compared with the occurrences of three males school in 1956, it is the same tendency in the catch of the two fin whales from the schools of three fin whales. In 1955, seventeen pairs of male and female are caught

TABLE 9. SEXUAL CONDITIONS IN THE CATCH OF TWO FIN WHALES FROM THE SCHOOL OF THREE FIN WHALES IN THE NORTH PACIFIC IN 1955 AND 1956 EXCLUDING UNKNOWN PAIRS

	Sexual combination					
	Male & Male		Male & Female		Female & Female	
	1955	1956	1955	1956	1955	1956
Both mature	5	11	11	10	5	3
Mature & Immature	2	2	—	—	1	1
Both immature	—	—	1	2	1	—
Male mature & Female immature	—	—	4	3	—	—
Female mature & Male immature	—	—	1	—	—	—

TABLE 10. SEXUAL COMBINATIONS IN THREE FIN WHALES CAUGHT FROM THE SCHOOL OF FOUR FIN WHALES IN THE NORTH PACIFIC IN 1955 AND 1956

	1955	1956
Three males	—	1
Female & Two males	1	3
Two females & One male	1	—

TABLE 11. SEXUAL OCCURRENCES IN THE CATCH OF FIN WHALES FROM THE SCHOOL OF MANY FIN WHALES MORE THAN FIVE IN THE NORTH PACIFIC IN 1955

	2/5*	3/5	2/6	3/6	4/6	2/7	3/7	2/8	2/10	2/12	2/10-15	2/20**	2/50**
Number	13	3	7	3	1	2	1	2	4	1	1	1	1
Male & Male	5	—	3	—	—	—	—	1	—	—	—	1	—
Male & Female	6	—	4	—	—	1	—	1	3	1	—	—	1
Female & Female	2	—	—	—	—	1	—	—	1	—	1	—	—
Male & Two females	—	—	—	2	—	—	—	—	—	—	—	—	—
Three males	—	1	—	1	—	—	1	—	—	—	—	—	—
Two males & One Female	—	1	—	—	—	—	—	—	—	—	—	—	—
Three males & One female	—	—	—	—	1	—	—	—	—	—	—	—	—
Three females	—	1	—	—	—	—	—	—	—	—	—	—	—

* The lower shows the number of fin whales in a school and the upper shows number of whales caught.

** These schools are somewhat doubtful, possibly shoals of schools.

and there are seven pairs two males and two females respectively. The sexual conditions of those fin whales are as follows. Among the seven pairs of male and male, five cases are both mature and one mature in two cases. This may be affected by the size regulation for the catch as stated in the former part. In those groups, the pairs of mature male and immature female are more than the one of immature male and mature female in general, which is already pointed out in the case of two fin whales' school. Eleven pairs of males are sexually mature and two pairs are

composed of one mature male and another immature male in 1956. There are ten combinations of mature one male and another female fin whales, two combinations are sexually immature in both whales. Mature males and immature females form three cases but there is no case of immature male and mature female fin whales in 1956.

School composed of more than four

There is none of the record of the perfect catch of the school composed of more than four, but there are considerable number of the chasing for the school of many fin whales more than four. Two cases in 1955 and four ones in 1956 are found catching three fin whales from the school of four fin whales as illustrated in Table 10. It is very interesting to note that the males are dominant in the catch in spite of the size selection by catcher boats.

Especially the immature males are scarcely observed in those cases. If the size selection is effective for the catch of those fin whales, the number of female fin whales might be dominant. It is suggested the dominant catch of males show these school are composed of more males than females.

The example of the catch of fin whales from the schools of many fin whales is found in 1955. The occurrences of males and females are given in Table 11. Male fin whales are found more than female in general and if the size selection affect the catch it should be reverse to the facts. This tendency may confirm the general feature of schools of fin whales in the feeding grounds. In the land mammals, the socionomic sex ratio is high in females in their group and herd (Ito, 1959), the fact of which is the reverse to the fin whales.

It is interesting that the catch of immature males and females are observed from the comparatively large schools. Two fin whales are caught from the school of five fin whales in 1955, and both males are sexually immature. The body lengths are 53 and 50 feet and other fin whales in the same school are estimated as the same length. The catch of two fin whales from the school of five whales show those two females are immature, the body length of which are 58 and 59 feet respectively. These two cases show to some extent the young agers assemblage and sexual assemblage in fin whales as it is supposed up to this time.

Andrews also recognizes such assemblage in grey whales (Andrews, 1914). There have been sometimes found the school of fin whales more than ten, however, these schools may be the congregation of many schools especially in the feeding area to take the shoal of euphausiids. It is generally accepted the schools of many fin whales have been observed in their migration route to and from the feeding and breeding areas. Brown (1958) reports the greatest numbers of orquals observed by ships are about fifty and thirty in the north Atlantic.

BLUE WHALE (*BALAENOPTERA MUSCULUS*)

In the North Pacific, blue whales are ocean denizen and their main schools never penetrate into the Bering sea (Nemoto, 1959). The number of blue whales observed in the data is also small, and there still remains some question for the reliability of the samples.

Single swimming blue whales are dominant among the schools in the data, and thirty-six blue whales out of thirty-eight schools in 1955, and fifty-eight blue whales out of sixty-seven schools in 1956 are observed to be single in the feeding areas. In 1955, those single swimming blue whales are of more males than females and this is the same in 1956 too. Sexual maturity conditions are given in Table 12 but it is difficult to get any conclusion from the table because the number is rather limited.

The chasing and the catch are done for one school in 1955 and nine schools in 1956 which consist of two blue whales in a school. Two blue whales in a school are caught in 1955, one of which is male, sexually mature, and another is also male but it is considered it just attains sexual maturity. In 1955, two blue whales are

TABLE 12. SEXUAL CONDITIONS OF BLUE WHALES CAUGHT IN THE NORTH PACIFIC IN 1955 AND 1956

		Number of whales in a school			
		1		2	3
		Mature	Immature	Mature	Mature
1955	Male	22	4	2(2/2*)	2(2/3*)
	Female	7	3	—	—
1956	Male	28	2	8(1/2*)	—
	Female	21	7	1(1/2*)	—

* Upper shows the catch number and the lower shows the number of whales in a school.

caught from the three blue whales' school, which are sexually mature and just matured ones. I have nine cases of the capture that only one blue whale is caught from the two blue whales' school in 1956. All eight males are sexually mature and one sexually mature female blue whales is pregnant. It is suggested two blue whales' schools are composed of more males than female like the cases in 1955. But it is also considered the male sex ratio in single swimming blue whales is high, and the female blue whales swimming with calf escape the chasing by catcher boats.

The one reason that the number of blue whales in a school is rather small, is attributable to the relative abundance of blue whales in the North Pacific. Comparatively large schools of blue whales had been observed in the Antarctic in the former age of the whaling, when blue whales were dominant.

SEI WHALE (*BALAENOPTERA BOREALIS*)

There have been considerable differences among the annual catches of sei whales. The general tendency has not been obtained as for the school of sei whales, but three sei whales have been found in a school both in 1955 and 1956 as the maximum number. The school of six sei whales is reported in the previous report (Nemoto, 1959), however, the most common schools are up to three sei whales in a school. Generally speaking, the number of sei whales are comparatively small in a school comparing with other fin and humpback whales.

In 1955, ten males and nine females are caught from single swimming sei whales.

Four males and two females of them are sexually immature. But two immature sei whales have been caught from the school of two sei whales. Although the sample is rather scarce, it may be considered that immature sei whales sometimes swim alone to feed more often than the sexually mature sei whales. The sei whales caught in 1956 also show such tendency that the sexually mature whales form the school of two or more whales

The cases of two sei whales caught from two whales' school are observed both in 1955 and 1956. One case in 1955 and five cases in 1956 respectively. All sei whales are sexually mature and all females are pregnant, the compositions of which

TABLE 13. NUMBER OF SEI WHALES IN A SCHOOL CHASED BY CATCHER BOATS IN THE NORTH PACIFIC IN 1955 AND 1956

	Number of sei whales in a school		
	1	2	3
1955	19	11	2
1956	4	5	1

TABLE 14. SEXUAL COMBINATIONS IN SEI WHALES CAUGHT IN THE NORTH PACIFIC IN 1955 AND 1956 IN RELATION TO NUMBER IN THE SCHOOL

	2/2*			2/3*		3/3*
	M & M	M & F	F & F	M & M	M & F	M, F & F
1955	1	—	—	1	1 (Female pregnant)	—
1956	3	1 (Female pregnant)	1 (Both pregnant)	—	—	1 (Both females pregnant)

* Upper shows the number of sei whales caught from a school and the lower shows the number of whales in a school. M—Male, F—Female.

are given in Table 14. Although the number is rather small, the male pair is dominant among the schools, and there are one combination of male and female, and another of both females respectively. Three sei whales are caught from three whales' school in 1955. Two pregnant females and one sexually mature male are present in the school. There have been two cases of the catch of two sei whales from the school of three sei whales, and one is the pair of male and female sei whales, and two males are another.

Owing to the small number of the examples as repeated, there has been no clear tendency in the schooling of sei whales. It is suggested only that the two males' school is more than female combination in the school of two sei whales like the case in fin whales.

HUMPBACK WHALE (*MEGAPTERA NOVAEANGLIAE*)

The number of humpback whales caught in 1955 and 1956 is not so large as fin whales. In 1956, single swimming humpback whales are observed in nineteen cases and two humpback whales in a school eight cases. Three or more whales

found in a school are rather scarce, and humpback whales are observed up to seven in a school. The same tendencies are found in the data in 1955, when single humpback whales and schools composed of two humpback whales are dominant among them. Especially many pair humpback whales in a school are reported in 1955 as shown in Table 15.

TABLE 15. NUMBER OF HUMPBACK WHALES IN A SCHOOL IN THE NORTH PACIFIC IN 1955 AND 1956

	Number of whales in a school						
	1	2	3	4	5	6	7
1955	27	31	2	1	—	—	—
1956	19	8	1	1	1	—	1

TABLE 16. SEXUAL COMBINATIONS IN THE PAIR HUMPBACK WHALES IN THE NORTH PACIFIC IN 1955 AND 1956

	Sexual combination		
	Male & Male	Male & Female	Female & Female
1955	1	3	—
1956	1	1	1

TABLE 17. SEXUAL CONDITIONS OF HUMPBACK WHALES' SCHOOLS IN THE NORTH PACIFIC IN 1955 AND 1956

	1/1*				1/2*			
	1955		1956		1955		1956	
	Male	Female	Male	Female	Male	Female	Male	Female
Mature	10	8	7	5	7	6	1	2
Immature	—	9	2	5	—	4	1	1
(Pregnant)	—	(5)	—	(3)	—	(3)	—	—
Total	10	17	9	10	7	10	2	3

* Upper shows the number of whales caught and the lower shows the number of sei whales in a school.

TABLE 18. SEXUAL COMBINATIONS IN HUMPBACK WHALES IN THE NORTH PACIFIC IN 1955 AND 1956

	2/3*	2/4*	3/4*	2/5*	1/7*
Male	1	2	2	—	—
Female	1	—	1	2	1

* Upper shows the number of catch and the lower shows the number of whales in a school.

From the biological data collected on the whaling factory ships, comparatively many immature humpback whales have been found as the single swimming whale. The termination of two whales in a school is done in four cases in 1955 and three in 1956, the occurrences of each sex of which are given in Table 16. The pair of male and female is dominant among the schools although the school number is rather small. It is interesting the sexually immature male or female humpback whales are present in the pairs in five cases, and only two cases composed of sexually mature whales. This tendency has not been observed in other baleen whales.

The sexual conditions of one whale from the pair are illustrated in Table 17.

The catch of humpback whales from three or more party is far less compared with said cases. Three whales are caught from four humpback whales in a school in 1955 which composed of one resting mature female and one mature male and immature male. The occurrences of each sex in those catches from schools composed of three or more whales are given in Table 18.

The humpback whales in the breeding area seem not to form groups of many whales, Chittleborough (1953) describes only up to three adults in a school in the coasts of Australia, and Brown (1957:1958) describes that seven is the greatest number and other observations are all of single or very small parties in the north of the equator in the Indian ocean. About twelve whales are found in the coast of Australia in two of the four records in his report, however, the number of the observations on humpback whales in the area is rather scarce and these observations do not reliably sample the coastal areas of Australia as discussed by Brown. The sexual segregation in humpback whales in migration is very typical, and those results should be examined by further materials. In the breeding areas of the North Pacific, there is also very few data on the schools of humpback whales.

RIGHT WHALE (*EUBALAENA GLACIALIS*)

The observations, marking and biological research on right whales have been rather scarce both in the Antarctic and in the North Pacific. The observations on right whales in the North Pacific are given in Table 19. The single swimming right whale is dominant among the schools and four right whales is at most in a school. Japanese investigations on right whales have caught eleven right whales in recent years with special permission by government. And those right whales have been all single swimming right whales but one case, which consists of two right whales. When the one puberty female is caught (Kasuya, 1962. personal communication), it is said the another right whale comes back again after a little while and swims around the captured right whale.

TABLE 19. NUMBER OF RIGHT WHALES IN A SCHOOL
IN THE NORTH PACIFIC

		Number of whales in a school			
		1	2	3	4
1941-1957*	Coast of Japan	53	15	2	—
	North Pacific	58	30	4	2
1961-1963	North Pacific	21	8**	4	—

* Omura (1958).

** Including one cow and calf.

Other ten right whales consist of seven males and three females. Among seven males, three whales are sexually immature, and two females are also sexually immature out of four females. Two pregnant females are caught in 1963, when they are swimming as the single in the feeding areas in the North Pacific.

GREY WHALE (*ESCHRICHTIUS GLAUCUS*)

According to Gilmore (1958), grey whales are not a highly social animal, and the most commonly integrated social groups are the pair, and the trio. He considers the trio is made up usually a female and two males, and is also somewhat imparmanent. Scammon (in Andrews, 1914) writes also the case of the school, composed of a female, her calf and a male will go to the northward to the feeding. The observation of schools of grey whales are also found in the papers by Andrews (1914), Nasu (1960) and Pike (1962), which suggest the school of grey whales is sometimes containing many whales. As a important notice, the leadership by the female in the school of grey whales should be noted in relation to the land mammals such as deers. But the discussion by Andrews is a preliminary one, and these ecological points should be examined on more detail characteristics.

The available observations on the school of grey whales are rather few. In 1955, Japanese marking ship found grey whales feeding in the north-west sea of St. Lawrence Is. in Bering sea. In the descriptions, one to three groups of grey whales are mostly found. Two grey whales, 41 feet and 37 feet long are found in a school at 63-34N and 172-48W on 2th August. Other two pairs of grey whales, 40 and 36 feet, and 37 feet, and two trio (36 and 37 feet trio) are reported in the neighbouring waters and the most schools are single, pairs and trios.

In recent observations, Wilke and Fiscus (1961) describe eight grey whales in scattered pairs were seen moving toward narrow Kodiak and Ugak Is on 11th May in 1957, and two grey whales were seen from the 'John N. Cobb' feeding near 67-40N, 167-12W on 19th August in 1959, and on 20th Aug. three others are feeding. These observations confirm the comparatively small unit in schooling of grey whales in the feeding areas, although they sometimes form the huge congregations in the feeding areas in the narrow place.

DISCUSSION AND RESULT BY MARKING RESEARCH

The general observations on the school of whales chased in the marking research have been carried out in the North Pacific and the Antarctic, and the catch log on the recaptured marked whales usually refer the behaviour of the whales including other whales in the same school. From these materials, very interesting consideration on schools of baleen whales are deprived.

One of the most interesting example is found in the marking for the pair of cow and calf of fin whales in the North Pacific. In 1955, two cows with calves were marked on 18th July and 26th July. These adult females are caught in 1957, when they are feeding in the North Pacific solitary. Further, these two whales are pregnant. The patterns of the whales may be summerized as follows. In the summer of 1955, these two mother whales were feeding with their calves, and their calves were within two years after the birth, perhaps yearling, considering their body length (Ohsumi, Nishiwaki & Hibiya, 1958 : Laws, 1961). The larger calf might be feeding on the planktons with his mother, as the body length is about 46 feet which is estimated

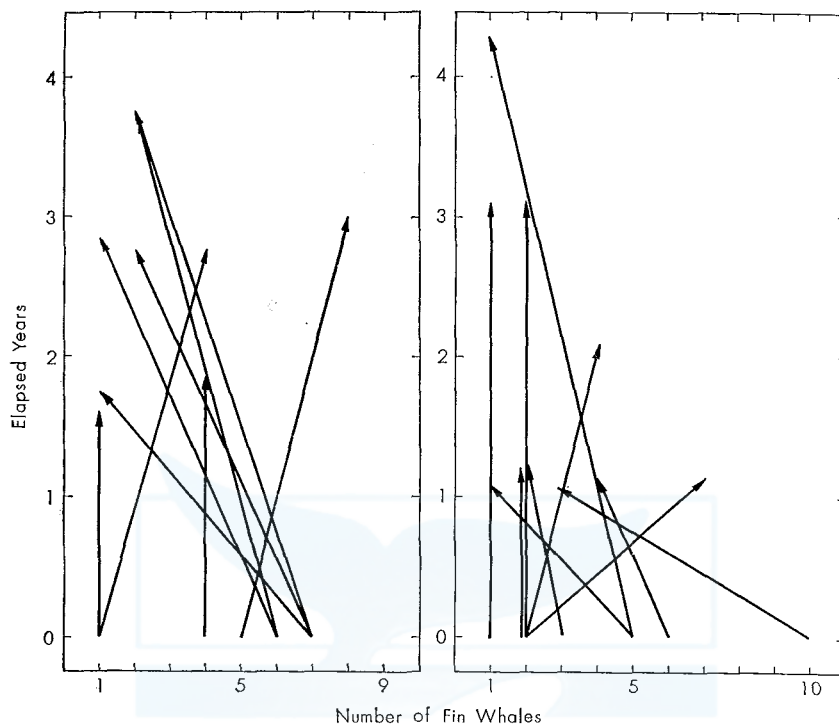

Fig. 3. Formation and separation in the number of whales in the school of fin whales in the Antarctic (Left) and North Pacific by the marking research.

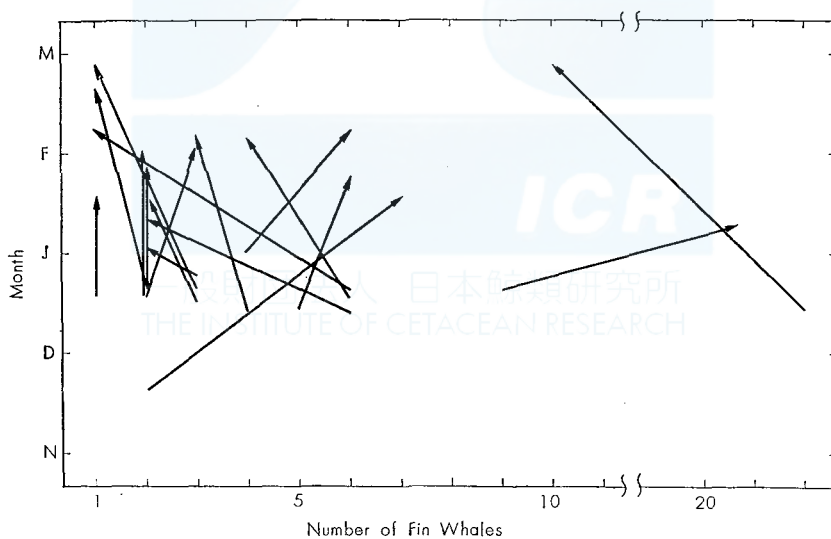

Fig. 4. Formation and separation in the school of fin whales in the Antarctic by the marking research. The marks are recovered within the summer Antarctic season of each case.

after the weaning. When the mother fin whales recaptured in the feeding areas in summer, they have five and nine months' fetuses calculated from the body length (Ohsumi, Nishiwaki & Hibiya, 1958). They must have copulated five and nine months in the late winter respectively. January and October are the possible breeding months for them and the grown calves might be free from the mother fin whales before the time of those copulations because there are few cases of the other whales joining in the pair of cow and calf schools. The fin whales separated with males after copulation between the fertilization and being caught.

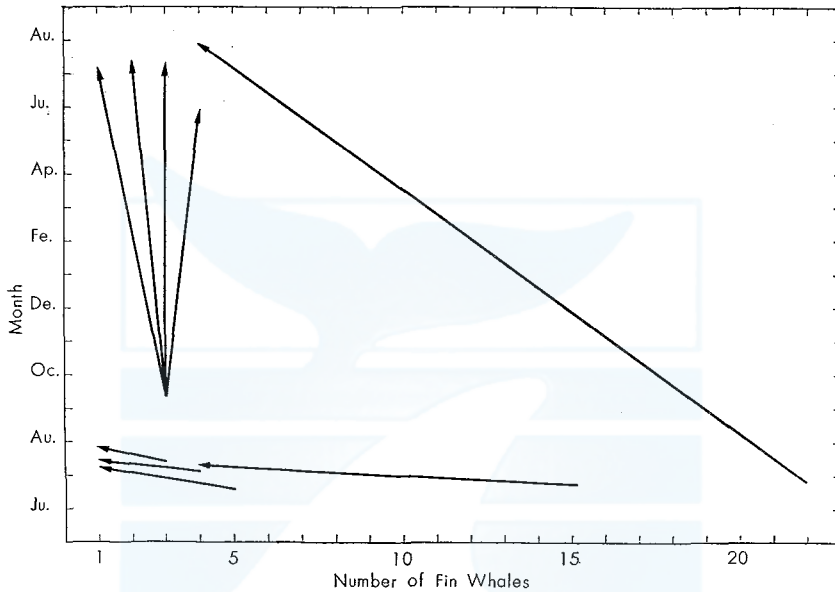

Fig. 5. Formation and separation in the number of whales in the school of fin whales in the North Pacific by the marking research. The marks are recovered within the season of each case.

The number of baleen whales in a school has been examined by the marking research too. As it is discussed in the former part, the single swimming fin whales are considered to decrease with the proceeding of the summer season in the observation of the catch log. But the marked fin whales in a school of many whales part with the parties, and they are found in the schools of smaller number. This would clearly show the breaking down of the school of fin whales in the feeding areas in the summer season too. Considering these two facts together, the school of fin whales may be inconstant in the feeding areas in the summer. It is not clear which is more important factor from the ecological point of view. The clear tendency to form the school of male and female pairs and some peculiar sex ratio should be considered again as one of the significant points in the school of fin whales in the feeding grounds.

If it is supposed that fin whales migrate south to breed, the formation of schools in the feeding areas may be very useful. On the other hand, the se-

peration of the sexually mature fin whales from the other younger whales in the school may break the school. It is considered to be natural that mutual affection is one reason to form or break the schools among the sexually mature fin whales. This type of the separation in the school of fin whales in the feeding grounds has been observed in the Antarctic too. The case of the formations in the school also have been observed, however, available examples are less than those of the separations.

To make up the gap of the above described results by the observations by catch log and the marking research, further accumulations of the materials are necessary. And it should be considered that the pregnant females, sometimes feeding alone in the feeding areas as discussed in the former part, leave the north sea feeding area earlier than other whales (Laws, 1959). The schools consist of many fin whales may separate and form each party by some reasons such as affections, and younger agers assemblage keep their schools still in the feeding grounds. These schools consist of comparatively many small whales are sometimes observed in the marking research in the North Pacific and the Antarctic.

The variation of the number of the whales in a school for a long time also has been checked by the marking the results of which are shown in Fig. 3, In these examinations, many schools of fin whales decrease the number of the party in the schools, but some schools have the participants, between the time being marked and caught.

Besides fin whales, the marking data on the schools of other baleen whales are rather scarce. In the North Pacific, a school of three blue whales is observed on 20th July and one of them, the marked whale, is found solitary after twelve days, on 24th July.

Five blue whales observed in a school in the Antarctic on 13th Dec. and they have six members in the next year, namely 22nd January, after the lapse of nineteen days. One of a pair of blue whales marked on 19th December in 1958 is caught on 8th February 1959 when the blue whale is swimming solitary.

There is one case of humpback whales in 1958. The pair of humpback whales marked on 25th December in the Antarctic and found in the next year in the same number pair of two on 1st February.

The ecological habit such as the forming or the breaking of schools must be connected with the very characteristic feeding migration in baleen whales. The solution of this origin and history may be one key to the problem (Marr, 1962).

SCHOOL OF DIFFERENT WHALE SPECIES

School of blue and fin whales

Sometimes baleen whales swim with different species of whales in the same school. Gunther (1949) describes the case of one blue whale swimming with four fin whales in a school in the Antarctic. From the data collected in the Antarctic from the year 1957 to 1958, it is reported five cases composed of blue and fin whales (Nemoto, 1959). In that paper, that the sexually immature blue whales swim with the sexual-

ly mature fin whales and the number of blue whales are always less than fin whales or the same number, is described. The followings discuss the problem chiefly according to the marking and the catch results.

School composed of fin and blue whales

There are eleven schools composed of fin and blue whales up to these days as given in Table 20, five of which were already reported in the previous paper (Nemoto, 1959). The number of blue whales are the same or less than fin whales, and the body length estimated by the crew of catcher boats shows the possible sexual immaturity as described by me. The school composed of less fin and more blue whales in number has not been observed in the records yet.

TABLE 20. THE OCCURRENCES OF THE SCHOOL COMPOSED OF FIN AND BLUE WHALES OBSERVED BY JAPANESE WHALE MARKING CRUISE IN THE ANTARCTIC FROM 1954 TO 1961

	Blue	Fin	Blue	Fin	Blue	Fin	Blue	Fin	Blue	Fin
Number of whales	1	1	1	1	1	2	1	2	1	3
Estimated body length in feet	62	71	70	68	73	60-63	78	?	72	63-65
Total number of whales in a school	2		2		3		3		4	
Number of whales	Blue	Fin	Blue	Fin	Blue	Fin	Blue	Fin	Blue	Fin
	1	4	1	4	1	5	2	4	2	6
Estimated body length in feet	?	?	80	65-67	70	65-70	73	64-65	?	50-65
Total number of whales in a school	5		5		6		6		8	
	Blue	Fin	Blue	Fin	Blue	Fin	Blue	Fin	Blue	Fin
	2	Ca 10	2	Ca 10	2	Ca 10	2	Ca 10	2	Ca 10
Estimated body length in feet	60	70	60	70	60	70	60	70	60	70
Total number of whales in a school	Ca 12		Ca 12		Ca 12		Ca 12		Ca 12	

TABLE 21. THE OCCURRENCES OF THE SCHOOL COMPOSED OF FIN AND SEI WHALES IN THE FEEDING GROUNDS

	Antarctic		North Pacific		North Pacific	
	Fin	Sei	Fin	Sei	Fin	Sei
Number of whales	2	2	2	4	1	2
Estimated length of whales in feet	60	45	56-57	45-48	58	?
Total number of whales in a school	4		6		3	

School of fin and sei whales

There have been three cases of fin whales swim with sei whales in the records. In 1960, a school of two fin and two sei whales is observed in 56-32 S, 77-06W in the Antarctic, and two cases observed in the North Pacific. The latter cases are composed of two fin and four sei whales in one and one fin and two sei whales in another case. The body sizes of fin whales are comparatively small, and they are estimated to be sexually immature or just matured. On the contrary to this, the body length of sei whales are large and possibly sexually mature. I would consider this is the same tendency with the case of blue and fin whales and that the larger baleen whales sometimes swim with the different smaller species of baleen whales in the case that they are sexually immature and the number is the same or the less. The sexual potentiality may be the one reason to join a school

of different baleen whales in the feeding areas. This tendency is considered common in *Balaenoptera* whales both in the Antarctic and the North Pacific.

School of sei and bryde's whales

A school of sei and bryde's whales is observed in the adjacent waters to Japan in 1961. About 180 miles from Kinkazan, the north-east part of the Pacific coast of Japan, one mature male bryde's whale, testis of which are both 1.6 kg, is found swimming with a immature sei whale and those two whales are caught by catcher boat.

School of fin and little piked whales

A little piked whale (*Balaenoptera acutorostrata*) is observed in a school of fin whales on 13th Dec. in 1959, 59-17S, 82-52W in the Antarctic. But it may be accepted that the little piked whale only follows the school of fin whales a little while.

There has been no record of the school composed of *Balaenoptera* and *Megaptera* whales. Sometimes it is observed that humpback whales feed with *Balaenoptera* whales in the same feeding areas in the very near place and seem to be in the same school, but they are split into respective species after a while by the chasing. The swimming speed and the general diving depth may have the relation with the formation of schools in the case. And frequent turning in humpback whales is also one reason of the separation too.

Mackintosh (1942) and others (Matthews, 1938; Nemoto, 1959; 1962b) point out that the peculiar migrating time to the feeding areas and segregation in the distribution in the feeding areas both in the southern and the northern waters is observed in each baleen whale species. One example in the North Pacific is shown in Fig. 6. There are differences among the distributions of baleen whales according to species, and the primary preferences of their foods is considered as the first reason for their distributions. Blue whales feed only on euphausiids, and sei whales prefer copepods especially *Calanus plumchrus*, but they rarely take *Calanus cristatus* in these waters (Nemoto, 1959). Fin whales feed on euphausiids as well as copepoda, *Calanus cristatus*, but they rarely take *Calanus plumchrus* (Nemoto, 1959).

These selections of foods and different oceanographic conditions for each food species may form such distributions, however, the feeding range in each species of baleen whales and the occupation is considered if it is fixed within a certain time. Thus the two types of ecological segregations (Miyaji & Mori, 1953) are recognized in these distributions. In the previous report (Nemoto, 1959), I suggest the possible biological strength, numbers and migration time between two baleen whales cause some segregations in the feeding grounds. The case that the habit of feeding is affected also by the number of each species is pointed out by Elton on the land animal Buffalo (*Bos caffer*) in Africa (Elton, 1927).

These types of the segregations in the feeding grounds have been observed between blue and fin whales, fin and sei whales. In recent years, the distributions of fin whales become different from the former days, and sei whales also penetrate into the Antarctic high latitudes and waters of pack ice. This is partly attributed

able to the numbers of individuals and biological strength among baleen whales as suggested by Nemoto (1959). These biological strength may be confirmed by the presence of the school of different species as discussed in the former part.

There is another explanation for the fact that the different species baleen whales of the same size may sometimes swim together in the feeding grounds. But considering the number of baleen whales in a school, that the larger whales are usually less than the smaller species, the former is more suitable explanation for the problem.

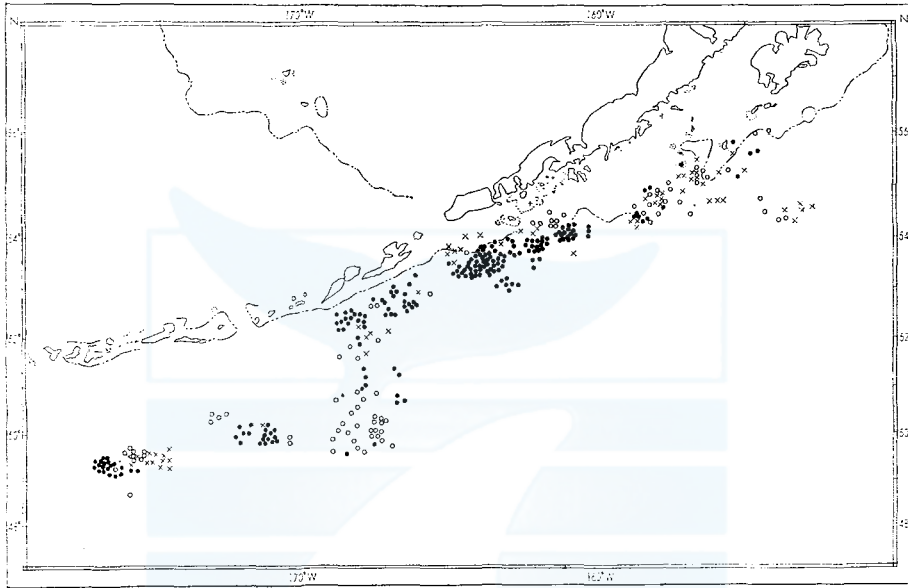

Fig. 6. Distributions of baleen whales in the North Pacific in July in 1960, showing the different patterns in distributions of baleen whales by species. Open circle—Fin whales: Black circle—sei whales: Cross—Blue whales.

COW AND CALF PAIR

It seems rather rare that the pair of cow and calf swims with other whales even in the same species. Gunther (1949) describes a case that a cow and a calf swim with other whales but it is only one case in his report. Slijper (1958) also states the maintenance of the family in blue and right whales, however, the sources of which are not indicated.

Both in the Antarctic and North Pacific, the cases that the pair of cow and calf is found with other whales are rather scarce as illustrated in Table 22. But in humpback whales, the calves sometimes are accompanied not only by their mother whales but also other adults (Chittleborough, 1953).

In the *Balaenoptera* whales, only females give protections to their calves after their parturition. The new born calves in *Balaenoptera* whales can swim perfectly with their mother but the family of *Balaenoptera* whales consists only of females and

their calves in general. Those pregnant whales in feeding grounds might migrate to the south single or with other whales but they will be alone after their parturition.

Chittleborough (1953) observes two cases of cow and calf pairs of fin whales but no other whale in them in the waters off Australia in the lower latitudes.

TABLE 22. THE SCHOOL OF COW AND CALF PAIR AND OTHER WHALES FOUND WITH THE PAIR IN THE FEEDING GROUNDS

	Number of Cow & calf	Number of other whales with the pair						
		+1	+2	+3	+4	+5	+6	+9
Antarctic								
Blue whales	6	—	—	—	—	—	—	—
Fin whales	14	1	—	—	—	—	1	—
Humpback whales	9	4	1	2	—	1	—	1
North Pacific								
Blue whales	3	—	—	—	—	—	—	—
Fin whales	16	1	—	—	—	—	1	—
Sei whales	2	1	1	—	—	—	—	—
Humpback whales	9	1	—	1	—	—	—	—
Bryde's whales	8	—	—	—	—	—	—	—

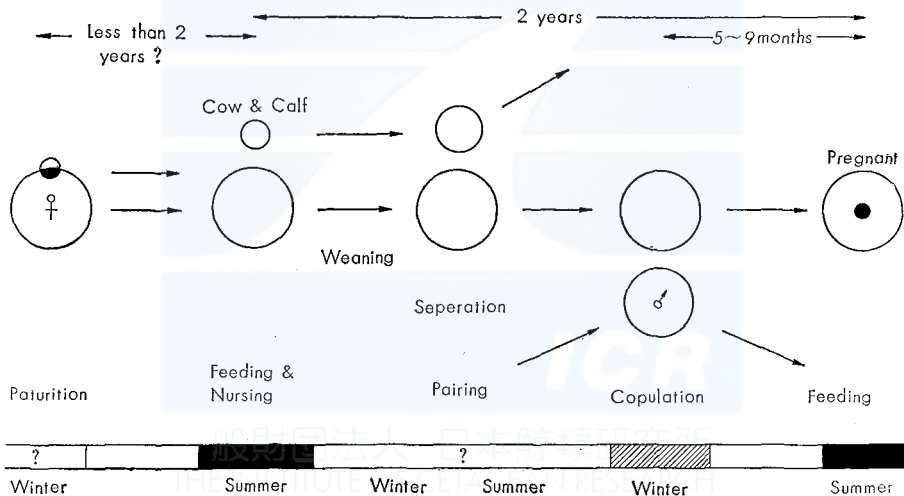

Fig. 7 Schema of the cycle of cow and calf fin whales in the North Pacific by the marking research. The marks were hit in 1955 and recovered in 1957 both in summer seasons.

The pair of cow and calf in humpback whales sometimes swims with other adult whales. This tendency is given in Table 22 too. Chittleborough (1953) also describes that a calf usually accompanies a single adults, but sometimes two adults were present. This confirms the results in the Antarctic area in Table 22. If the starting of the pair of cow and calf to the south only by themselves, the formation of the school may be done in the route or in the feeding areas where the range in

the distribution is rather small and they may contact with each other more often than other baleen whales. The companionship is built in their migration and feeding, however, the sex of the members are still unknown.

The pair of cow and calf have been observed in a considerable number in the feeding areas. But it is very rare to be found with other whales besides the family. Namely cow and calf form the family by themselves. The nursing duration is about seven in fin whales, and fin whales usually do not form the school of many whales with the family within it, as a conclusion.

It is clear from above facts, that *Balaenoptera* baleen whales do not accept the family (cow and calf) in their school although the calf of *Balaenoptera* is able to swim with their mother and adults.

SUMMARY

The preliminary consideration on the school of baleen whales in the feeding areas are made based on the Antarctic and the North Pacific baleen whales caught by the Japanese whaling and the whale marking data. The important points are as follows.

1. The number of baleen whales in a school is examined on fin, blue, sei, hump-back, right and grey whales. The seasonal change in the number of fin whales in a school is suggested.

2. The sex ratio and sexual combinations are studied on the school of baleen whales especially in fin whales. From the catch of the pair fin whales, the combination of male and male, and male and female fin whales are more than the one of both females. The sexual combinations of members of the trio and other schools of fin whales are also investigated.

3. Based on the marking research, the following up to the number of baleen whales in a school is done both in the Antarctic and in the North Pacific. The number of fin whales in a school varies and the breaking up of the school is observed in the feeding grounds. Two pregnant fin whales are caught which had been marked when they swam with calves, and they are feeding solitary, suggesting one type of the formation and separation of breaking the school in fin whales.

4. The peculiar feature of the school of different species of baleen whales are described. These schools are observed in fin and blue whales, fin and sei whales, and sei and bryde's whales. Among these combinations, the larger species of whales are the same or less in number than the smaller baleen whales in a school. The estimated body lengths of the blue whales in the school of fin and blue whales are comparatively short, and fin whales also small in the school of fin and sei whales and the possible reason, sexual potentiality, is suggested for the combination of different whale species.

5. The family of fin whales, cow and calf, is examined. It seems that the fin whales do not accept the family (cow and calf) into the school, and this tendency may be generally observed in *Balaenoptera* baleen whales.

REFERENCES

- ANDREWS, L.C. (1914). Monographs of the Pacific cetacea. 1, The California gray whale (*Rhachianectes glaucus* Cope). *Mem. Amer. Mus. Nat. Hist.*, N.S. 1(5): 231-84. 9pls.
- BROWN, S.G. (1957). Whales observed in the Indian Ocean. Noted on their distribution. *Marine Obs.*, London, 27: 157-65.
- (1958). Whales observed in the Aitlantic Ocean. *Marine Obs.*, 28(181) & (182): 142-6, 209-16.
- CHITTLEBOROUGH, R.G. (1953). Aerial observations on the humpback whale *Megaptera nodosa* (Bonnaterre), with notes on other species. *Aust. J. Mar. Freshw. Res.*, 4(2): 219-26. 2pls.
- CLARKE, R. (1962). Whale observation and marking off the coast of Chile in 1958 and from Ecuador towards and beyond the Galapagos Islands in 1959. *Norsk Hvalfangst-Tid.* 51(7): 265-87.
- CLARKE, R. & RUUD, J.T. (1954). International co-operation in Antarctic whale marking the voyage of the Enarn to the Antractic 1953. *Norsk Hvalfangst-Tid.* 43(3): 128-46.
- ELTON, C. (1927). *Animal ecology*. London
- FUJINO, K. (1960). Immunogenetic and marking approaches to identifying subpopulations of the north Pacific whales. *Sci. Rep. Whales Res. Inst.*, 15: 85-142.
- GILMORE, R.M. (1958). *The story of the gray whale*.
- GUNTHER, E.H. (1949). The habits of fin whales. *Discovery Rep.*, 25: 113-42.
- IMANISHI, K. (1951). *Ningen izen no Shakai*. [Society before the man.] Tokyo.
- (1959). *Dobutsu no Shakai to Kotai*. [Society and individual in animals.] Tokyo.
- ITO, Y. (1959). *Hikaku Seitaiigaku*. [Comparative ecology.] Tokyo.
- LAWS, R.M. (1959). The foetal growth rates of whales with special reference to the fin whales, *Balaenoptera physalus* Linn. *Discovery Rep.*, 29: 281-308. 1pl.
- (1961). Reproduction, growth and age of southern fin whales. *Discovery Rep.*, 31: 327-486. 4pls.
- MACKINTOSH, N.A. (1942). The southern stock of whalebone whales. *Discovery Rep.*, 9: 67-158.
- MARR, J.W.S. (1962). The natural history and geography of the Antarctic krill (*Euphausia superba* Dana). *Discovery Rep.*, 32: 33-464. 1pls.
- MATTHEWS, L.H. (1938). The sei whale, *Balaenoptera borealis*. *Discovery Rep.*, 17: 183-290. 2pls.
- MIYAJI, D. & Mori, K. (1953). *Dobutsu Seitaiigaku*. [The animal ecology.] Tokyo.
- NEMOTO, T. (1959). Food of baleen whales with reference to whale movements. *Sci. Rep. Whales Res. Inst.*, 14: 149-290. 1pl.
- (1962a). A secondary sexual character of fin whales. *Sci. Rep. Whales Res. Inst.*, 16: 29-34. 1pl.
- (1962b). Food of baleen whales collected in recent Japanese Antarctic whaling expeditions. *Sci. Rep. Whales Res. Inst.*, 16: 89-103.
- OHSUMI, S., NISHIWAKI M. & HIBIYA, K. (1957). Growth of fin whales in the northern Pacific. *Sci. Rep. Whales Res. Inst.*, 13: 97-134.
- PIKE, G.C. (1962). Migration and feeding of the grey whale (*Eschrichtius gibbosus*). *J. Fish. Res. Bd. Canada*, 19(5): 815-38.
- SLIJPER, E.J. (1958). Das Verhalten der Wale (Cetacea). *Handbuch der Zoologie*. 8Bd. 15 Lief., 14 Teil, 14 Beit., 1-32.
- WILKE, F. & FISCUS, C.H. (1961). Gray whale observation. *J. Mamm.*, 42(1): 108-9.

SQUIDS AS THE FOOD OF SPERM WHALES IN THE BERING SEA AND ALASKAN GULF

TAKASHI OKUTANI* AND TAKAHISA NEMOTO

It is well known that sperm whales, *Physeter catodon* (Linnaeus), feed on squids in the world seas. There are many reports on the feeding of sperm whale and squids found in the stomach of that whale (Mathews, 1938: Mizue, 1950: Clarke, 1955: Betesheva & Akimushikin, 1955: Clarke, 1962). Betesheva & Akimushikin (1955) described the food species of sperm whales in the waters of Kurile Island, and Pike (1950) and Rice (1963) reported the food animals of whales in the west coast of America.

The pelagic whaling by Japan and U.S.S.R. have been operating in the Aleutian waters and Bering Sea, and sperm whale is one of the important species of the catch therefrom. However, the foods of the sperm whales caught in the northern North Pacific have seldom been examined, although a report on the stones and other aliens found in the stomachs of the whales was published by Nemoto and Nasu (1962).

The stomach contents of the sperm whales from the waters around Aleutian Islands, Bering Sea and Alaskan Gulf were collected in 1963. These specimens were examined taxonomically, and their occurrences were studied in viewpoint of distributions of the squids and the predators in the north Pacific. Here this report deals with the preliminary results of the investigation, and this study will be continued to contribute the knowledge on distribution and taxonomy of squids in the North Pacific.

MATERIALS

The present samples were collected through the survey carried out in the North Pacific on board the factory ship. This investigation is mainly carried out in the waters around Aleutian Is., Alaskan Gulf and the Bering Sea. The field observations are made on all sperm whales caught, and the contents of stomachs are discriminated as squids, fish and other items. The observation was made on the first stomach content which is in fairly better condition than that elsewhere. However, sometimes second stomach was erroneously dissected for examination. The content found in the first stomach in worse condition might be the second stomach content surged back into the first. The squids have been preserved in 10% formalin sea water, and they are tentatively classified into types A,B,C,D,E and G. A part of samples taken out from the whale stomach was brought home for close examination.

* Tokai Regional Fisheries Research Laboratory, Tokyo.

SYNOPSIS OF THE SPECIES IDENTIFIED

As was mentioned in the preceding section, at the field observation six forms discriminated were classified into A, B, C, D, E and G. On the basis of the samples brought home, each group was found to be composed of the species as follows:

- A: *Moroteuthis robustus* (Verrill, 1876)
 B & D: *Gonatopsis borealis* Sasaki, 1923, *makko*, n. subsp.
 C: *Mastigoteuthis* (?) sp.
 Stigmatoteuthis sp.
 Galiteuthis armata Joubin, 1898
 Taonius pavo (Lesueur, 1821)
 E: *Gonatus* (*Berryteuthis*) *magister* Berry, 1913
 G: *Gonatus fabricii* (Lichtenstein, 1818)

Only C-Group was found containing four species. This is because these species have gelatinous integuments which are easily mutilated badly when taken by the predators. Sometime fragments of transparent pens of some unidentified Cranchiids were remained undigested.

Synoptic notes on the results of examination on the specimens are present in the following lines.

OEGOPSIDA

Onychoteuthidae

Moroteuthis robustus Verrill, 1876

Because of huge size, reddish variegation and rippled skin, this species is easily discriminated at the field observation on board the factory ship. One of the specimens brought home was measured about 700 mm in dorsal mantle length. Both tentacles were removed, but other characteristics are quite agreeable to the description by Sasaki (1929). Another specimen of head-foot part (mantle and visceral parts lacking) is much larger than the other, and the tentacular club is well preserved as is illustrated in Fig. 1 a. The specimens examined for the present study are generally gigantic in size, but a unique example of 300 mm-individual was found in the course of field observation. (see p. 118.)

Histiototeuthidae

Stigmatoteuthis species

A badly mutilated specimen was examined. The mantle length measured 100 mm and the longest arm, 300 mm. A part of the integument with some photophores is preserved. But identification to the species cannot be made because of lack of tentacle.

Gonatidae

Gonatus (s.s.) *fabricii* (Lichtenstein, 1818)

A single specimen brought home presented a very large size: Dorsal mantle length, 300 mm; width of the mantle, 56 mm; length of the fin, 170 mm; width of the fin taken together, 150 mm.

Mantle is robust, purplish in color in preserved state, elongated cylindrical and length is about five times diameter. The fins are muscular and rhomboidal in outline. They seem to present more elongated shape than those of younger specimens taken from the North Pacific on other occasions. Arms have two series of hooks on inner rows and two series of small suckers on outer rows. Arm formula is 3, 1, 2, 4.

The distal parts of both tentacles which may be the most important key of identification, were already lost when the specimen was taken out from the whale stomach. However, rows of small fixing pads disposed on both margins of sucker-bearing face of the tentacular carpus were observed. These rows of pads in *G. fabricii* reached far proximally than those in the next species. From such character and shapes of locking cartilages led the present authors to the conclusive identification of the present specimen.

Gonatus (Berryteuthis) magister Berry, 1913

Specimens examined are mostly adults measured about 200–250 mm in dorsal mantle length. They are seldom found broken into the body and head-foot parts, as their locking apparatuses may be fairly tighter than those of other species.

This species is readily identified by muscular and broad fin and moderately squat body. At a glance, it may be taken as Ommastrephids, if four-series of brachial armatures and peculiar tentacular armatures are overlooked.

Nothing could be added to the careful descriptions by Berry (1912 as a part of *G. fabricii*; 1913, an amendment of the name) and Sasaki (1929).

Gonatopsis borealis Sasaki, 1923 *makko**, n. subsp.

Oegopsida of moderate size; integument soft in touch and smooth all over. Mantle loligiform, soft, subcylindrical, tapering gradually posteriorly to an acutely attenuated point; anterior margin truncated, projecting very slightly at the mid-dorsum, broadly emarginated ventrally leaving rounded lateral angles on both sides of the funnel; the widest part of the mantle about one-third the dorsal mantle length. No sculptures and color patterns present externally but dark violet internally (in preserved state).

Fins muscular but rather soft with thinned margins, one-thirds as long as the dorsal mantle length, subrhomboidal, length equal to the width of both fins taken together, obtusely angulated at three-tenths posterior from the anterior margin.

Head as broad as the mantle opening. Neck moderately constricted, probably marginated by a circum-nuchal ridge, which is indistinct in the type specimen. Nuchal locking cartilage elongated rectangular with rounded corners, feebly narrowed at the middle, width a quarter long. Funnel excavation demarked by depressed nuchal folds on both sides. Funnel moderate in size, semilunar valve presents inside. Dorsal funnel organ V-shaped, the posterior tips of rami reach as far as the anus. Ventral organs small and ovoid. Funnel locking cartilage lanceolate, slightly curved, tapering anteriorly and widened posteriorly and then

* The subspecific name, *makko*, means sperm whale in Japanese.

rapidly narrowed to an angulated posterior end; groove very shallow, widened posteriorly ending an open end. Mantle locking cartilage very weak and ridge-like in shape.

Arms robust, very powerful in appearance; the ventral pair decidedly shorter than the others and as long as two-thirds the longest arm; the arm formula 2, 3, 1, 4; the longest arm attains two-thirds the dorsal mantle length. All of the arms nearly the same strength, gradually tapering distally; the sucker-bearing faces flat meeting with the side faces in a rectangle; the aboral side roundish. Integumental keel poorly developed on the third lateral arms. Web not well developed except at the proximal portion of the ventral arm. Armatures of arms composed of hooks and suckers. In the ventral pair, they present only suckers with several teeth at the distal margin of the horny rings. In other pairs of arms, the proximal several rows are loosely arranged suckers, there followed about thirty transverse rows of two small suckers outer side and two large hooks of inner side each. The outer suckers are borne on the thick and long pedicels and bear horny rings with few triangular teeth at the distal margin. The inner hooks are very sharp with vestigial sucker-like structure proximally. Tentacle completely absent. Buccal membrane papillated and dark violet in color (in preserved state) with seven projections on the margin, each suspended by long rib.

Gladius slenderly penniform, about one-fifteenth as broad as long.

Radulae not examined.

*Types**: Holotype, male, found from the stomach of a sperm whale; the integument is somewhat matilated probably by action of digestive fluid of the whale. Dimensions of the type specimen are as follows: dorsal mantle length, 350 mm; width of the mantle, 55 mm; length of the fin, 100 mm, width of the fin taken together, 100 mm; length of the dorsal arm (right), 200 mm; second lateral arm (right), 210 mm; third lateral arm (right), 225 mm; ventral arm (right), 170 mm.

Another specimen (paratype) with the dorsal mantle length 300 mm long is also matilated and separated into two parts. The third specimen (catch number 39: 52°26N, 175°11E) was only head-foot part remained and was the largest of all. The longest arm measured 300 mm in length and the arm formula was 2, 1=3, 4.

Remarks: At a glance, the present new subspecies is very similar to the typical *Gonatopsis borealis* Sasaki which is abundant in the northern North Pacific. However, some external morphological characteristics do not coincide with those of *G. borealis*, unless *G. borealis* presents a remarkable individual changes in proportion of various parts of the body.

An abridged comparison of those two types are as follows:

	typical <i>borealis</i>	<i>makko</i> , n. subsp.
General shape of the mantle	Cylindrical, somewhat squat; skin thick	Cylindrical, very slender; skin thin
Fin length	$\frac{2}{3}$ total breadth or $\frac{2}{5}$ mantle length	The same as the total breadth or $\frac{2}{3}$ mantle length

* Deposited in the National Science Museum, Tokyo, Reg. Nos: Mo. 13311 (Holotype), Mo. 13312 (Paratype).

Nuchal locking cartilage	Panduliform, with a gentle constriction near the middle	Elongated rectangular
Funnel locking cartilage	Panduliform, 1/3 as broad as long	Curved lanceolate, 1/4 as broad as long
Arm	2/5 the mantle length 3, 1=2=4	2/3 the mantle length 2, 3 (=) 1, 4

The criteria common to both forms are armature of arms which composed of four series of suckers and hooks all the way through and the sagittate outline of the fins. In contrast to these, another known *Gonatopsis*, *G. octopoda* Sasaki has 8-12 series of small suckers on the distal parts of the arms and a reiniform fins. *Distribution*: Probably a bathyelic zone of the northern North Pacific.

Mastigoteuthidae

Mastigoteuthis (?) sp.

A single strange specimens in a half digested state is taken to be a Mastigoteuthid. The specimen has degenerated tentacles which present only muscular short appendages between the third lateral and ventral arms. Degeneration of tentacles are hitherto known on *Gonatopsis* (Gonatidae) and *Octopodoteuthis* (Octopodoteuthidae) and none on any other families. Therefore, it is still inconclusive whether the present specimen belongs to Mastigoteuthidae.

Cranchiidae

Taonius pavo (Lesueur, 1821)

Galiteuthis armata (Joubin, 1898)

Two above-mentioned Cranchiids were found mixed with the preceding species and *Stigmatoteuthis* sp. As they have very delicate and gelatinous integuments, they are found to be completely destroyed.

DISTRIBUTIONAL IMPLICATION

The catch of sperm whales have been concentrated to the coastal waters of the Aleutian Is., the Bering Sea and Alaskan Gulf. This is corroborated by Clarke (1956) who described that sperm whales congregate to the neighborhood of the islands in the mid oceans and continental shelves. The distributions of sperm whales and their foods are illustrated in Figs. 1 and 2 based on the results in 1960 and 1963, respectively.

The male whales occupy the major part of the catch, and very small number of females were caught as are so for the Antarctic catch of sperm whales. Matthews (1938) suggests the difference in food between the male and female is possibly present as the males are usually large in size and more powerful in catching preys by deep sea diving. But no clear difference between the size of food squids intaken by male and female has been proved. (Matthews, 1938 : Clarke, 1956).

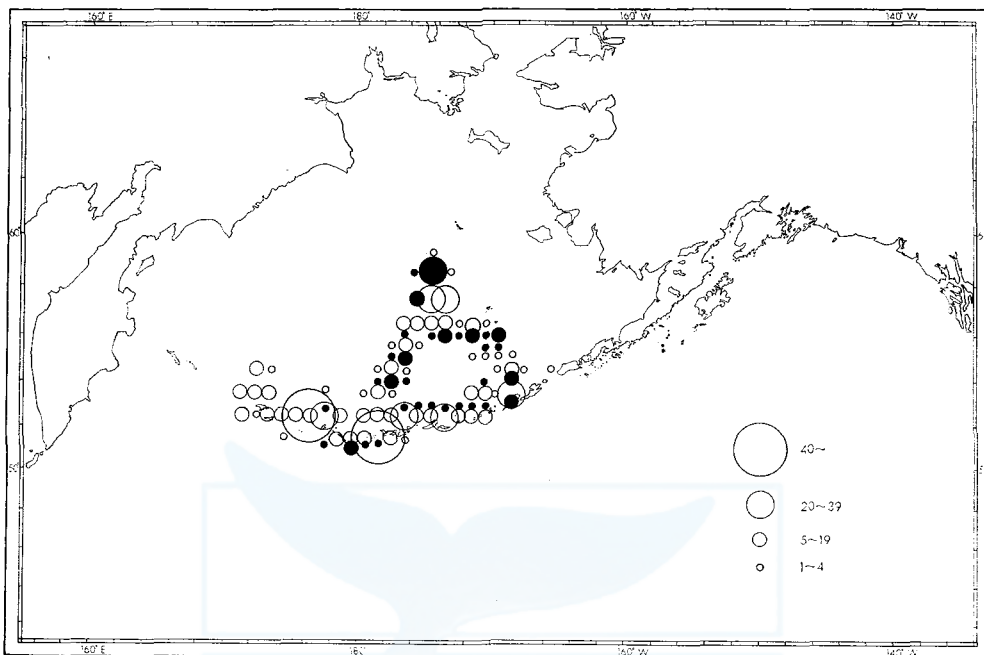

Fig. 1. Distribution of squids and fish in the stomachs of sperm whales from the Bering Sea, 1960. White—Squids, Black—Fish.

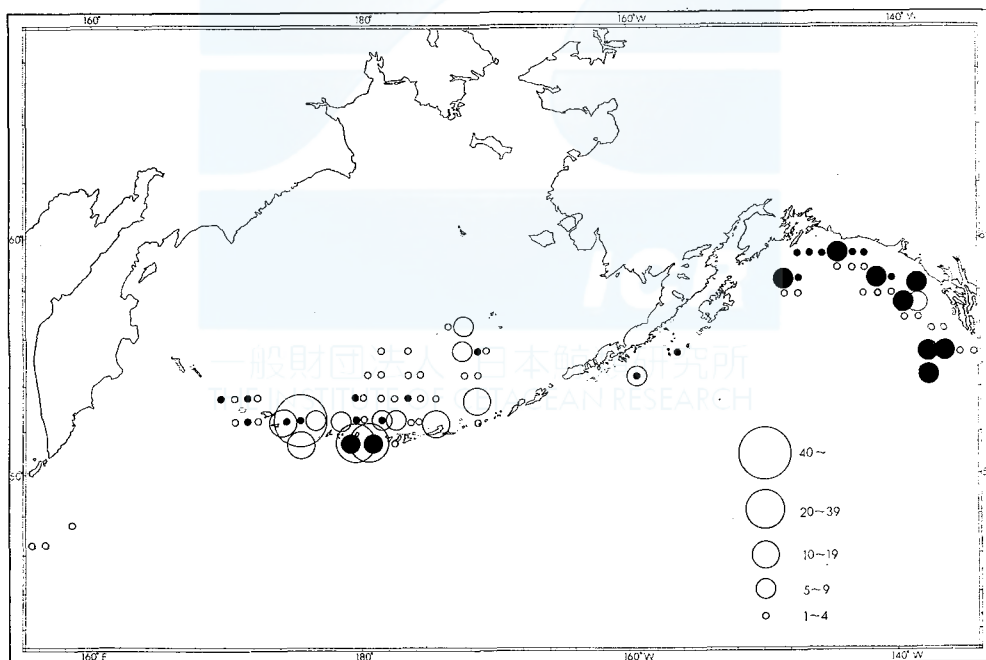

Fig. 2. Distribution of squids and fish in the stomachs of sperm whales from the Bering Sea and the Alaskan Gulf, 1963. White—Squids, Black—Fish.

It is evident from the Figs. 1 and 2, squids dominantly occur in the western part of the coastal waters around the Aleutian Is. Fish as the food of the whale are, on the contrary, mostly predominate in the eastern waters along the Alaskan Gulf and the east Bering Sea. This tendency was also noticed by Ohsumi (personal communication, 1956) for the Bering Sea. In 1960, the dominant occurrences of squids were observed in the waters around 176°E longitude and fish are mostly found in the northern area of the Bering Sea.

The 1963 catch of sperm whales was taken from the Alaskan Gulf where the sperm whales feed on fish in larger quantity than squids. For the foods of sperm whales in the other parts of the North Pacific Ocean, there are some reports available:

Mizue (1950) described squids and fish as the foods of sperm whales in the adjacent waters to Japan without classifying them. Betesheve & Akimushkin (1955) described foods of sperm whales from the Kurile waters. The foods species of sperm whales in the east Pacific along the American coast were described by Rice (1963).

TABLE 1. OCCURRENCES OF SQUIDS AND FISH IN THE STOMACHS OF SPERM WHALES FROM THE NORTHERN PART OF THE NORTH PACIFIC, 1960 AND 1963

		Bering Sea & Aleutian coast -180°	Bering Sea & Aleutian coast 180°-160°W	Coast of Alaskan Gulf 160°W-130°W
1960	{ Squids	240	434	—
	{ Fish	16	178	—
1963	{ Squids	129	116	45
	{ Fish	19	9	94

According to Betesheva & Akimushkin (1955) and Sleptozov (1955), the most important species of squids as the food of sperm whales are *Gonatus magister* and *Gonatus* sp. followed by *Gonatus fabricii*, *Galiteuthis armata*, *Taonius pavo*, *Chiroteuthis veranyi* and *Meleagrotheuthis seperata*. They presented few occurrences of giant squids, *Moroteuthis robustus* and *Architeuthis japonica*, from the Kurile waters. On the other hand, *Moroteuthis robustus* occupied 41% of the total food of sperm whales caught off America (Rice, 1962), although the materials are rather poor. *Gonatopsis borealis* stood the second rank of the foods reported by him.

From the materials treated here, the following patterns of distributions by species are observed:

Type A: *Moroteuthis robustus*

This was the most important squid in the waters around Aleutian Is. and the occurrences of this species are illustrated in Fig. 3. *Moroteuthis robustus* was found in the coastal areas of Alaskan Gulf as far as the Canadian coast. This squid was reported to be found from the stomachs of sperm whales taken off the west coast of British Columbia (Pike, 1950; Robbins, Oldham & Geiling, 1937). These observations suggest that *M. robustus* is also common in the California Current area.

There was found no diurnal change in occurrences as is shown in Fig. 5. Matsushita (1955) stated that the sperm whales in the Antarctic feed on squids in the early or the late hours of the day when those squids come up to the surface of the sea. Thus, whales need not to dive so deep in the sea to feed on large squids. At feeding, sperm whales in the Bering Sea may reach at the sea bottom sometimes, as some stones and other sedimentary aliens are found in the stomachs of sperm whales caught there (Nemoto, & Nasu, 1962). But, the ocean depths are generally not so large there as in the Antarctic waters.—The coastal waters of the Aleutian Is. are shallow enough for sperm whales to reach at the bottom, so that *Moroteuthis robustus* may be fed by them even in the mid-day at or near the bottom.

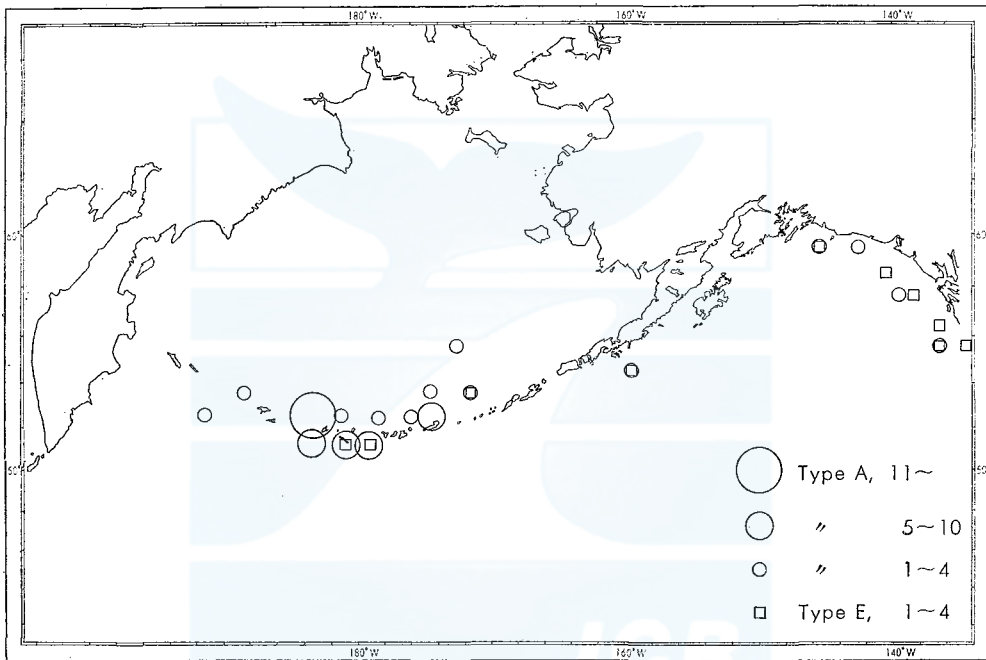

Fig. 3. Distribution of squids found in the stomachs of sperm whales from the Bering Sea and the Alaskan Gulf: Type A (*Moroteuthis robustus*) and Type E (*Gonatus magister*).

The specimens of *M. robustus* reported by Betesheva & Akimushkin (1955) were mostly ranging in size from 100 cm to 140 cm in total length including the foot. The largest one reported by Pike (1950) and Robbins, Oldham and Geiling (1937) measured 250 cm in length. In the present study, the large six specimens of *Moroteuthis* were found in the stomach of a single sperm whale, and thirty specimens of 100 cm or smaller were found from another sperm whale.

Type B & D: *Gonatopsis borealis makko*

The position for the largest specimen (Type B) found together with *Moroteuthis* was the west Aleutian waters. Other small specimens could not be identified on the

occasion of field observations. They were described as type D and were found in the central part of the Bering Sea and the adjacent waters to the Aleutian Is. This species was also found in the comparatively high latitudes of the Bering Sea. A single occurrence was also observed in the coast of Alaskan Gulf.

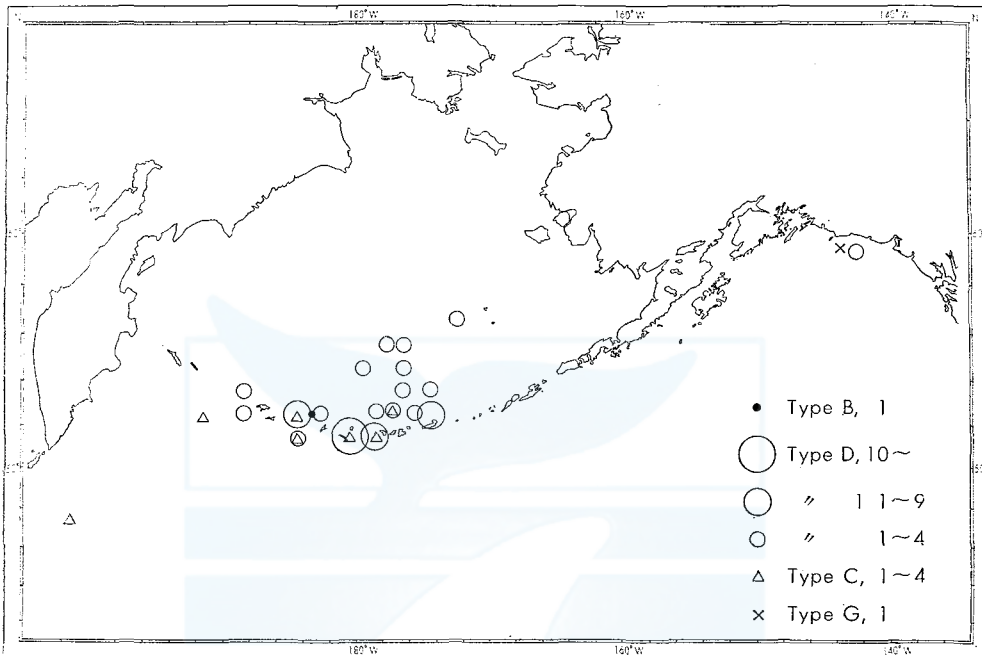

Fig. 4. Distribution of squids by type found in the stomachs of sperm whales from the Bering Sea and the Alaskan Gulf: Type B (*Gonatopsis borealis makko*), Type D (the same), Type C (*Mastigoteuthis* (?), *Stigmatoteuthis*, *Galiteuthis* and *Taonius*), and Type G (*Gonatus fabricii*).

Type C: *Mastigoteuthis*? sp., *Stigmatoteuthis* sp., *Galiteuthis armata*, and *Taonius pavo*

Above four species are described as type C on the field note although the shape and other taxonomical criteria are different. These species were mainly found in the central part of the Bering Sea as shown in Fig. 4. From the occurrences of fragmental integument in the stomachs of sperm whales, these squids were suspected to be distributed mostly the central part of the Bering Sea.

Type E: *Gonatus magister*

This species was observed in the coastal waters of Aleutian Is. and Alaskan Gulf as in Fig. 3. This species is considered to be very common in the north-eastern Pacific.

Type G: *Gonatus fabricii*

Gonatus fabricii was recorded as the main food of the toothed whale (bottle nose) in the Atlantic (Hjort & Ruud, 1929). Betesheva & Akimushkin (1955) des-

cribed considerable numbers of occurrences of this species from the adjacent waters to Kurile Is. Pike (1950) also found this species from sperm whales taken off the British Columbia coast. In the present survey, only a single large specimen was found from the Alaskan Gulf.

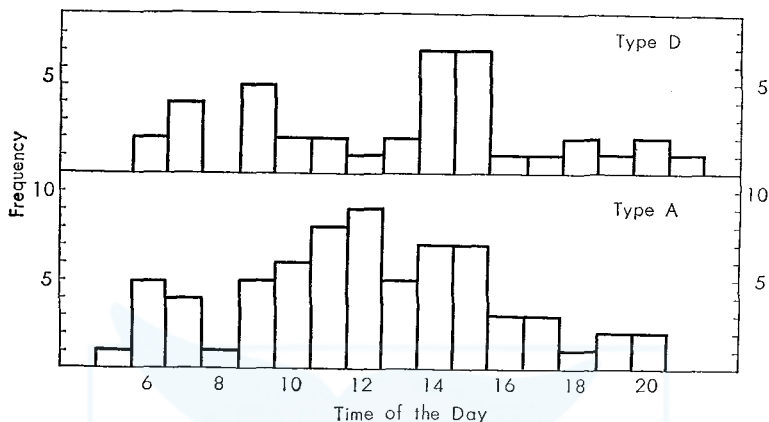

Fig. 5. Occurrences of Type A (*Moroteuthis robustus*) and Type D (*Gonatopsis borealis makko*) in the stomachs of sperm whales from the northern part of the North Pacific by hours of a day.

It is interesting to note that none of Myopsida, mostly coastal and benthonic forms, was found in the stomachs of sperm whales. Myopsida is generally tropic and temperate water forms and they are naturally not distributed in the waters of high latitudes.

SUMMARY

The squids specimens found in the stomach of sperm whales taken from the northern part of the North Pacific (Bering Sea and Alaskan Gulf) were examined.

1. *Moroteuthis robustus*, *Mastigoteuthis*? sp., *Stigmatoteuthis* sp., *Galiteuthis armaa*, *Taonius pavo*, *Gonatus magister*, *Gonatus fabricii*, and a new subspecies, *Gonatopsis borealis makko*, were found in the stomachs of sperm whales as their foods.

2. The distributions and occurrences of those squids are discussed.

Moroteuthis robustus, which is considered to be the most important squid for the food of sperm whales, is common in the adjacent waters to Aleutian Is. *Gonatopsis borealis makko* is also common not only in the central part of the Bering Sea, but also in the northern part. *Gonatus magister* is found along Aleutian Is. and Alaskan Gulf, while *G. fabricii* is found in the Alaskan Gulf. Cranchiids are discovered from the central part of the Bering Sea.

3. The distribution of those food squids is considered to be concentrated to the central part of the Bering Sea along the chain of Aleutian Is. This coincides with the major distributional area of sperm whales. On the other hand, fish as the food of sperm whales, are mainly found in the waters of the northern part of the Bering Sea and Alaskan Gulf.

REFERENCES

- AKIMUSHKIN, I.I. (1955). The feeding of the Cachalot. *C.R. Acad. Sci., U.S.S.R.* 101(6): 1139-40.
- BERRY, S.S. (1912). A review of the cephalopods of western North America. *Bull. Bur. Fisher.* 30, Doc. 761: 267-336. 25pls.
- (1913). Notes on some west American cephalopods. *Proc. Acad. Nat. Sci. Phil.* 65: 72-77.
- BETESHEVA, E.I. & AKIUMSHKNI, I.I. (1955). Food of the sperm whale (*P. catodon*) in the Kurile Islands. *Trans. Oceanogr. Inst., Moscow* 18: 86-94.
- CLARKE, R. (1955). A giant squid swallowed by a sperm whale. *Norsk Hvalfangst-Tid.* 44(10): 589-93.
- (1956). Sperm whales of the Azores. *Discovery Rep.*, 28: 237-98. 1pl.
- CLARKE, M.R. (1962). Stomach contents of sperm whales caught off Madeira. *Norsk Hvalfangst-Tid.*, 51(5): 173-91.
- HEEZEN, B.C. (1957). Whales entangled in deep sea cable. *Deep Sea Res.*, 4: 105-15.
- HJORT, J. & RUND, J.T. (1929). Whaling and fishing in the North Atlantic. *Rapp. Proc. Vverb. Ré.* 56: 5-123.
- MATTHEWS, L. H. (1938). The sperm whale (*Physeter catodon*). *Discovery Rep.* 17: 93-168. 9 pls.
- MATSUSHITA, T. (1955). Daily rhythmic activity of the sperm whales in Antarctic Ocean. *Bull. Japan. Soc. Sci. Fish.*, 20(9): 770-3.
- MIZUE, K. (1950). Food of whales (in the Adjacent waters of Japan.) *Sci. Rep. Whales Res. Inst.*, 5: 81-90.
- NEMOTO, T. & NASU, K. (1962). Stones and other aliens in the stomachs of sperm whales in the Bering Sea. *Sci. Rep. Whales Res. Inst.*, 17: 83-91.
- RICE, D.W. (1963). Progress report on biological studies of the larger cetacea in the waters off California. *Norsk Hvalfangst-Tid.*, 52(7): 181-7.
- PIKE, G.C. (1950). Stomach contents of whales caught off the coast of British Columbia. *Prog. Rep. Pacific Coast St.* 83: 27-8.
- ROBBINS, L.L., F.K. OLDHAM, & E.M.K. GEILING (1937). The stomach contents of sperm whales caught off the west coast of British Columbia. *Rep. British Columbia Museum* 1937: 10-20, 1pl.
- SASAKI, M. (1923). On a new eight-armed squid from Hokkaido, *Gonatopsis borealis* n. sp. *Ann. Zool. Jap.* 10: 203-207
- (1929). A monograph of the dibranchate cephalopods of the Japanese and adjacent waters. *J. Coll. Agr., Hokkaido Imp. Univ.*, 20: 1-357. 30pls.
- SLEPTOZOV, M.M. (1955). On the biology of cephalopod molluscs of the far-eastern seas and the north-western Pacific. *Trans. Ocenolog. Inst., Moscow*, 18: 69-77.

EXPLANATION OF THE PLATES

PLATE I

- Fig. 1. *Moroteuthis robustus* (Verrill), dorsal mantle length 700 mm.
1a. Tentacular club of another specimen.

PLATE II

- Fig. 2. *Gonatus* (s.s.) *fabricii* (Lichtenstein), dorsal mantle length 300 mm.
Fig. 3. *Stigmatoteuthis* sp. (*separata* Sasaki?), dorsal mantle length 100 mm.

PLATE III

- Fig. 4. *Gonatus* (*Berryteuthis*) *magister* Berry, dorsal mantle length 250 mm.
Fig. 4a. Tentacular club of the same specimen.

PLATE IV

- Fig. 5. *Gonatopsis borealis makko*, n. subsp., dorsal mantle length 350 mm. (Holotype)
Fig. 5a. Left lateral arms of the same specimen.
Fig. 5b. A funnel locking cartilage.
Fig. 5c. Nuchal locking cartilage.

PLATE V

- Fig. 6. *Taonius pavo* (Lesueur), anterior part of the mantle torn out, dorsal mantle length 250+x mm.
Fig. 7. An unidentified squid, probably *Mastigoteuthis* sp.

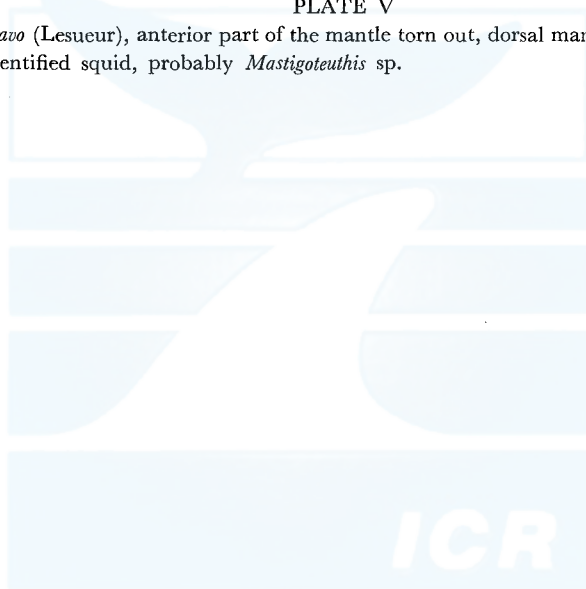







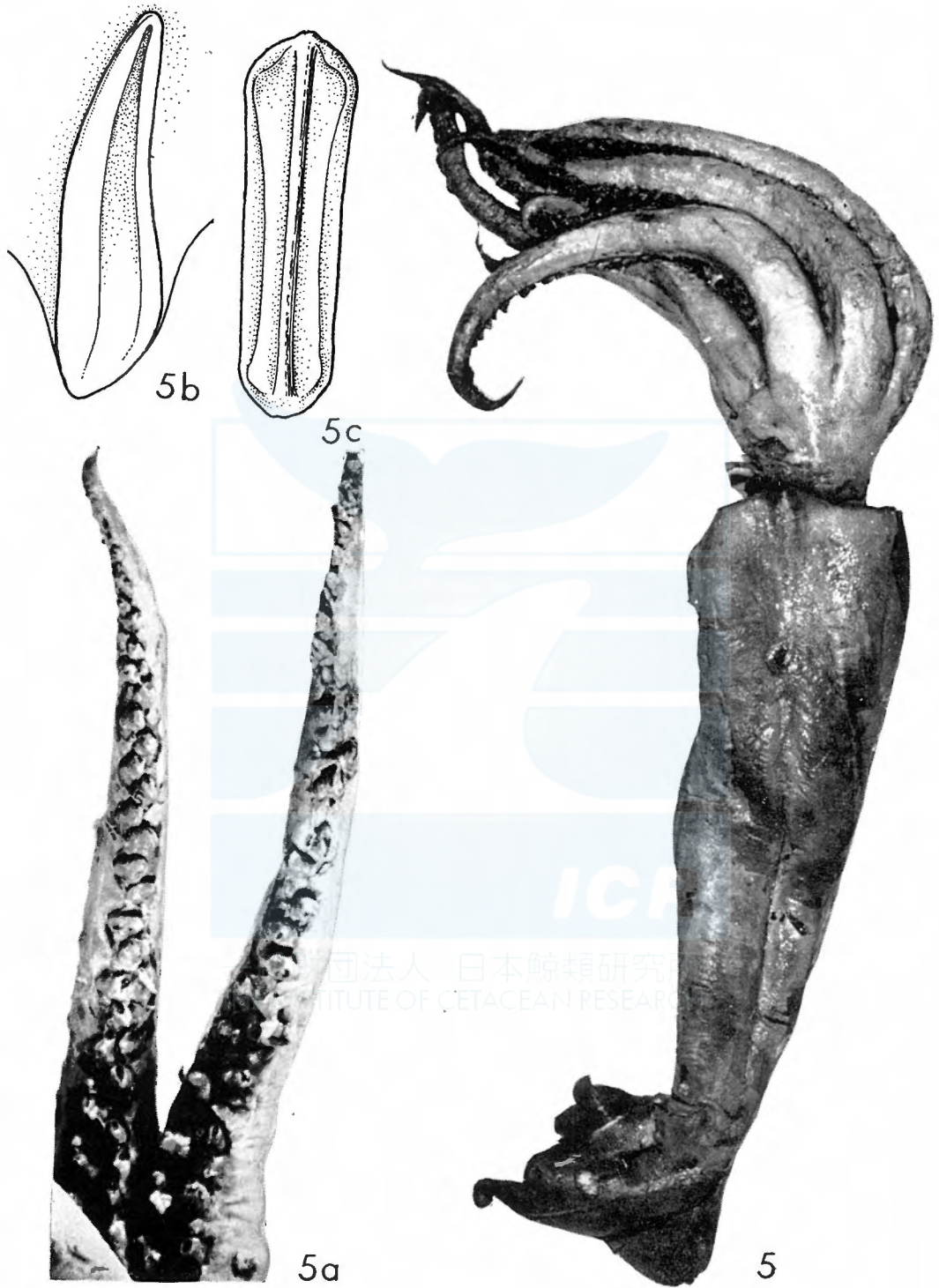



6

7

COMPARISON OF MATURITY AND ACCUMULATION RATE OF CORPORA ALBICANTIA BETWEEN THE LEFT AND RIGHT OVARIES IN CETACEA

SEIJI OHSUMI

INTRODUCTION

On the activity of ovaries in animals, there are some species of which one side of ovary is not functional, and there are other species of which both ovaries are functional. And the latter species are separated into two kinds, one is a animal of which both ovaries are active equally, the other one is a animal of which one ovary is more active than the other. Limiting to mammals, *Ornithorhynchus paradoxus* of Monotremata is functional in the left ovary only and the embryos are always found in the left uterus (Flynn & Hill, 1938). In some vespertilionid bats, only one ovary, usually the right, is functional; in others, both appear to be functional, but pregnancies are found only in the right horn of uterus (Asdell, 1946). In domestic cattle (*Bos taurus*), the right ovary tends to produce more ovulations than the left. A corpus luteum count showed 60.2% in the right ovary (Reece & Turner, 1938). According to Henning (1939), the right ovary-functions act more frequently than the left, since ovulations have been found in that ovary in $58.58 \pm 1.85\%$ of cases. The other hand, in domestic pig (*Sus scrofa*), the left ovary appears to be slightly more active than the right. Warwick (1926) reported that 55.3% of ovulation were shed from the left ovary. The left ovary of horse (*Equus caballus*) functions more frequently than the right. In a series of 185 ovulations 61% were from the left (Andrews & McKenzie, 1941). But in many animal, there is practically little or no difference in the relative activity of the two ovaries (Guinea pig, *Gavia porcellus*; domestic rabbit, *Oryctologus cuniculus*; Woodchuck, *Marmota monax*; rat, *Rattus rattus*; Bengal rhesus monkey, *Macaca mulatta* etc.), according to a book by Asdell (1946).

Concerning the difference of ovulation or pregnancy between the left and right ovaries in **CETACEA**, Sleptsov (1940) reported that in only 17% of 635 pregnant dolphin and beluga embryos were found in the right horn of uterus. And Slijper (1958) described that 'In all **ODONTOCETES** so far investigated, the fertilized ovum was almost invariably attached to the distended left horn of the uterus, while the smaller right horn was found to contain a part of the allantois. In **MYS-TICETES**, on the other hand, the foetus may develop in either horn.' In **CETACEA**, an ovum ovulated from one side of ovary, usually attached to the same side of horn of uterus (Slijper, 1949), therefore we can estimate by the horn in which foetus is, from which ovary ovulation occurred. And fortunately in **CETACEA**, all ovulations are recorded permanently in the ovaries as corpora albicantia. So, we can determine the number of ovulation by the time of investigation by

counting corpora lutea and albicantia in each ovary. Laws (1961) reported that combining both corpora albicantia and corpora lutea, of 724 fin whale (*Balaenoptera physalus*) corpora, $52.4 \pm 3.72\%$ were in right ovary and of 454 blue whale (*Balaenoptera musculus*) corpora, $52.4 \pm 4.68\%$ were in right ovary, and he estimated possibility that there is a slight prevalence of right side in both species. Sergeant (1962) described that from the distribution of corpora lutea and albicantia in 42 ovary pairs of the pilot whale (*Globicephala melaena*) it was found that 70% of ovulations on average took place from the left ovary with wide individual variation in incidence of scars between two ovaries.

Reviewing the above reports, they seems to investigate the comparison of ovulation between the left and right ovaries including all age groups, and it seems that there is no report on the variation of accumulation rate of corpora in one side of ovary according to the increment of age. I studied the number of corpora lutea and albicantia between the left and right ovaries in 23 species of **CETACEA**, for the purpose of coparison of maturity and variation of corpora accumulation rate between the left and right ovaries. And then taxonomic consideration was given on the typing of relative corpora accumulation and interrelationship of the types.

I wish to express my sincere thanks to Dr. D. E. Sergeant of the Fisheries Research Board of Canada, Dr. M. Nakajima of the Enosima Marineland, Drs. M. Nishiwaki and T. Nemoto and Mr. T. Ichihara of our Institute, who kindly gave their valuable data for my study. Present paper would not be completed, if I did'nt get their valuable materials. Especially Drs. Sergeant and Nishiwaki gave me many data and many suggestions. I am indebted to Professor H. Hosokawa of Department of Anatomy, School of Medicine, University of Tokyo, Assistant Professor T. Hibiya of Department of Fisheries, School of Agriculture, University of Tokyo and Dr. H. Omura, Director of our Institute for their helpful comment on my draft.

MATERIAL

Species, locality, number of samples, and investigator used in this study are shown in Table 1. To my regret, I collected the data on only 23 species, and they are not contained in all Genera of **CETACEA**.

Ovaries are convinced of the left and right, and number of corpora lutea and albicantia in each ovary are counted as accurate as possible. Mature ovary is defined as that in which more than one corpus luteum or albicans is accumulated, and I did not use an individual of which both ovaries are immature as the material for this paper.

As mentioned in above chapter, in **CETACEA**, corpus albicans is considered to be not absorbed. Therefore, the ovulations are recorded permanently as corpus albicans. Although there are individual variation in the ovulation rate, number of corpora albicantia is related to age in average. Then, the comparison of maturity and accumulation rate of corpora between the left and right ovaries are able to be examined by the comparison of number of corpora in the left or right ovary to the

total number of corpora in both ovaries.

Frequencies of number of corpora in the left ovary in each class of number of corpora in both ovaries are tablated for eight species as shown in Appendix-Tables. Frequency of number of corpora in the right ovary is calculated easily from the table. From an Appendix-Table, a figure which shows a process of relative accumulation of corpora in the left and right ovaries is drawn for each species. On the species of which samples are small, individual data are plotted in the figure, and estimated mean curves of accumulation of corpora are drawn in the left and right ovary. Other species of which samples are collected more than 40, I calculated average number of corpora in the left or right ovary in adequate class of total number of corpora, and connected each average values by straight line.

TABLE 1. LIST OF SPECIES AND NUMBER OF INDIVIDUALS EXAMINED IN THIS PAPER

Species	Locality	No. of specimen	Investigator
<i>Balaenoptera musculus</i>	N. Pacific	57	S. OHSUMI
— <i>physalus</i>	N. Pacific	297	S. OHSUMI
— <i>edeni</i>	Japan	54	S. OHSUMI
— <i>borealis</i>	Antarctic	80	S. OHSUMI
— <i>acutorostrata</i>	Japan	2	T. ICHIHARA
<i>Megaptera novaeangliae</i>	N. P. and Ant.	100	S. OHSUMI
<i>Eubalaena glacialis</i>	N. P. and Ant.	3	T. NEMOTO and MATTHEWS (1938)
<i>Physeter catodon</i>	Japan	298	S. OHSUMI
<i>Kogia sp.</i>	Japan	1	S. OHSUMI
<i>Berardius bairdii</i>	Japan	13	S. OHSUMI
<i>Ziphius cavirostris</i>	Japan and N.P.	3	S. OHSUMI and KENYON (1961)
<i>Delphinapterus leucus</i>	Hudson Bay	16	D. E. SERGEANT
<i>Phocaenoides dalli</i>	Japan	5	S. OHSUMI
<i>Grampus griseus</i>	Japan	2	M. NAKAJIMA
<i>Globicephala melaena</i>	Newfoundland	173	D. E. SERGEANT
— <i>scammoni</i>	Japan	7	S. OHSUMI
<i>Orcinus orca</i>	Japan	1	S. OHSUMI
<i>Feresa attenuata</i>	Japan	4	M. NISHIWAKI and S. OHSUMI
<i>Lagenorhynchus obliquidens</i>	Japan	1	M. NAKAJIMA
<i>Tursiops truncatus</i> *	Japan	26	M. NISHIWAKI, M. NAKAJIMA and S. OHSUMI
<i>Delphinus delphis</i>	Japan	6	M. NISHIWAKI, and M. NAKAJIMA
<i>Stenella attenuata</i>	Japan	3	M. NAKAJIMA
— <i>caerulealba</i>	Japan	333	M. NISHIWAKI and S. OHSUMI

* More taxonomic studies are needed on this species.

RESULTS

Balaenoptera musculus

Slijper (1949) reported 59% of pregnancies came from the left ovary in the blue whale, and Laws (1961) described that of 454 corpora, $52.4 \pm 4.86\%$ were in right ovary. According to my material, total corpora in the left ovaries are 47.4% of total number of corpora in both ovaries.

As shown in Appendix-Table 1, each ovary attains to maturity by the time of two ovulations in each other side of ovary. And as shown in Fig. 1, accumulation rates of corpora are almost piled up each other in both sides of ovaries.

Considering above phenomenon, I conclude that in *Balaenoptera musculus* the left and right ovaries attain at maturity in the same time and ovulation occurs alternately from the left and right ovary in average.

Balaenoptera physalus

Many materials are obtained for this examination from the northern part of the North Pacific. In total individuals, 51.9% of corpora accumulated in the left ovary. Slijper (1949) reported the percentage of existence of corpus luteum of pregnancy on 17, fin whales and the result was 65% of fin whales the corpus luteum was in the right ovary. However, Laws (1961) describes that combining the corpora lutea and albicantia, of 724 fin whale corpora, $52.4 \pm 3.72\%$ were in the right ovary, and he states it seems possible that there is a slight prevalence of the right side in the fin and blue whale. My result is that the left side is slightly more, but it is included into the standard deviation by Laws (1961).

Appendix-Table 4 shows the distribution of number of corpora in the left ovary in each class of number of corpora in both ovaries. There is individual variation, for instance, in the 8 corpora class in both ovaries, the number of corpora in the left ovary distribute from 2 to 7, but the average is 4.6. That is to say, the average of corpora in the right ovary is 3.4. The left ovary attains to maturity by the time when the other side of ovary accumulated 4 corpora, on the other hand, right ovary attains to maturity by the time when 6 corpora accumulate in the left ovary.

As shown in Fig. 1, the maturity and the relative accumulation rate of corpora are almost the same between the left and right ovary in average.

Balaenoptera edeni

Materials were collected from Japanese coast. In total of 54 whales, 48.7% of corpora accumulate in the left ovary. Each ovary attains to maturity by 3 corpora accumulate in each other side of ovary. And as shown in Fig. 1, the maturity and relative accumulation rate of corpora are seemed in average to be the same between the left and right ovary, although there is some individual variation.

Balaenoptea borealis

Materials were obtained from the Antarctic Areas IV, V, and VI. 49.7% of corpora accumulate in the left ovary. The individual variation is seemed not to be so wide as *Balaenoptera physalus*. The left ovary attains to maturity by 5 corpora accumulate in the right ovary, on the other hand, the right ovary attains to maturity by 4 corpora accumulate in the left ovary. The average accumulation of corpora in each ovary is shown in Fig. 2, and maturity and corpora accumulation is almost the same each other between the left and right ovary.

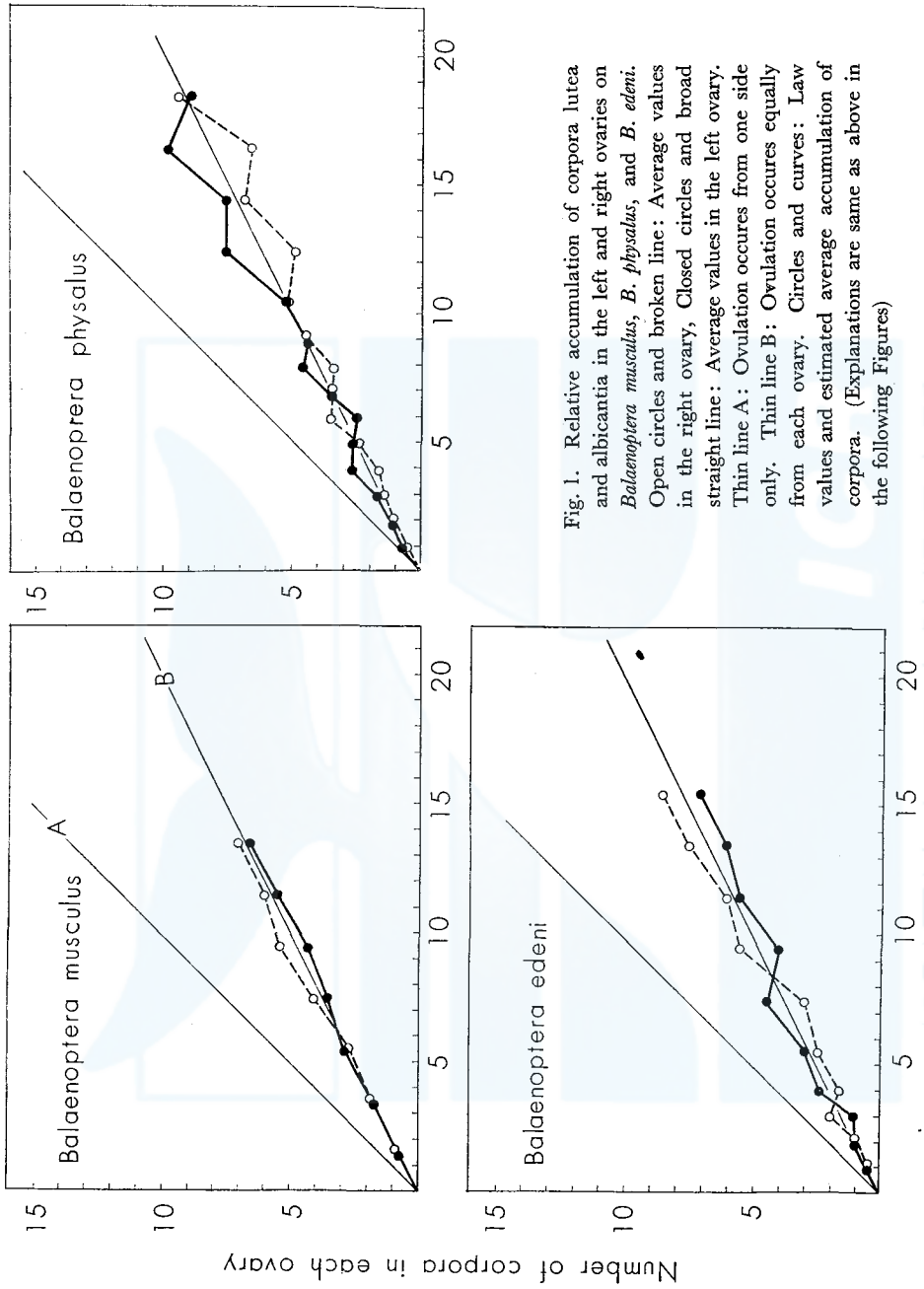

Fig. 1. Relative accumulation of corpora lutea and albicantia in the left and right ovaries on *Balaenoptera musculus*, *B. physalus*, and *B. edeni*. Open circles and broken line: Average values in the right ovary, Closed circles and broad straight line: Average values in the left ovary. Thin line A: Ovulation occurs from one side only. Thin line B: Ovulation occurs equally from each ovary. Circles and curves: Law values and estimated average accumulation of corpora. (Explanations are same as above in the following Figures)

中国科学院海洋研究所
THE INSTITUTE OF CETACEAN RESEARCH

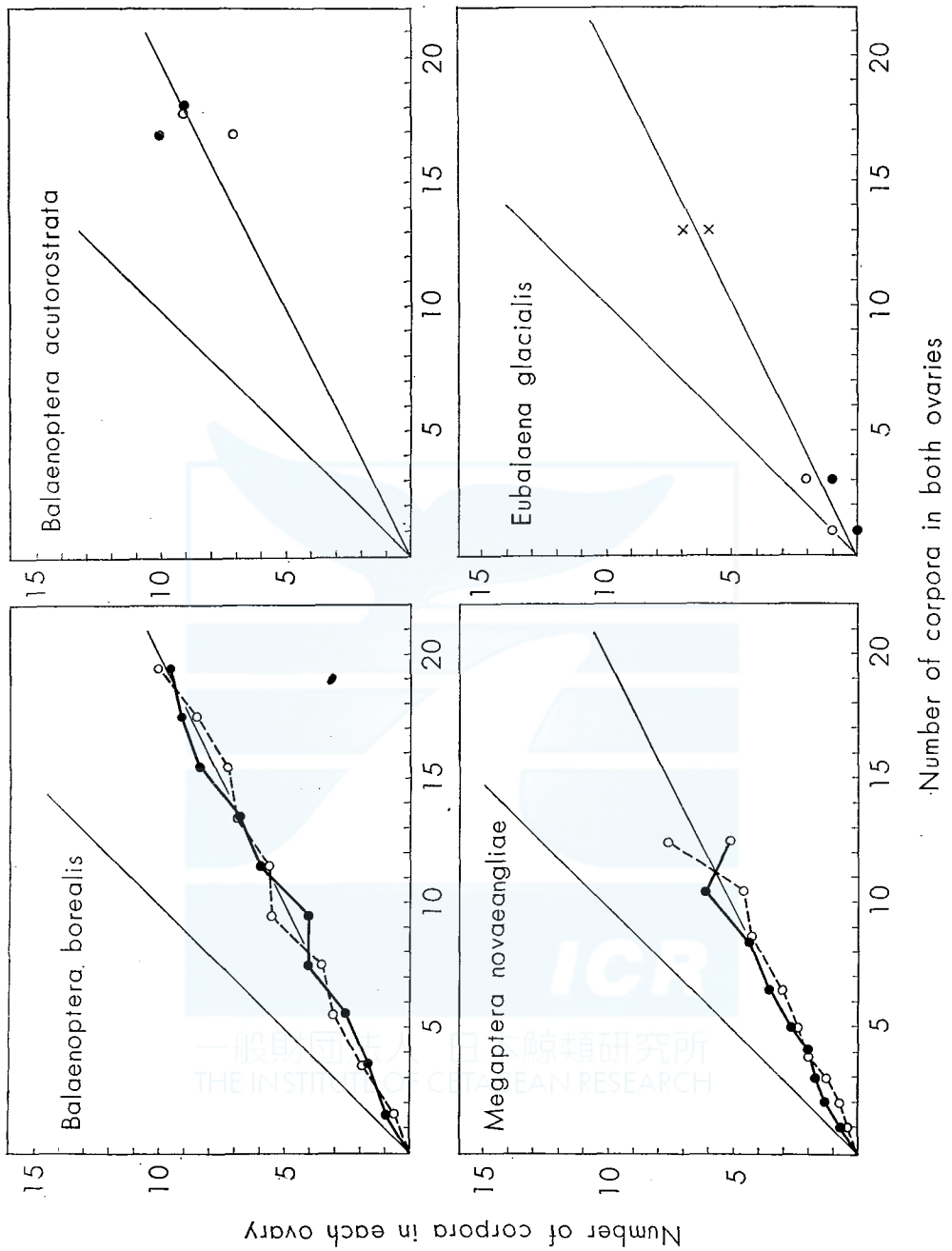

Fig. 2. Relative accumulation of corpora in the left and right ovaries on *Balaenoptera borealis*, *B. acutorostrata*, *Megaptera novaeangliae* and *Eubalaena glacialis*. Cross: Unknown which is the left or the right ovary.

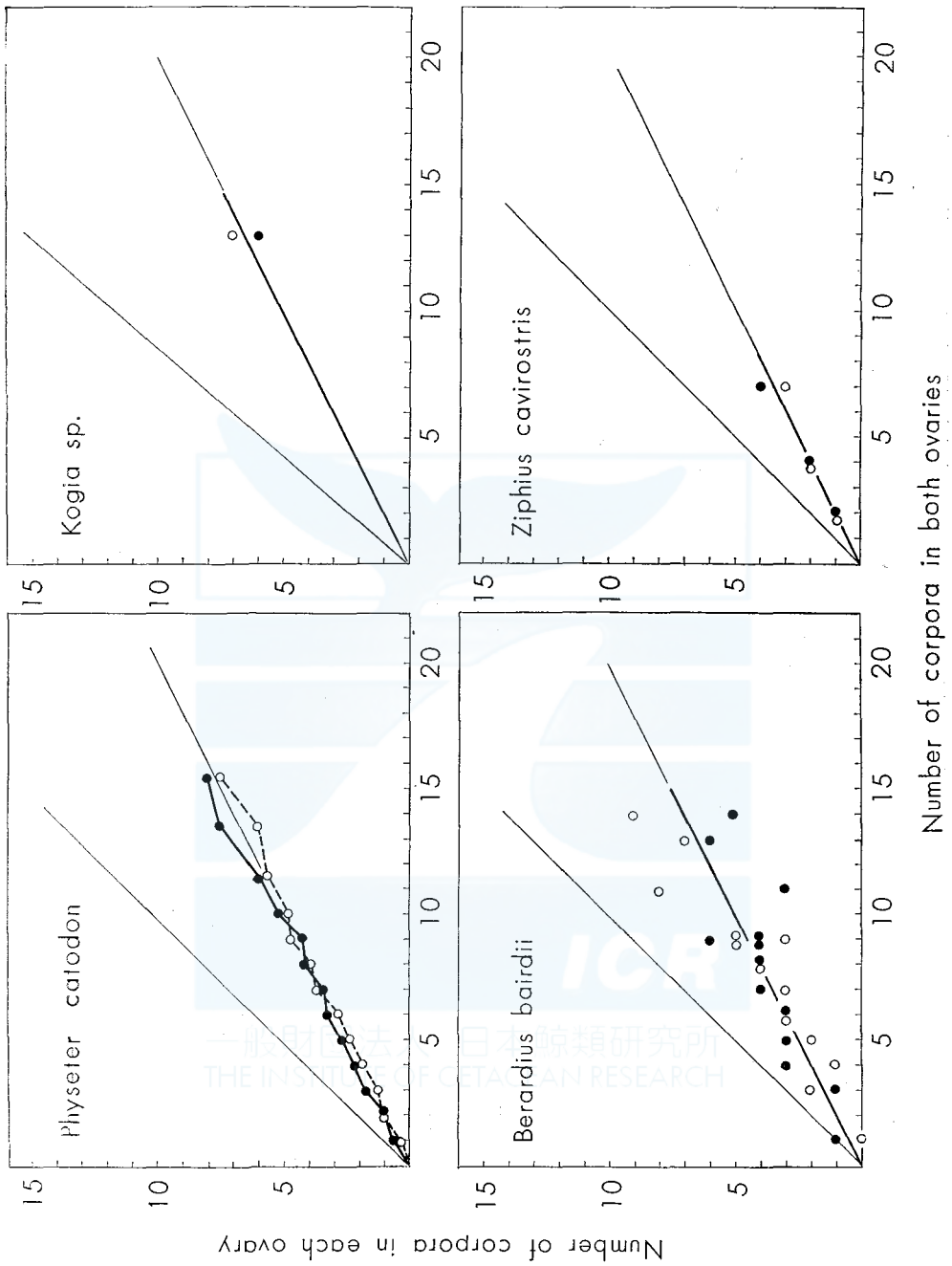

Fig. 3. Relative accumulation of corpora in the left and right ovaries on *Physeter catodon*, *Kogia sp.*, *Berardius bairdii* and *Ziphius cavirostris*.

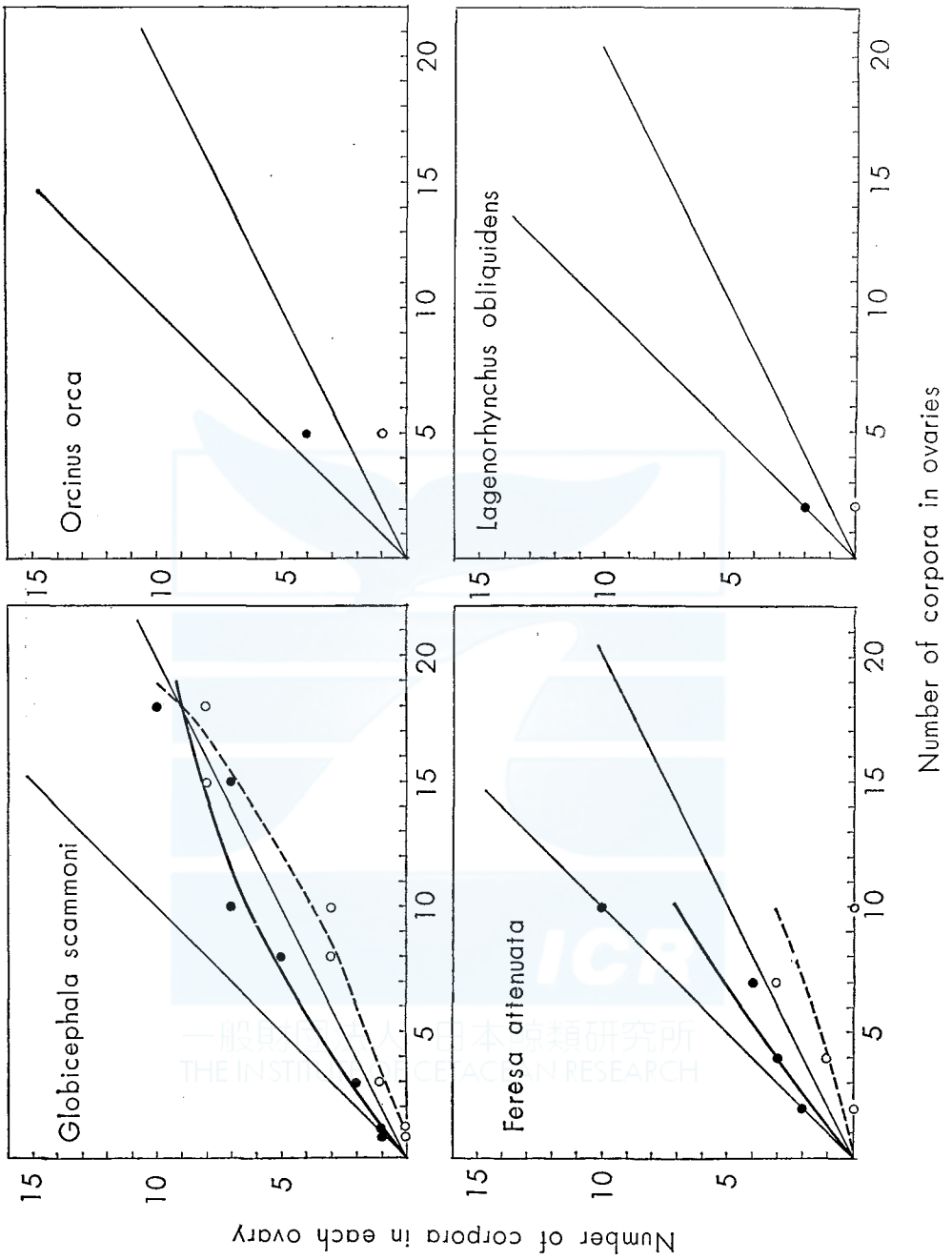

Fig. 4. Relative accumulation of corpora in the left and right ovaries on *Delphinapterus leucus*, *Phocaenoides dalli*, *Grampus griseus* and *Globicephala melaena*.

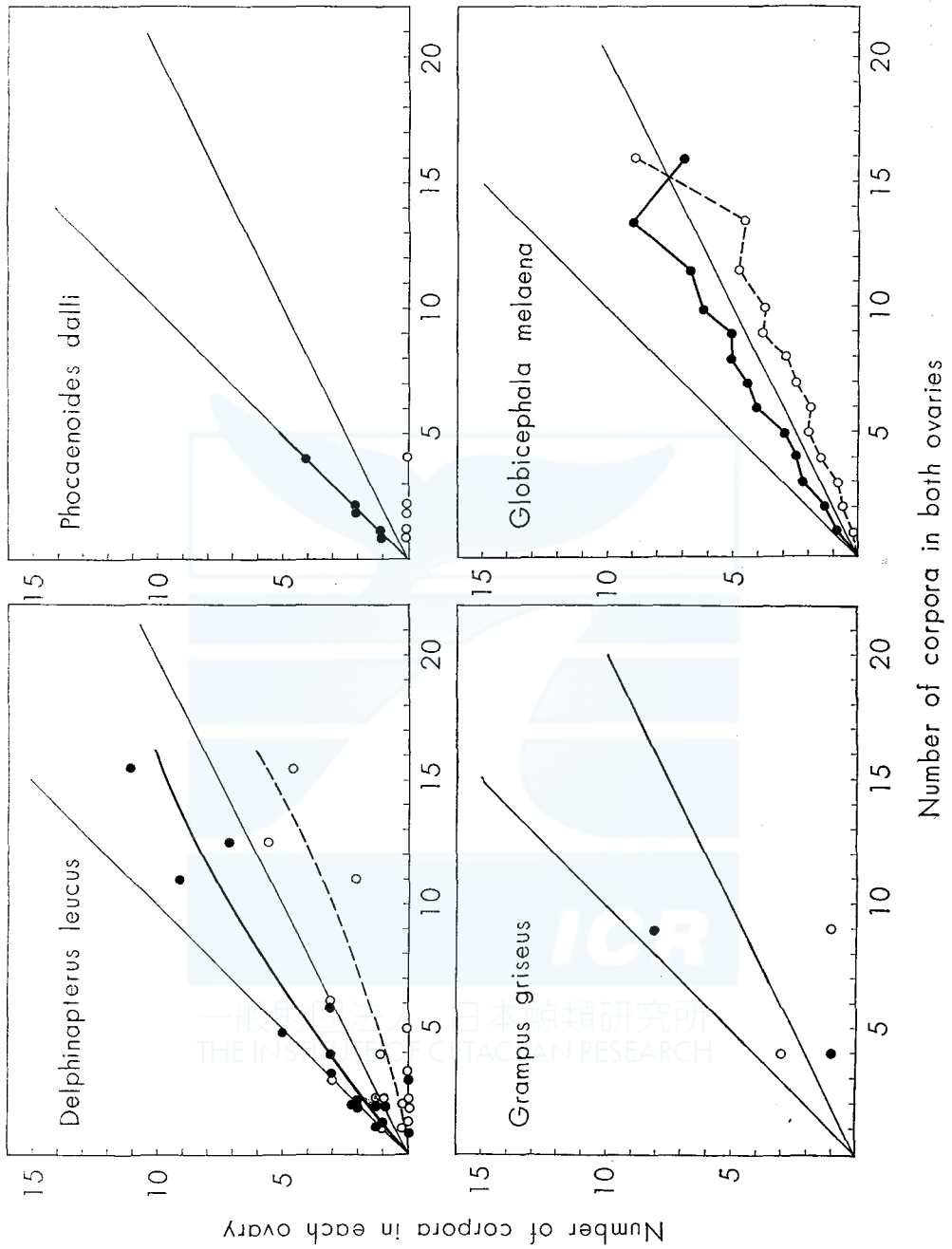

Fig. 5. Relative accumulation of corpora in the left and right ovaries on *Globicephala scammoni*, *Orcinus orca*, *Feresa attenuata* and *Lagenorhynchus obliquidens*.

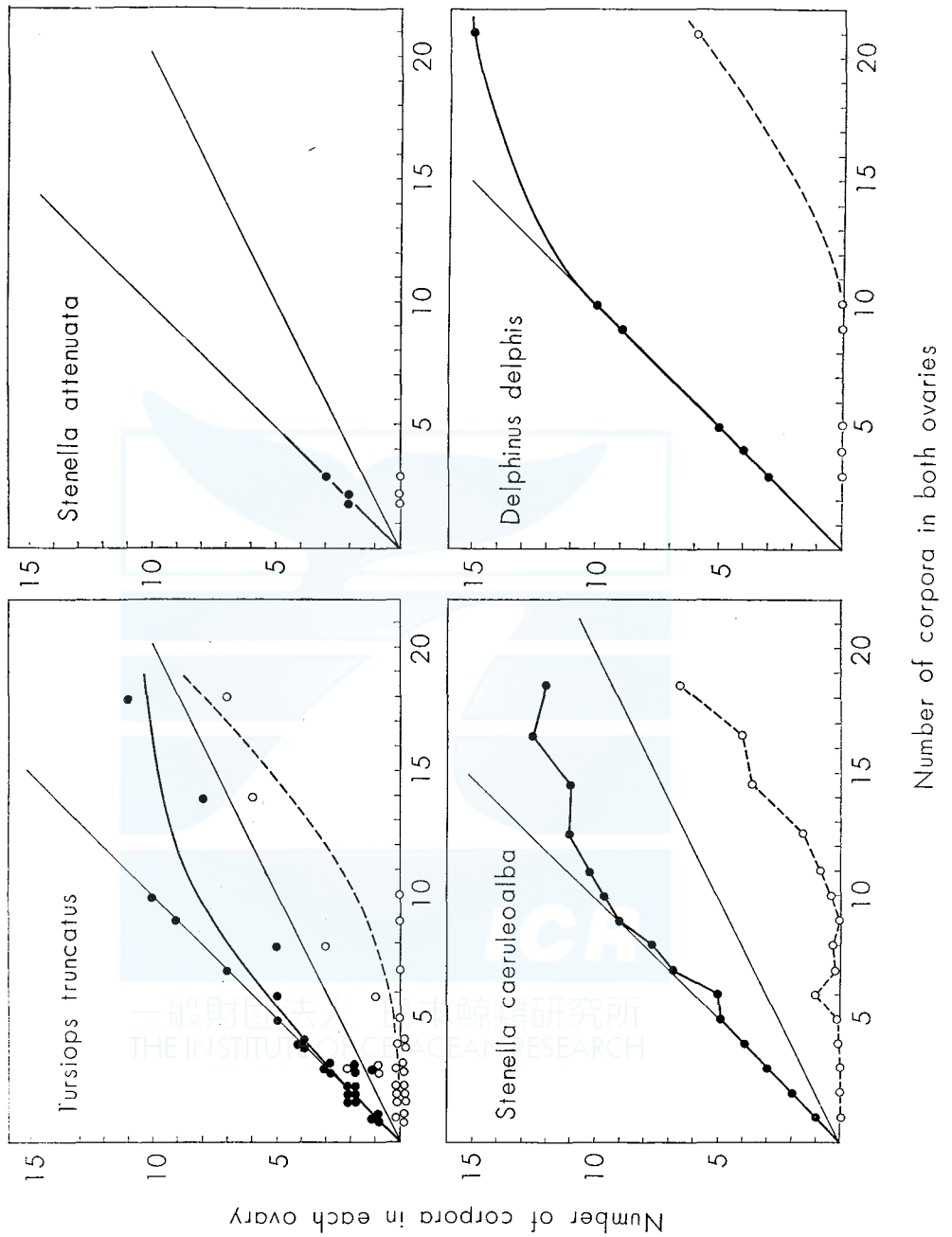

Fig. 6. Relative accumulation of corpora in the left and right ovaries on *Tursiops truncatus*, *Stenella attenuata*, *S. caeruleoalba* and *Delphinus delphis*.

Balaenoptera acutorostrata

I have only two materials. But as shown in Fig. 2, the maturity and corpora accumulation is seemed to show the same type as the above species.

Megaptera novaeangliae

I used the ovaries materials from the Antarctic and the North Pacific. In the total of 100 individuals, 53.4% of corpora accumulate in the left ovary. The left ovary attains to maturity by 5 corpora in the right ovary, and the right ovary attains to maturity by 4 corpora in the left ovary. But in average, as shown in Fig. 2, the left and right ovaries are almost the same in the maturity and relative accumulation of corpora.

Eubalaena glacialis

By 1963, 11 right whales were killed by Japan in the North Pacific on the special permission of scientific research. Among them female whales are 4. The ovaries of one of the females were entirely immature and no follicle was seen on their surface (Omura, 1958). The ovaries of the second female are seemed to be prepuberal, because one follicle of which diameter is 3.8 cm is seen in the left ovary but there is not difference in the size between the both ovaries (Left: 30.0 × 12.0 cm, Right: 31.0 × 11.5 cm), and they are considered to be almost the same stage from the observation by naked eye. Other two females are both pregnant. One individual has only one corpus luteum in the right ovary and there is no corpus albicans in both ovaries. The other individual has one corpus luteum in the left ovary and two corpora albicantia in the right ovary.

Matthews (1938) reported that No. 1019 right whale in the southern hemisphere had one corpus luteum and 6 corpora albicantia in one side of ovary, and has 6 corpora albicantia in the other side of ovary.

Although I have small data on this species, and it is difficult to conclude, I estimate that maturity and relative corpora accumulation are the same in average between the both ovaries like the above 6 species.

Physeter catodon

Materials were obtained in the coast of Japan. In the total 298 whales, 51.6% of corpora accumulate in the left ovaries. From this point, we can estimate that ovulation occurs equally from the both sides of ovaries. Appendix-Table 6 shows the distribution of corpora in the left ovary. Each ovary attains to maturity by 5 corpora accumulate in the other side of ovaries. Deviation of corpora is not so wide even if in the old stages. As shown in Fig. 3, the maturity and relative accumulation rate of corpora is seemed to be equal in the both side of ovaries like as **MYSTACOCETI**.

Kogia sp.

A *Kogia* was caught in a coast of Japan. Dr. M. Nakajima investigated and collected many materials on the species, but it is not yet identified. This individual has 6 corpora albicantia in the left ovary and 7 corpora albicantia in the right ovary.

I have only one material, but I estimate that this species will be the same tendency as *Physeter catodon*.

Berardius bairdii

13 individuals were examined the corpora counts separating the left and right ovaries. 47 corpora (47.5%) accumulated in the left ovary. Although the materials are not so many, we can estimate the maturity and relative accumulation will be the same between the both ovaries.

Ziphius cavirostris

I have only two materials from the coast of Japan. And Kenyon (1961) describes that one corpus albicans accumulated in each ovary of a female. Considering the above data and Fig. 3, I estimate that the tendency of maturity and corpora accumulation will be the same as *Physeter*.

Delphinapterus leucus

In the total corpora, 68.9–70.8% of corpora accumulate in the left ovary, and apparently the ovulations from the left ovary exceed those from the right side.

As shown in Fig. 4, there is an individual of which right ovary is still immature when 5 corpora accumulate in the left ovary. On the contrary, there is an individual of which left ovary is still immature when 3 corpora accumulate in the right ovary. The right ovary in average attains to maturity later than the left ovary, but the deviation is not so much. Relative accumulation rate in the right ovary is somewhat lower than that in the left ovary in younger stage, but the deviation of corpora accumulation between the both ovaries seems to become shorter gradually.

Phocaenoides dalli

There are 5 pairs of ovaries taken in the coast of Japan.

Unfortunately they are all relatively young stage (the oldest individual has only 4 corpora in the both ovaries), and data are given from only 5 individuals. Therefore, conclusion will be not introduced, but all corpora accumulate from the left ovary. Right ovary is still immature, when 4 corpora accumulate in the left ovary. And the size of ovary is smaller in the right ovary than in the left ovary.

Grampus griseus

One individual has one corpus albicans in the left ovary and one corp. luteum and two corp. albicantia in the right ovary, whereas the other individual has one corp. luteum and 7 corp. albicantia in the left ovary and one corp. albicans in the right ovary. Then, 69.2% of corpora accumulate in the left ovary.

Globicephala melaena

In total corpora, 65.5% of corpora accumulate in the left ovary, therefore ovulation occurs more frequently from the left ovary than from the right ovary.

Left ovary attains to maturity by the time when 9 corpora accumulate in

the right ovary, on the contrary, there is an individual of which right ovary is immature when 9 corpora accumulate in the left ovary. As shown in Appendix-Table 7, there are many individuals of which left ovary is mature but the right ovary is still immature.

Fig. 5 shows the average corpora in the left and right ovaries in each total corpora class. From this figure relative corpora accumulation in the left ovary exceeds that in the right ovary.

Globicephala scammoni

I have only 7 data on the corpora count on this species. Considering Fig. 5, the relative accumulation curve is similar with that of *Globicephala melaena*. 58.9% of corpora accumulate in the left ovary.

Orcinus orca

I have only one corpora count on this species. One corpus luteum and 3 corpora albicantia accumulate in the left ovary and one corp. albicans exists in the right ovary. Assuming from only this specimen, this species is included into the similar type as *Globicephala*.

Feresa attenuata

There is an individual of which right ovary is still immature when 10 corpora accumulate in the left ovary. However, in total corpora, 82.6% of corpora accumulate in the left ovary. Although there are scanty of data, the relative corpora accumulation will be similar with that of *Globicephala*.

Lagenorhynchus obliquidens

I have only one material. This individual has two corpora albicantia in the left ovary, but the right ovary is still immature.

Tursiops truncatus

Zoological name of this species caught in the coast of Japan must be studied further, but I used it as *T. truncatus* according to Ogawa (1938).

82.8% of corpora accumulate in the left ovary, and all left ovaries are mature in the materials, but mature right ovary appears from the time when 3 corpora accumulate in the left ovary. And there is an individual of which right ovary is immature when 10 corpora accumulate in the left ovary. From Fig. 5, it will be assumed that the left ovary attains at maturity first, and in younger stage ovulation occurs in average from only the left ovary. Then, after attainment of later maturity of the right ovary, relative corpora accumulation rate of the right ovary will be larger than the left ovary.

Delphinus delphis

Of total individual, 88.5% corpora accumulate in the left ovary. In 5 individuals of total 11 corpora only the left ovaries are mature. The other in-

dividual has 15 corpora albicantia in the left ovary and 6 corpora albicantia in the right ovary. From Fig. 6, it will be considered that the right ovary attains to maturity by the time when about 10 corpora accumulate in the left ovary, after then relative accumulation rate will be more in the right ovary than in the left ovary.

Stenella attenuata

I have 3 corpora counts taken and kept in Japan. The data are scant and got from young animals, but all corpora accumulate in only the left ovary.

Stenella caeruleoalba

As many as 333 materials are obtained from the coast of Japan as shown in Appendix-Table 8.

There is no individual of which only left ovary is immature. On the other hand, there are many individuals of which right ovary is still immature by the time when 14 corpora accumulate in the left ovary. 93.4% of corpora accumulate in the left ovary in total corpora.

In average, ovarian maturity occurs from the left ovary first, and until the time when about 9 corpora accumulate in the left ovary, the right ovary is still immature. But the right ovary is not immature for life. After the maturity of the right ovary, relative corpora-accumulation rate becomes more in the right ovary than in the left ovary.

TYPES OF CORPORA ACCUMULATION IN BOTH SIDES OF OVARIES

Considering the relative corpora-accumulation curves, we can classify them into three kinds of types for 23 kinds of Cetacean species.

Type I: Left and right ovaries attain to maturity almost the same time in average, and there is no difference in the relative accumulation rate of corpora between the left and right ovary. Following 10 species are considered to be included into this kind of type: *Balaenoptera musculus*, *B. physalus*, *B. edeni*, *B. borealis*, *B. acutorostrata*, *Magaptera novaeangliae*, *Eubalaena glacialis*, *Physeter catodon*, *Berardius bairdii*, and *Ziphius cavirostris*. I have only one *Kogia sp.* of which ovaries are examined. So, it is dangerous to conclude, but I consider that this species is also included in Type I.

Type II: Maturity of right ovary is attained somewhat later than the left. Relative accumulation rate of corpora in the left ovary is more than that in the right during young stage, but the difference between the left and right ovaries is not so much. In older stage, relative accumulation rate of corpora in right ovary exceeds that of the left ovary. Following 4 species are considered to be included into Type II: *Delphinapterus leucus*, *Globicephala melaena*, *G. scammoni* and *Feresa attenuata*.

Owing to the deficiency of samples, I could not determine the type of corpora accumulation for *Grampus griseus* and *Orcinus orca*. But I presumably consider they are also included into this kind of type.

Type III: Remarkable difference of corpora-accumulation rate occurs between the left and right ovaries. Left ovary attains to maturity earlier than the right. And for relatively long time, ovulation occurs from only left ovary. But after

attainment of maturity of right ovary, the ovulation from right ovary becomes more frequently than the left. Following 5 species are considered to be included into this type: *Phocaenoides dalli*, *Tursiops truncatus*, *Delphinus delphis*, *Stenella attenuata* and *S. caeruleoalba*.

On *Lagenorhynchus obliquidens*, I have only one material, so I hesitate to conclude that this species is included in Type III, but I think it is possible.

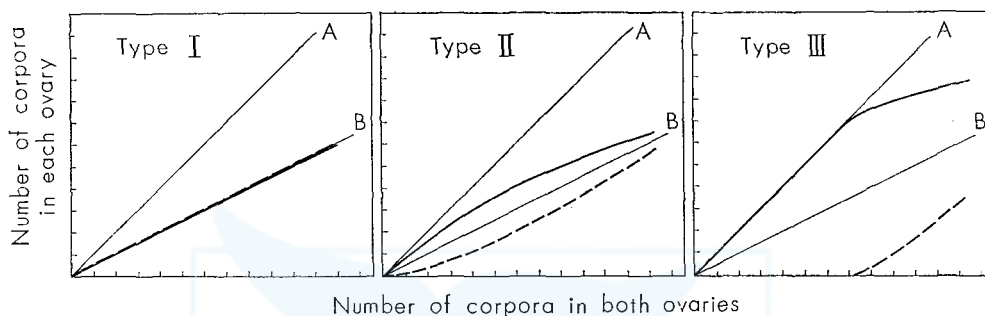

Fig. 7. Schematic figures of the three kinds of types of relative corpora accumulation in the left and right ovaries of cetacea.

Broad solid line: Left ovary, Broad broken line: Right ovary, A-line: Ovulation occurs from only one side of ovaries, B-line: Both ovaries attains to sexual maturity in the same time and ovulation occurs equally from both sides of ovaries.

Table 2 shows the accumulation type and the per cent of number of ovulations (number of corpora lutea and albicantia) from the left ovaries to total ovulations from both ovaries for 23 species of **CETACEA** examined. As shown in the previous figures, such percents must be variable according to the variation of age distribution, especially in Types II and III. For instance, in *Stenella caeruleoalba*, if we collect only young animals, the percentage of ovulation in the left ovary is near 100%. On the contrary, if we collect only older animals, the percentage decreases remarkably. Therefore, I want to emphasize on this phenomenon. Previous workers reported percentage of the existence of fetuses in left or right uterine cornu (Sleptsov, 1940; Slijper, 1949 etc.) or percentage of number of corpora in left or right (Laws, 1961; Sergeant, 1962). But I think they did not consider the above phenomenon.

Nevertheless, as shown in Table 2, the percentages of total ovulation from left ovary to that from both ovaries are seemed to have relation with the types of corpora accumulation. That is to say, it is as a matter of course, the percentages of ovulation from left ovary are distributed between 45 and 55% in 11 species of Type I. They are 52.0% in average. In Type II, percentages of ovulation from the left ovary are distributed between 58 and 83% for 6 species. They are apparently separate from the values of Type I. And in average 65.9% of ovulations occurs from the left ovaries on the 6 species.

Type-III species have much percentage of ovulation from the left ovaries. The range of the ratios is between 82 and 100% and the average is calculated as 92.7% for the 6 species.

I consider that if we have only material on the distribution of corpora in left and right ovary or the percentage of foetal existence in the left or right uterine cornu on one species, we can estimate briefly in what kind of corpora-accumulation type the animal is classified.

TABLE 2. TYPES OF CORPORA ACCUMULATION AND TOTAL NUMBER OF CORPORA

Species	No. of specimens	No. of Type	No. of total corpora		L%*
			Left	Right	
<i>Balaenoptera musculus</i>	57	I	755	172	47.4
— <i>physalus</i>	297	I	1056	981	51.9
— <i>edeni</i>	54	I	147	155	48.7
— <i>borealis</i>	80	I	350	354	49.7
— <i>acutorostrata</i>	2	I	19	16	59.3
<i>Megaptera novaeangliae</i>	100	I	198	173	53.4
<i>Eubalaena glacialis</i>	3	I	7-8	9-10	41.2-47.1
<i>Physeter catodon</i>	298	I	909	853	51.6
<i>Kogia sp.</i>	1	I?	6	7	46.2
<i>Berardius bairdii</i>	13	I	47	52	47.5
<i>Ziphius cavirostris</i>	3	I	7	6	53.8
<i>Delphinapterus leucus</i>	16	II	51	21-23	68.9-70.8
<i>Phocaenoides dalli</i>	5	III	10	0	100.0
<i>Grampus griseus</i>	2	II?	9	4	69.2
<i>Globicephala melaena</i>	173	II	607	320	65.5
— <i>scammoni</i>	7	II	33	33	58.9
<i>Orcinus orca</i>	1	II?	4	1	80.0
<i>Feresa attenuata</i>	4	II	19	4	82.6
<i>Lagenorhynchus obliquidens</i>	1	III?	2	0	100.0
<i>Tursiops truncatus</i>	26	III	101	21	82.8
<i>Delphinus delphis</i>	6	III	46	6	88.5
<i>Stenella attenuata</i>	3	III	7	0	100.0
— <i>caerulealba</i>	333	III	1750	123	93.4

* Per cent of number of corpora in the left ovary to total corpora in both ovaries.

TAXONOMIC CONSIDERATION ON THE TYPES OF RELATIVE CORPORA ACCUMULATION IN CETACEA

In the previous chapter, I classified the relative corpora-accumulation curves into three kinds of types.

Among 23 species examined, there are only three genera in which more than two species are included (*Balaenoptera*, *Globicephala* and *Stenella*). But we can find that the species included in same genus show the same type of corpora accumulation. Then, I arrange genera of living **CETACEA** in Table 3. Types of corpora accumulation and the combination of genera by Flower & Lydekker (1891), Winge (1918), Fraser (1938), Simpson (1945) and Nishiwaki (1963, 1964) are also recorded in this table.

To my regret, I could not examine the types of corpora accumulation on all

TABLE 3. TYPES OF CORPORA ACCUMULATION AND THE COMBINATION OF GENERA IN LIVING CETACEA BY FIVE AUTHORS

Genus	Type	FLOWER & LYDEKKER (1894)	WINGE (1918)	FRASER (1938)	SIMPSON (1945)	NISHIWAKI (1963-64)
<i>Balaenoptera</i>	I	BALAENIDAE	BALAENOPTERINI	BALAENOPTERIDAE	BALAENOPTERIDAE	BALAENOPTERIDAE
<i>Megaptera</i>	I					
<i>Rhachianectus</i>				RHACHIANECTIDAE	RHACHIANECTIDAE	RHACHIANECTIDAE
<i>Neobalaena</i>	I		BALAENINI	BALAENIDAE	BALAENIDAE	BALAENIDAE
<i>Balaena</i>	I					
<i>Physeter</i>	I	PHYSETERINAE	PHYSETERES-PHYSETERINI	PHYSETERIDAE	PHYSETERINAE	PHYSETERIDAE
<i>Kogia</i>	I?					
<i>Hyperoodon</i>	I	PHYSETERIDAE	HYPERODONTES	PHYSETERIDAE	PHYSETERIDAE	PHYSETERIDAE
<i>Berardius</i>	I					
<i>Ziphius</i>	I	ZIPHINAE	ZIPHINI	ZIPHIDAE	ZIPHIDAE	ZIPHIDAE
<i>Tasmacetus</i>						
<i>Mesoplodon</i>						
<i>Pontoporia</i>						
<i>Lipotes</i>						
<i>Inia</i>		PLATANIIDAE		PLATANIIDAE		PLATANIIDAE
<i>Platanista</i>						
<i>Monodon</i>	II		MONODONTES	DELPHINAPTERINAE	MONODONTIDAE	MONODONTIDAE
<i>Delphinapterus</i>						
<i>Neophocaena</i>	II		PHOCAENAE		PHOCAENIDAE	PHOCAENIDAE
<i>Phocoena</i>	III					
<i>Phocaenoides</i>						
<i>Orcella</i>	II?					
<i>Grampus</i>	II					
<i>Globicephala</i>	II?					
<i>Orcinus</i>						
<i>Pseudorca</i>						
<i>Feresa</i>	II					
<i>Lissodelphis</i>						
<i>Lagenorhynchus</i>	III?					
<i>Tursiops</i>	III					
<i>Delphinus</i>	III					
<i>Seno</i>						
<i>Stenella</i>						
<i>Sotalia</i>						

THE INSTITUTE OF CETACEAN RESEARCH
 一般財団法人 日本鯨類研究所

living genera. Especially there is no material on RHACHIANECTIDAE and PLATANISTITIDAE. Now, three genera belonged to **MYSTICETI** are all included into Type I, and I guess all species of **MYSTICETI** has Type I corpora accumulation. In other words, we cannot divide **MYSTICETI** more than one group by only the corpora-accumulation curve.

On the contrary, **ODONTOCETI** are able to be divided at least three types by the corpora accumulation. *Physeter*, *Kogia*, *Berardius* and *Ziphius* are included into Type I. And Slijper (1958)'s discription must be added that in **ODONTOCETI**, there are some species of which foetus may develop in either horn. In the way, recently many authors use the same the classification as Fraser (1938), that is, *Physeter* and *Kogia* are classified into PHYSETERIDAE and *Berardius*, *Hyperoodon*, *Ziphius*, *Tasmacetus* and *Mesoplodon* are classified into another family of ZIPHIIDAE. But Flower & Lydekker (1891) and Winge (1918) recognized they are belonged to subfamily of PHYSETERIDAE. And Simpson (1945) established Superfamily PHYSETEROIDEA combining PHYSETERIDAE and ZIPHIIDAE. The phenomena in corpora accumulation will support the taxonomic interrelationship between PHYSETERIDAE and ZIPHIIDAE.

I cannot show the type of corpora accumulation for PLATANISTIDAE. Abel (1913) made special researches on the fossil **CETACEA**, and he tried to determine their position to recent forms. According his genealogical tree, PLATANISTIDAE is included into **SQUALOCETI** with PHYSETERIDAE and ZIPHIIDAE. But Slijper (1936) shows that from primitive SQUALODONTIDAE separate four branches of **ODONTOCETI**, and one of branches becomes to PLATANISTIDAE and PHYSETERIDAE. ZIPHIIDAE become from the second branch and DELPHINIDAE from the third branch. It is very interesting taxonomically that whether corpora accumulation shows Type I or the fourth type in PLATANISTIDAE.

Superfamily **DELPHINOIDEA** classified by Simpson (1945) and family DELPHINIDAE classified by Flower & Lydekker (1891), Winge (1918) and Fraser (1938) etc. does not show Type I. From this point of view, we will understand that so called DELPHINIDAE can be separated phylogenically from **MISTICETI** and **PHYSETEROIDEA**.

However, there are at least two types of species in **DELPHINOIDEA** by the examination on the corpora accumulation rate. That is to say, *Delphinapterus*, *Grampus*, *Globicephala*, *Orcinus*, and *Feresa* show Type II, on the contrary, *Phocaenoides*, *Lagenorhynchus*, *Tursiops*, *Delphinus* and *Stenella* are considered to be included into Type III. Flower & Lydekker (1891) separated DELPHINIDAE into Groups A and B. The species included in Group B show Type III, but in Group A there are two types of corpora accumulation. Winge (1918) describes that DELPHINIDAE is divided into five subfamily; MONODONTES, PHOCAENAE, GLOBICIPITES, LAGENORHYNCHI and DELPHINI, This classification is not contradictory to my result. Fraser (1938)'s classification of subfamily DELPHININAE which is widely used today is considered to be too large as Nishiwaki (1963) reported. Slijper (1936) and Simpson (1945) divided DELEPHININAE by Fraser

(1938) into two families PHOCAENIDAE and DELPHINIDAE but their DELPHINIDAE must be divided at least two kinds from the view point of my typing of corpora accumulation. Recently Nishiwaki (1963, 1964) compared body lengths, number of vertebrae, fused bone in cervical vertebrae, shape of skull, number maxillary teeth and length of rostrum for 12 genera of **ODONTOCETI**, and he separated living **ODONTOSETI** into 10 families as shown in Table 3.

I have no data on the ovaries count for *Orcaella*, *Noeophocaena*, *Phocaena Pseudorca* and *Lissodelphis* and I cannot conclude the typing of corpora accumulation for *Grampus*. Excluding these 7 genera, the typing of corpora accumulation agrees well with Nishiwaki's description. And on the standing point of only corpora accumulation, MONODONTIDAE and GLOBICEPHALIDAE is taxonomically near each other, because they show Type II of corpora accumulation, the other hand, PHOCAENIDAE (PHOCAENEA) and DELPHINIDAE (LAGENORHYNCHI and DELPHINI) show another type of corpora accumulation (Type III). They seem to be somewhat separated taxonomically from MONODONTIDAE and GLOBICEPHALIDAE. But, I consider that the difference between Type II and III is not so substantial as Type I. So, to my opinion, superfamily DELPHINOIDEA is needful for the classification of DELPHINIDAE-type species.

DISCUSSION

In DELPHINIDAE, especially Type III group, left ovary attains at maturity first, and ovulations occur only from the left ovary in young generation, but after the right ovary attains at maturity, ovulations occur more frequently from the right ovary than from the left ovary. Such a phenomenon is interesting for the physiology of reproduction. The mechanism of control for maturity and ovulation in the each ovaries must be studied in future. As morphological approach, distribution of blood vessels and nerves, thickness of coat layer of each ovary and their change according to age should be researched for the settlement of the mechanism.

It is notable that in the males both testes are almost equally mature and the difference of weight between both testes is very slight in the case of DELPHINIDAE so far as I investigated. Then, it is interesting why in the only females maturity and ovulations are different between each sides of ovaries. Ontogenical comparison is needful on the reproductive organs between both sexes for solution of this problem.

The asymmetry of maturity and ovulation in DELPHINIDAE is considered to be related to the asymmetry of skull of **ODONTOCETI**, but PHYSETEROIDEA has same ovulatory pattern as **MYSTICETI** although the skull of it is asymmetry like DELPHINIDAE.

In the previous chapter I discussed the interrelationship between corpora accumulation types and the taxonomic position of **CETACEA**, and I found ovulatory pattern is related with the taxonomic status of the animals. Johnson & Ostenson (1959) describes that "modern taxonomic studies on specific and above must be based on more than simple morphologic comparison when complex relationships

are involved. Further research into their biologic nature is necessary". And they showed several taxonomic methods. As one of modern morphologic comparisons, they showed the genital tracts and foetal membranes reported by Mossman (1953). I believe in fact that the total biologic relationship and not any single taxonomic criterion is important as Johnson & Ostenson described. And the comparison of corpora-accumulation rate will be useful as one of the taxonomic criteria. For this purpose, we must gather more material on all species. Especially we have no or very small materials on PLATANISTIDAE and PHOCAENIDAE. I must say that comparison of corpora accumulation is only one method of taxonomical approaches and many other biological relationships are needful for the complete attainment to truth.

SUMMARY

1. Comparison of maturity and accumulation of corpora between the left and right ovaries is studied for 23 species of **CETACEA**.

2. Accumulation curves of **CETACEA** so far as investigated are classified into three kinds of types.

3. Type I: Maturity and ovulation occurs from both ovaries equally. Following species are considered to be included in this kind of type:

Balaenoptera musculus, *B. physalus*, *B. edeni*, *B. borealis*, *B. acutorostrata*, *Megaptera novaeangliae*, *Eubalaena glacialis*, *Physeter catodon*, *Kogia* sp. *Berardius bairdii* and *Ziphius cavirostris*.

4. Type II: Corpora accumulation in the left ovary is rather more than the right in young stage. But the difference between both ovaries is not so much. Following species are considered to be included in Type II:

Delphinapterus leucus, *Grampus griseus*, *Globicephala melaena*, *G. scammoni*, *Orcinus orca* and *Feresa attenuata*.

5. Type III: For relatively long time, ovulation occurs only from the left ovary, but after attainment of maturity of the right ovary, corpora accumulation of the right ovary becomes more frequently than the left. Following species are included into this type: *Phocaenoides dalli*, *Lagenorhynchus obliquidens*, *Tursiops truncatus*, *Delphinus delphis*, *Stenella attenuata*, and *S. caeruleoalba*.

6. As regards the percentage of distribution of corpora in the left ovary, range and average values of above three types are counted as follows:

	Range (%)	Average (%)
Type I	45-55	52.0
Type II	58-83	65.6
Type III	82-100	92.7

7. Corpora accumulation in **MYSTICETI** and **PHYSETEROIDAE** is classified into Type I. On the contrary, **DEPHINIDAE** *seusu lato* shows other types, and they should be separated into at least two classification by consideration of corpora-accumulation types.

REFERENCES

- Abel, O. (1913). Die Vorfahren der Bartenwale. *Denskscher. K. Akad. Wiss. Wein. Math-naturwiss. Kl.* 90: 155-224
- Andrews, F. N. & McKenzie, F. (1941). *Mo. Agric. Exp. Sta., Rec. Bull.* 329 (Cited from Asdell, 1946)
- Asdell, S. A. (1946). *Patterns of mammalian reproduction.* 437 p. Comstock Pub. Co., New York.
- Flower, W. H. & Lydekker, R. (1891). *An introduction to the study of mammals living and extinct.* 763 pp. Adam and Charles Black, London.
- Flynn, T. T. & Hill, J. P. (1938). *Trans. Zool. Soc. London* 24: 445 (Cited from Asdell, 1946).
- Fraser, F. C. (1937). (See Norman, J. R. & Fraser, F. C.)
- Henning, W. L. (1939). *J. Agric. Res.* 58: 565-80 (Cited from Asdell, 1946).
- Johnson, M. L. & Ostenson, B. T. (1959). Comments on the nomenclature of some mammals of Pacific Northwest. *J. Mamm.* 40: 571-7.
- Kenyon, K. W. (1961). Cuvier beaked whales stranded in the Aleutian Island. *J. Mamm.* 42: 71-8.
- Laws, R. M. (1961). Reproduction, growth and age of southern fin whales. *Discovery Repts.* 31: 337-486.
- Matthews, L. H. (1938). Notes on the southern right whale, *Eubalaena australis*. *Discovery Repts.* 17: 169-82.
- Mossman, H. W. (1953). The genital system and foetal membranes as criteria for mammalian phylogeny and taxonomy. *J. Mamm.* 34: 289-98.
- Nishiwaki, M. (1963). Taxonomical consideration on Genera of Delphinidae. *Sci. Rep. Whales Res. Inst.* 17: 93-103.
- (1964). Revision of the article "Taxonomical consideration on genera of Delphinidae" in No. 17. *Sci. Rep. Whales Res. Inst.* No. 18: 171-2.
- Norman, J. R. & Fraser, F. C. (1937). *Giant fishes, whals and dolphins.*, 361 pp. Putnam, London.
- Ogawa, T. (1936-37). Studies on the Odontoceti in Japan. *Plants and Animals* 4(7)-5(3). (in Japanese).
- Omura, H. (1958). North Pacific right whales. *Sci. Rep. Whales Res. Inst.* 13: 1-52.
- Reece, R. P. & Turner, C. W. (1938). *J. Dairy Sci.* 21: 37-9. (Cited from Asdell, 1946)
- Sergeant, D. E. (1962). The biology of the pilot or pothead whale, *Globicephala malaena* (Traill) in Newfoundland waters. *Bull. Fish. Res. Board Canada.* 132: 84 p.
- Simpson, G. G. (1945). The principles of classification and a classification of mammals. *Bull. Amer. Mus. Nat. Hist.* 85: 350 pp.
- Sleptsov, M. H. (1940). *Zool. Zhurnal.* 19: 297 (Cited from Slijper, 1949).
- Slijper, E. J. (1936). Die Cetaceen, Vergleichend-anatomisch und Systematisch. *Capita Zool.* 7: 1-590.
- (1949). On some phenomena concerning pregnancy and parturition of the cetacea. *Bijdr. Dierk.* 28: 416-46.
- (1958). *Walvissen* (Translated by Pomerans, A. J. into English. Hutchinson, London, 1962. 475 p.)
- Warwick, L. (1926). *Anat. Rec.* 33: 29-33 (Cited from Asdell 1946).
- Winge, H. (1918). A review of the interrelationships of the Cetacea. *Vidensk Medd. Nat. Foren. Bd.* 70. (Translated by Miller, Jr. G. S. in *Interrelationships of the Mammalian genera III.* 222-302, 1942).

APPENDIX. RELATION OF THE NUMBER OF CORPORA BETWEEN THE
BOTH OVARIES AND THE LEFT OVARY

B: Number of corpora in the both ovaries.

L: Number of corpora in the left ovary.

TABLE 1. BALAENOPTERA MUSCULUS

L\B	1	2	3	4	5	6	7	8	9	10	11	12	13	Total
0	2	2												4
1	5	1	2	3	—	1								12
2		1	1	7	2	1	1	2	1					16
3			—	1	2	—	1	2	2					8
4				—	—	3	1	2	—	—	2			8
5					—	—	—	1	2					3
6						—	1	—	—	—	—	1	1	3
7							—	—	1	—	—	—	1	2
8								—	—	—	1	—	—	1
Total	7	4	3	11	4	5	4	7	6	—	3	1	2	57

TABLE 2. BALAENOPTERA EDENI

L\B	1	2	3	4	5	6	7	8	9	10	11	12	13	14	15	Total
0	2	1	2													6
1	3	6	5	1	1											16
2		1	—	3	1	1	—	1								7
3			1	4	1	—	1	—	1	1	—	—	1			10
4					1	1	—	—	1	—	—	—	—	1		4
5						1	—	—	—	—	1					2
6							1	—	1	—	—	1	—	1		4
7								1	—	—	—	—	1	—	1	3
8													1	1		2
Total	6	8	8	8	4	3	2	2	3	1	1	1	3	3	1	54

TABLE 3. BALAENOPTERA BOREALIS

L\B	1	2	3	4	5	6	7	8	9	10	11	12	13	14	15	16	17	18	19	20	Total
0	1	2	1	1																	5
1	2	1	2	—	2	—	1														8
2		2	4																		6
3			1	1	3	—	2	2	4												13
4					1	—	1	3	5	3	1	1									15
5							1	2	2	—	1	—	2								8
6								2	1	—	2	2	1	1	—	1					10
7												2	1								3
8											1	1	—	—	—	—	1	—	1		4
9														1	—	1	1	—	—	1	4
10															1	—	1	—	1		3
11																					—
12																				1	1
Total	3	5	8	2	6	—	5	9	12	3	4	6	5	2	1	2	3	—	3	1	80

TABLE 4. BALAENOPTERA PHYSALUS

L\B	1	2	3	4	5	6	7	8	9	10	11	12	13	14	15	16	17	18	18	20	21	22	23	24	25	26	27	28	29	30	35	47	69	Total	
0	12	8	1																															21	
1	21	24	19	7	5	2	1	--	--	1																								80	
2	8	12	15	6	7	3	1																											52	
3	6	8	9	5	2	2	5	--	1	--	--	1	1																					40	
4	2	3	3	9	3	4	--	1	1	1																								27	
5	2	--	2	5	3	1	4	3	2																									22	
6	2	--	2	1	3	--	1	3	--	1	--	1	--	1	--	--	1																	10	
7	1	1	--	1	2	--	1	--	--	1	--	--	--	--	--	--	--	--	1															7	
8	1			1	--	2	3	4	--	1	--	1	--	1	--	1	--	1																12	
9	1	1	3	--	1	1	3	--	1	--	1	--	1	--	1	--	1																	7	
10	1			1	--	1	1	--	1	--	1	--	1	--	1	--	1																	5	
11	1			1	--	1	1	--	1	--	1	--	1	--	1	--	1																	3	
12	1			1	--	1	1	--	1	--	1	--	1	--	1	--	1																	4	
13																																			--
14																																			1
15																																			1
16																																			1
17																																			--
18																																			2
19																																			1
35																																			1
Total	33	40	38	32	25	17	17	14	14	3	11	11	9	5	4	2	4	3	2	3	2	--	3	--	1	1	1	2	--	1	1	1	1	297	

TABLE 5. MEGAPTERA NOVAEANGLIAE

L\B	1	2	3	4	5	6	7	8	9	10	11	12	13	Total
0	9	2	1	1										13
1	13	11	5	3	1									33
2		7	7	2	4	1	1							22
3			2	5	3	4	2	—	1					17
4					2	3	2							7
5							2	—	2	—	—	1	1	6
6										1	1			2
Total	22	20	15	11	10	8	7	—	3	1	1	1	1	100

TABLE 6. PHYSETER CATODON

L\B	1	2	3	4	5	6	7	8	9	10	11	12	13	14	15	16	17	24	25	37	Total	
0	7	5	2	2																		16
1	12	16	16	7	1	1																53
2		5	26	26	13	6	5															81
3			4	11	11	7	11	6	7													57
4				2	3	8	5	7	4	2	2	1										34
5						2	2	5	3	4	1	2	—	—	—	—	1					20
6							2	1	1	2	1	5	2									14
7									1	1	1	—	2	2	2							9
8									1	—	1	—	—	1	1	1						5
9													2	1	2							5
10										1												1
11																						—
12																			1			1
13																		1				1
20																				1		1
Total	19	26	48	48	28	24	25	19	17	9	7	8	6	4	5	1	1	1	1	1	1	298

TABLE 7. GLOBICEPHALA MELAENA

L\B	1	2	3	4	5	6	7	8	9	10	11	12	13	14	Total
0	3	1	1	2	—	—	—	1							8
1	20	6	2	3	—	1	1								33
2		5	17	3	—	—	1								26
3			10	4	7	2	2	1	2						28
4				6	3	2	3	—	3						17
5					6	6	6	3	3	2	1		1		27
6							3	6	4	4	1	2	1		21
7							1	1	—	1	—	1			5
8												3			3
9									1	1					2
10													1	1	2
11															—
12													1		1
Total	23	12	30	18	16	11	17	12	13	8	2	6	4	1	173

TABLE 8. STENELLA CAERULEOALBA

LAB	1	2	3	4	5	6	7	8	9	10	11	12	13	14	15	16	17	18	19	20	21	Total
0																						—
1	33	1																				34
2		38	—	1																		39
3			44	1	1																	46
4				38	1																	39
5					41	1	1															43
6						24	2	3	—	1	—	1										31
7							19	1	—	—	—	—	—	—	1							21
8								19	—	—	2	1										22
9									14	1	—	—	1	—	1							17
10										10	2	1	—	1	2	—	1					17
11											5	1	—	—	—	2	—	1				9
12												4	1	—	—	—	—	1				6
13													2	1	—	—	—	—	1			4
14														2	1							3
15																						—
16																	1	—	—	—	1	2
Total	33	39	44	40	43	25	22	23	14	12	9	8	4	4	4	3	2	2	1	—	1	333

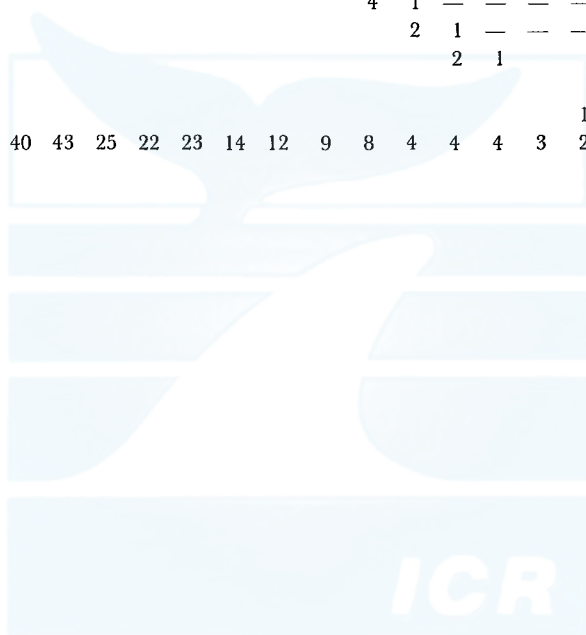

一般財団法人 日本鯨類研究所
THE INSTITUTE OF CETACEAN RESEARCH

EXPLANATION OF PLATE

Left side shows the left ovary and the right side shows right ovary in each figure. Numbers of corpora are shown as follows ; a-b : a is the number of corpora lutea, and b is the number of corpora albicantia.

- A: *Balaenoptera physolus*, L: 0-6, R: 0-9 (×0.17)
B: *Physeter catodon*, L: 0-3, R: 0-2 (×0.33)
C: *Kogia sp.*, L: 0-6, R: 0-7 (×1.1)
D: *Feresa attenuata*, L: 0-3, R: 0-1 (×1.1)
E: *Phocaenoides dalli*, L: 1-1, R: 0-0 (×1.3)
F: *Stenella caeruleoalba*, L: 0-2, R: 0-0 (×1.4)



一般財団法人 日本鯨類研究所
THE INSTITUTE OF CETACEAN RESEARCH



A

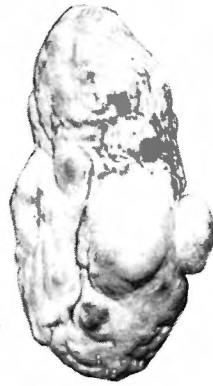

B



C



D



E



F

一般財団法人 日本鯨類研究所
THE INSTITUTE OF CETACEAN RESEARCH

A SYSTEMATIC STUDY OF THE HYOID BONES IN THE BALEEN WHALES

HIDEO OMURA

The hyoid bone is accepted as having characteristics which can be used as a taxonomic criterion in the terrestrial mammals (Sprague, 1941; Johnson & Ostenson, 1959). But in the whales it seems that no special importance has been placed on the hyoid bone for systematic studies. It is of interest, therefore, to know taxonomic characteristics of the hyoid bone of the whales. Further in whales, especially in larger cetaceans, it is very difficult to collect a reasonable numbers of skeleton to treat them quantitatively. Accordingly it is also difficult to ascertain whether the differences noted are the individual one or those between subspecies, species or genera.

Hyoid bone is without great difficulty be collected even in the larger whales. In the last four years I could collect them from a total of more than 100 baleen whales, excepting grey, greenland, and pigmy right whales. These were gathered from the Antarctic, Bering Sea and its neighbouring waters, and coast of Japan by my colleague in the Whales Research Institute with assistance of personnel of the whaling companies concerned.

In the present paper these hyoid bones were treated statistically from the viewpoint of the taxonomy.

MATERIAL

The material treated in this study are shown in Table 1.

TABLE 1. NUMBER OF WHALES FROM WHICH HYOID BONE WAS COLLECTED

Species	Locality	Year	Number	Average body length ⁵⁾	Abbreviation
Blue whale <i>Balaenoptera musculus</i>	Antarctic ¹⁾	1961	9	21.77	BmA
Fin whale <i>B. physalus</i>	Antarctic	1961	10	21.00	BpA
" " " "	Bering Sea ²⁾	1960	13	19.16	BpB
Sei whale <i>B. borealis</i>	Antarctic	1961	9	15.27	BbA
" " " "	Coast, Japan	1960	10	13.21	BbC
Bryde's whale <i>B. edeni</i>	Coast, Japan	1960, 62	22 ³⁾	13.05	BeC
Minke whale <i>B. acutorostrata</i>	Coast, Japan	1962	11	6.24	BaC
Humpback whale <i>Megaptera novaeangliae</i>	Bering Sea ²⁾	1962	4	13.50	MnB
" " " "	Coast, Okinawa	1961	9 ⁴⁾	11.40	MnB
Black right whale <i>Eubalaena glacialis</i>	Bering Sea ²⁾	1062, 63	5	15.28	EgB

- 1) Pigmy blue whale. 2) Includes its nearby waters. 3) In which 7 samples lacking stylohyals.
4) Not complete sets. 5) In meter.

As shown in Table 1 the hyoid bones have been collected from seven species i.e. from blue, fin, sei, Bryde's, minke, humpback, and black right whales. In order to investigate intra-specific differences samples of some species have been gathered from different localities. My first intention was that to collect each ten

samples from different species and from different localities for a preliminary study. This has not been completed.

For the blue whale samples were only collected from the pigmy blue whale in the Antarctic. Ichihara (1961, 1963) separates the pigmy blue whale from the ordinary blue whale in the Antarctic. His conclusion is mainly based on the external characters. It is of great interest, therefore, to examine the difference in the hyoid bones between the two groups. But this is not possible in the present paper.

For the humpback whale samples were collected from the Bering Sea and its nearby waters as well as from the waters around Okinawa Islands. But in the former only four samples were collected. From the latter waters a good number were collected, but during the course of transportation these bones were damaged and only parts of them are available for comparison. The results of whale marking suggest that the two stocks are belong to a single population. They are treated in this paper for the time being as a whole accordingly.

For the black right whale I have two additional samples. In 1961 two skeletons of this species have been secured from the same locality, but they are not available for the present study, because they are still burried in the earth for extraction of oil contained in them.

Further it is interesting to compare the hyoid bones of fin whale from the East China Sea to those from other localities, but this was impossible. The whaling operation in that area has been stopped since 1961. I could not collect any sample from the grey whale, *Eschrichtius gibbosus*.

In osteological study of such nature it is very important to compare samples of similar age and preferably those of physically matured animals. But as a matter of fact this was very difficult. If the samples are selected only from the physically matured animals, then the sample number will be reduced considerably and they cannot be treated statistically. In the present study, therefore, I used hyoid bones from animals which already attained sexual maturity or in the state of puberty in principle. Samples from animals younger than these have also been collected in some species, but these were not used in the present study from the above reason. For the minke and humpback (from Okinawa) whales, however, this principle was not applied. They include sexually immature animals because of difficulty in gathering samples. Especially in the case of the minke whale the hyoid bones were obtained mostly from the immature whales. The average body lengths of the whales from which the hyoid bones were collected and used in the present study are also shown in Table 1 and in detail in Appendix 1.

The present paper, under circumstances mentioned above, is of preliminary nature and it should be supplemented or revised in future when more samples are collected.

GENERAL DESCRIPTION

(Plates I-XV)

The hyoid bones of baleen whales are consisted of three separate bones i.e. one

combined bone of basihyal and thyrohyals, and two stylohyals. In general the basihyal and thyrohyals are united completely and no suture between them is visible. Omura (1958) reports that in his Ayukawa specimen of the black right whale the basihyal and thyrohyals are not ankylosed into a mass and in his specimen from Kiritappu of the same species the sutures were still visible, though the bones were united completely. They were both sexually immature and the body length of these whales were 11.65 and 12.40 meters respectively. Omura (1957) also reports that his specimen of minke whale (7.50 meter long) had a combined basihyal and thyrohyals in which two shallow notches were present, in addition to the median notch, on the anterior margin of the bone, on the borders of basihyal and thyrohyals. In the hyoid bones used for the present study none of such facts was observed. The basihyal and thyrohyals are united completely into a mass and no suture between them is visible. The smallest black right whale in the present study is 14.10 meter in length. This is much larger than the Ayukawa and Kiritappu specimens. This whale was a female and it had no corpus luteum and c. albicans in its ovaries, but contained in one of the ovaries a ripening follicle. Also in this specimen no suture was visible (Plate XV Fig. 1). It is suggested, therefore, from the above facts that in the black right whale the basihyal and thyrohyals are separated in younger stages as in the case of the toothed whales, but they unite completely before the whale reach puberty.

For the minke whale all of the samples except two were collected from smaller animals than 7.50 meter, but none of them had any additional notch on the anterior margin of the combined bone of basihyal and thyrohyals, except the median notch. It is possible, therefore, that the case of the presence of the two additional notches, as reported by him, is the exceptional one. In the samples from the sei and Bryde's whales, which had not been used in the present study because of immature, also no additional notch is present.

The ankylosed bone of basihyal and thyrohyals is wing-like shape in general. The central portion (basihyal) is dorso-ventrally compressed and has two anterior projections, forming a median notch. The length of the anterior projections is different individually, but in general they are short in the black right and hump-back whales and long in whales which belong to genus *Balaenoptera*. I have no specimen from the grey whale, but according to Andrews (1914) they are also short.

In the central portion there also present a pair of projections on the posterior side. These posterior projections are rounded in general, but subject to heavy individual variation. In some specimens they are prominent, but in another specimens they are less prominent and in the extreme case they are jointly forming one roundish median projection. Such cases are observed in the sei and Bryde's whales (Plate VI, Figs. 5, 6, Plate X, Fig. 3, Plate XI, Figs. 1, 8, 10). In the minke whale the posterior projection present as single roundish median projection or less developed (Plate XIII).

The wing portion (thyrohyals) thickens towards the distal ends in general and in the black right whale it becomes nearly cylindrical, but in the sei, Bryde's and minke whales they are rather flat. In the blue whale it increases its thickness

rapidly, but it also increases its breadth in the mid-length. The both distal ends are narrow and thin in the whales belong to the genus *Balaenoptera*, but very massive in the black right whale. In the humpback whale they are more massive than those of the genus *Balaenoptera*, but in lesser degree than in the black right whale.

The ankylosed bone of basihyal and thyrohyals is concave from the dorsal aspect, but the degree of the curvature is seemed more individual than specific, excepting the black right whale in which the bone is nearly straight on the ventral surface. I have used, therefore, the overall length along the outer surface and passing the center of the basihyal as the length of the bone, instead of the straight length between the two distal ends. The overall lengths of the combined bones are generally between five and seven per cent of the body lengths of the whales. No significant difference according to species is noted among these percentages.

The stylohyals are flat in the whales of the genus *Balaenoptera*. Also in the humpback whales they are rather flat, but those of the black right whale are quite different from other species. They are nearly cylindrical and somewhat constricted in the one-thirds portion from the proximal ends. In one occasion among four, however, no such constriction is observed (Plate XV, Fig. 8). In this sample the ventral view of the stylohyal resembles more closely to that of the humpback whale and rather flat in general. But it thickens suddenly towards the distal end and approaches to cylinder.

The stylohyals of the fin, minke, and humpback whales are narrower than those of the blue, sei, and Bryde's whales. But in the fin whale, in some specimens they are broader than the other and very difficult to identify them from those of the blue and sei whales (Plate III Lower, Fig. 3, Plate V, Fig. 7). In the sei whale the stylohyals are much curved forwards and in the Bryde's whale they are less curved and more slender, but there present some exceptional cases (Plate VII, Fig. 2, Plate XII, Fig. 14).

The surface of the hyoid bones, both the combined bone of basihyal and thyrohyals and the stylohyals, are generally smooth in most species. In the humpback whale, however, they are rugose bones. In the blue and fin whales the anterior and posterior projections are more or less corrugated, but in lesser degree than in the humpback whale. Andrews (1914) reports that the hyoid bone of the grey whale is extremely massive and rugose bone. He also describes that the shape of the thyrohyal portion of the combined bone resembles to that of *Eubalaena* and his photograph supports this, but in the present samples from the black right whale the surface of the bone is very smooth. It is suggested, therefore, the rugose hyoid bone is a specific character of the humpback and grey whales.

MEASUREMENTS

The following measurements were made on each hyoid bone collected (see Fig. 1).

A. Ankylosed bone of basihyal and thyrohyals.

- a. *Overall length.* This was measured between the tips of the wings (thyrohyals) by a curved line, running along the outer surface of the bone and passing the

center of the basihyal.

- b. *Straight length.* This was measured by a straight line between the tips of the wings, disregarding the curvature of the bone. This length was only used for checking.

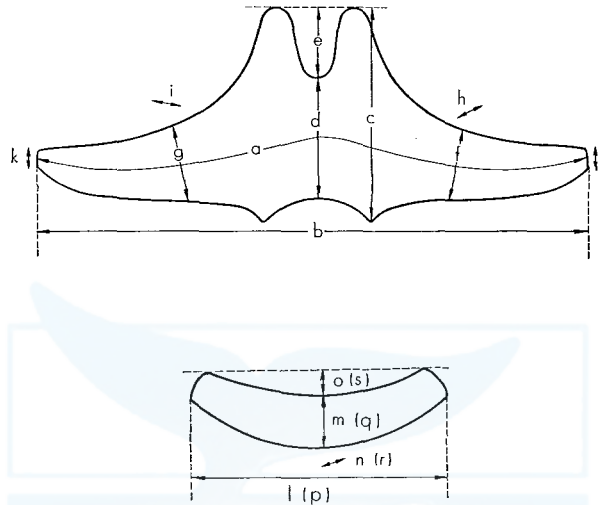

Fig. 1. Showing positions of the measurements.

- c. *Greatest height.* Greatest height between tips of the anterior and posterior projections of the basihyal.
- d. *Height at center.* Height measured at the center of the bone.
- e. *Forward notch, depth.* Depth of the notch between the pair of forward projections of the basihyal.
- f. *Height at middle of the wing, right.* Height measured at middle between the center of the basihyal and the tip of the right wing.
- g. *Height at middle of the wing, left.* Height measured at middle between the center of the basihyal and tip of the left wing.
- h. *Thickness at middle of the wing, right.* Thickness of the right thyrohyal on the line of the measurement f.
- i. *Thickness at middle of the wing, left.* Thickness of the left thyrohyal on the line of the measurement g.
- j. *Height at distal end, right.* Height of right thyrohyal at its distal end.
- k. *Height at distal end, left.* Height of left thyrohyal at its distal end.
- B. Styohyal
- l. *Total length, right.* Length measured by a straight line between the tips of the right stylohyal.
- m. *Height at middle, right.* Height at middle of the right stylohyal.
- n. *Thickness at middle, right.* Thickness of the right stylohyal measured on the line of the measurement m.

- o. *Degree of curvature, right.* Greatest distance between the straight line which pass the most prominent parts of the right stylohyal and its forward surface.
- p. *Total length, left.* Corresponding measurement of l of the left stylohyal.
- q. *Height at middle, left.* Corresponding measurement of m of the left stylohyal.
- r. *Thickness at middle, left.* Corresponding measurement of n of the left stylohyal.
- s. *Degree of curvature, left.* Corresponding measurement of o of the left stylohyal.

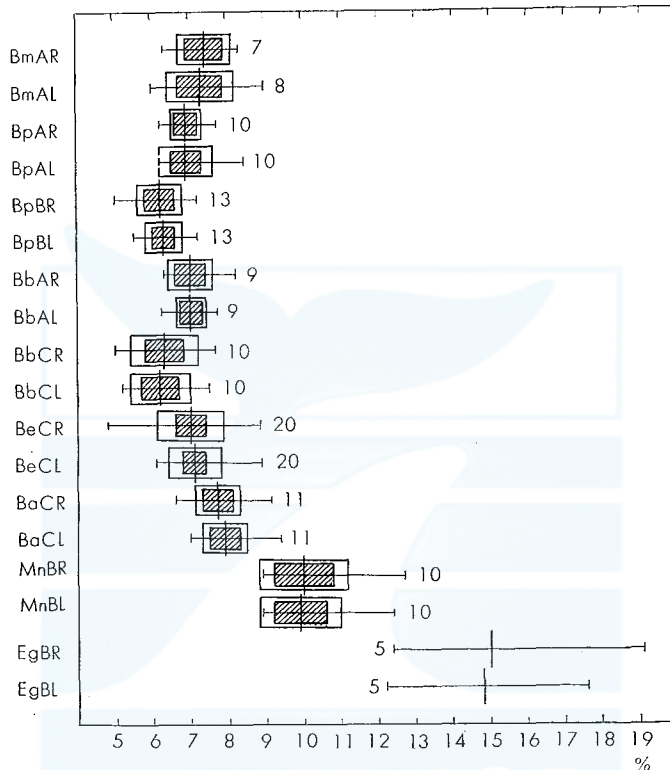

Fig. 2. Combined bone of basihyal and thyrohyals.

Proportional height at distal ends against overall length.

The horizontal line represents the ranges; the vertical midline the arithmetic mean; the outer box one standard deviation on either side of the mean; the inner box two standard errors on either side of the mean; the figures are the sample numbers.

See Table 1 for explanation of abbreviation. R and L attached mean the right and left sides respectively.

Above measurements were then calculated of their percentages against the overall length in the case of the combined bone of the basihyal and thyrohyals. For the stylohyals also were calculated percentages of their length against the overall length of the combined bones, but their heights, thickness and the degree of curvature were calculated as the percentages of the total length of the stylohyals. Further for each measurement the arithmetic mean, standard deviation and the two standard errors were calculated. The results are shown in Figs. 2-11, together with the ranges

of the value. The details of the measurements are shown in Appendix 1 and the results of the calculations in Appendix 2.

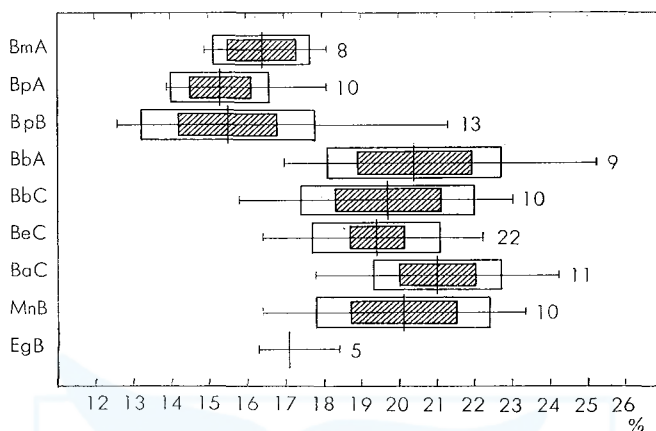

Fig. 3. Combined bone of basihyal and thyrohyals. Proportional height at center against overall length. See Fig. 2 for explanation.

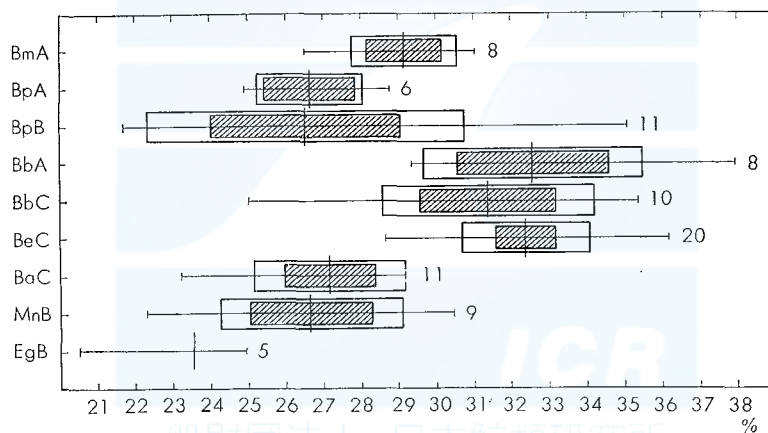

Fig. 4. Combined bone of basihyal and thyrohyals. Proportional height (greatest) against overall length. See Fig. 2 for explanation.

A. *The combined bone of basihyal and thyrohyals.*

1. *Proportional height at distal ends* (Fig. 2). As seen in Fig. 2 the whales are divided into three groups in this character. The blue, fin, sei, Bryde's and minke whales (genus *Balaenoptera*) are all belong to one group. The humpback whale (genus *Megaptera*) are separated significantly from this group. It is highly possible that the black right whale (genus *Eubalaena*) is distinct from the above two groups, though the sample number is fewer than any other

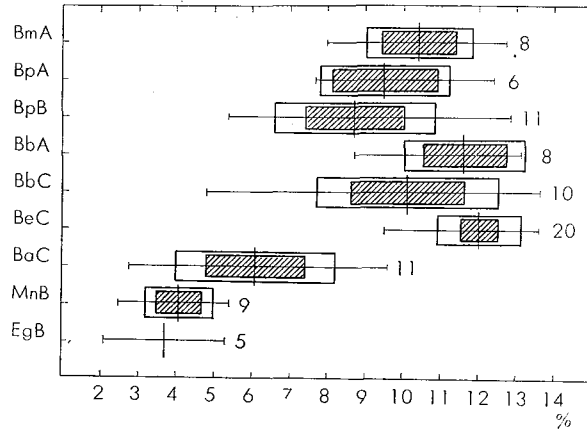

Fig. 5. Combined bone of basihyal and thyrohyals.
Proportional depth of forward notch against overall length.
See Fig. 2 for explanation.

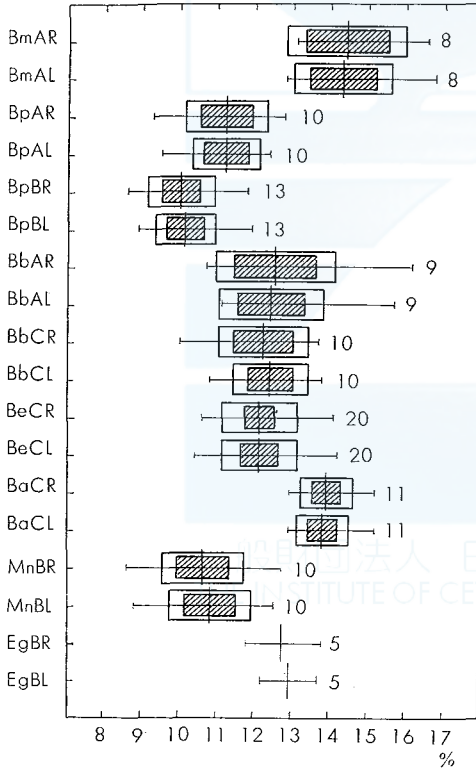

Fig. 6. Combined bone of basihyal and thyrohyals.
Proportional height at middle of the wing against overall length.
See Fig. 2 for explanation.

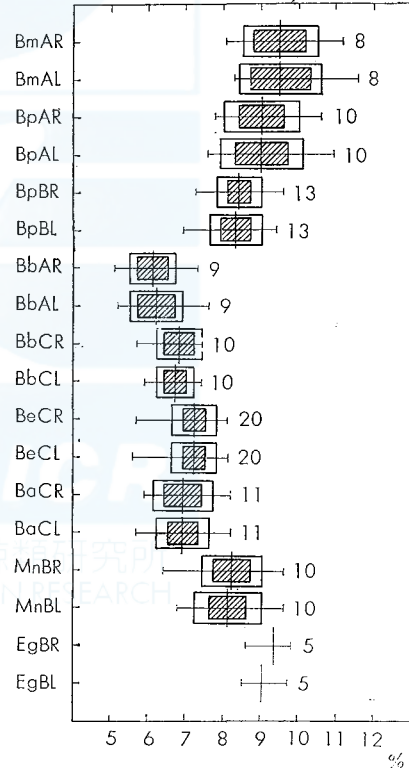

Fig. 7. Combined bone of basihyal and thyrohyals.
Proportional thickness at middle of the wing against overall length.
See Fig. 2 for explanation.

species. In the fin and sei whales, those from the Antarctic show somewhat different value of the arithmetic mean from those from the Bering Sea or the coast of Japan, but they cannot be separated, because the two standard errors are overlapping each other. In other words neither racial nor subspecific difference is noted within the same species. But there is a significant difference between the minke whale from the coast of Japan (BaC) and the sei whale from the same locality (BbC), though no difference is present between the

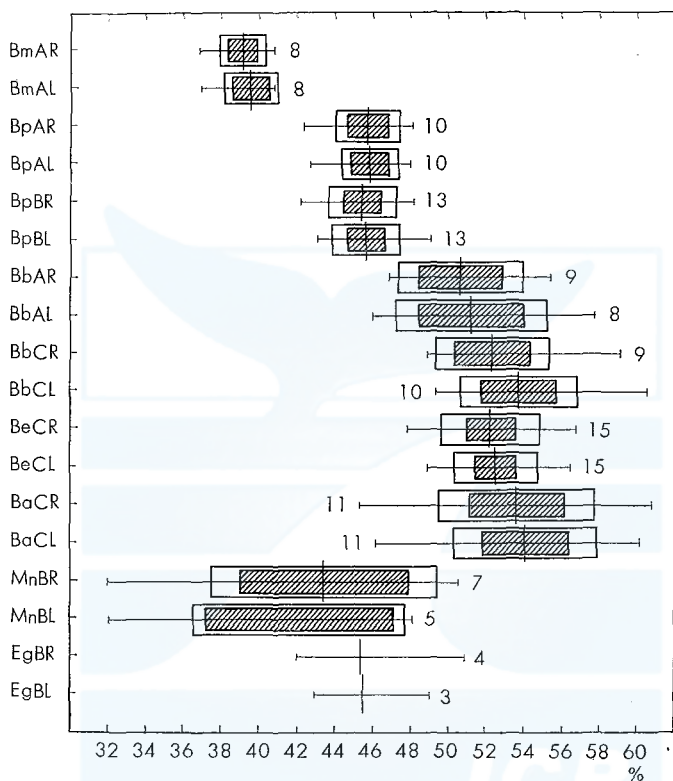

Fig. 8. Stylohyals. Proportional length of stylohyals against the overall length of the combined bone. See Fig. 2 for explanation.

former and the sei whale from the Antarctic (BbA). The same is applied also to the fin whale. In general no significant difference is noted in this character among the species of the genus *Balaenoptera*.

The values for the right and left sides are coincide fairly well in each species.

2. *Proportional height at center* (Fig. 3). In this character the whales are divided into two groups. The blue and fin whales are belong to the same group and the sei, Bryde's, minke and humpback whales to the another. The black right whale is probably be included in the former group. No difference is noted in the fin and sei whales between those from different localities.

3. *Proportional height (greatest)* (Fig. 4). In this character all species except the blue whale are grouped into two. The fin, minke, humpback and black right whales are belong to one group and the sei and Bryde's whales to the another. Also in this character no difference is noted in the fin and sei whales between whale stocks in different localities.

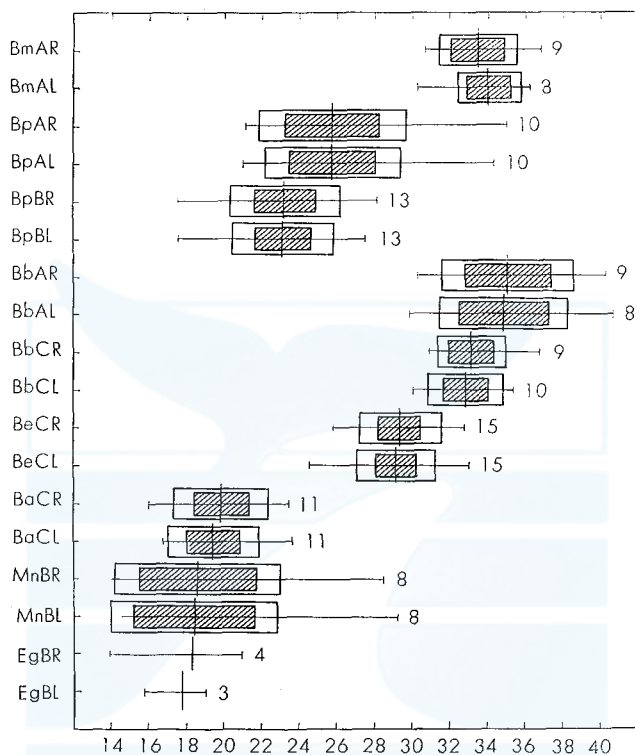

Fig. 9. Stylohyals. Proportional height at middle against its length.
See Fig. 2 for explanation.

4. *Proportional depth of forward notch* (Fig. 5). In this character the humpback and black right whales are forming one group, distinctly different from the blue, fin, sei and Bryde's whales. In other words the forward projections are generally much longer in the genus *Balaenoptera* than *Megaptera* and *Eubalaena*. One exception of this is the minke whale. It has much shorter forward projections than any other species of that genus. It should be reminded, however, that the samples from the minke whale were mostly collected from the immature whales as stated before.
5. *Proportional height at middle of the wing* (Fig. 6). In this character there can be noted two distinct groups and one overlapping group. The blue and minke whales belong to one group and the fin and humpback whales to the another. The other species i.e. the sei, Bryde's and black right whales are over-

lapping to these groups. I cannot separate the fin whales in the Antarctic from those from the Bering Sea. The two standard errors are overlapping each other, though very slightly. But probably they can be separated when more samples are collected in future. The blue whale is distinctly separated from the fin whale in this character. No difference is noted between right and left sides in each species.

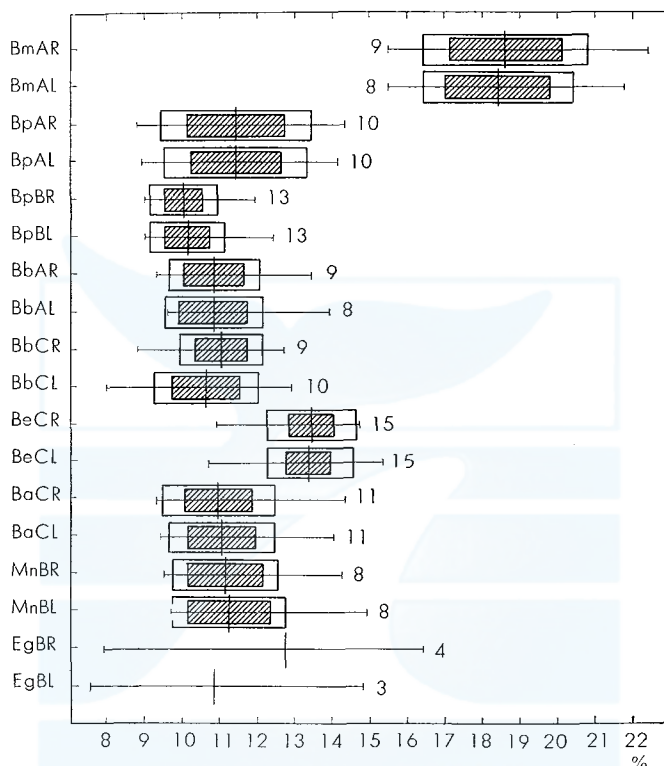

Fig. 10. Stylohyals. Proportional thickness at middle against its length. See Fig. 2 for explanation.

6. *Proportional thickness at middle of the wing* (Fig. 7). In this character the genus *Balaenoptera* is divided into two groups. The blue and fin whales belong to one group and the other species to the another. The humpback and black right whales are also belong to the former group. But this character might be of little value for comparison of the genera. In the genus *Balaenoptera* the thickness is usually the greatest towards the middle of the wing, whereas in the genus *Megaptera* and *Eubalaena* the distal end is the thickest.

B. Stylohyals

7. *Proportional length of stylohyals* (Fig. 8). The genus *Balaenoptera* is divided into three groups in this character. The blue whale has the shortest stylohyals, the

fin whales comes next, and the sei, Bryde's and minke whales have longer stylohyals than other species. The humpback whale has wider ranges of variation and they are overlapping to the values for the blue and fin whales. The black right whale seems to have little longer stylohyals than the humpback whale. No difference is noted between the right and left sides. No difference is also observed in the fin and sei whales between those from different localities.

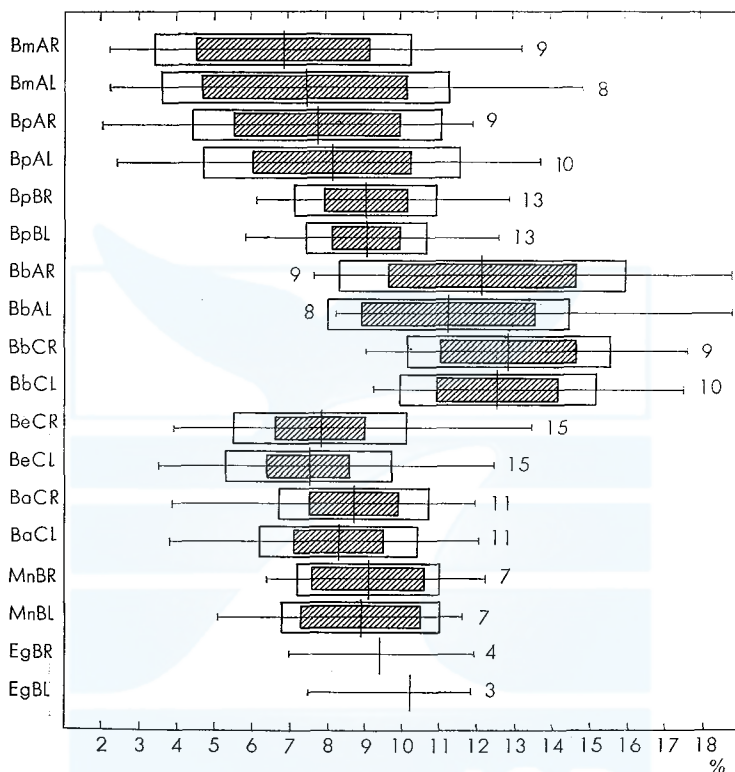

Fig. 11. Stylohyals. Degree of curvature.

See text and Fig. 2 for explanation.

8. *Proportional height at middle* (Fig. 9). In this character all whale species except the Bryde's whale are classified into two groups. The blue and sei whales have broader stylohyals than other species. The Bryde's whale has a greater value than fin whale, but they are still separated from the sei whale in this character. Again no difference is noted between the right and left stylohyals and between those from different localities within the same species.
9. *Proportional thickness at middle* (Fig. 10). As seen in Fig. 10 the blue whale has thicker stylohyals proportionally than any other species. It should be noted that the Bryde's whale is separated from the sei whale in this character too.

10. *Degree of curvature* (Fig. 11). The stylohyals are usually curved forwards and the degree of the curvature was expressed as percentage of the length stated already (measurements o and s) against the length of the stylohyal. Rather wide ranges of variation are observed in each species. The Bryde's whale is separated from the sei whale from the coast of Japan, but the two standard errors are very slightly overlapping to that of the sei whale in the Antarctic. It seems that this character is of less importance in other species.

CONCLUSION

In Table 2 the results of the measurements are summarized briefly. As seen in this table most whale species, from which the hyoid bones were collected, are separated from each other by the combined bone of basihyal and thyrohyals. One exception of this is the distinction of the Bryde's whale from the sei whale. The combined bone of basihyal and thyrohyals of the both species resembles each other very closely and they cannot be identified by this bone. But in the stylohyals the Bryde's whale is separated from the sei whale, having less broader, much thicker and less forwardly curved stylohyals. As already noted, however, there

TABLE 2. SUMMARY OF COMPARISON

Items	Species and locality								
	BmA	BpA	BpB	BbA	BbC	BeC	BaC	MnB	EgB
A. Combined bone of basihyal and thyrohyals									
1. Proportional height at distal ends	0	0	0	0	0	0	0	Δ	X
2. Proportional height at center	0	0	0	Δ	Δ	Δ	Δ	Δ	0?
3. Proportional height (greatest).....	0Δ	0	0	Δ	Δ	Δ	0	0	0
4. Proportional depth of forward notch.....	0	0	0	0	0	0	0Δ	Δ	Δ
5. Proportional height at middle of wing ...	0	Δ	Δ	0Δ	0Δ	0Δ	0	Δ	0Δ
6. Proportional thickness at middle of wing	0	0	0	Δ	Δ	Δ	Δ	0?	0
B. Stylohyals									
7. Proportional length of stylohyals.....	0	Δ	Δ	X	X	X	X	0Δ	ΔX
8. Proportional height at middle.....	0	Δ	Δ	X	X	Δ	Δ	Δ	Δ
9. Proportional thickness at middle.....	0	Δ	Δ	Δ	Δ	Δ	Δ	Δ	Δ
10. Degree of curvature	0	0	0	0Δ	Δ	0	0	0Δ	0Δ

See Table 1 for species and locality.

0, Δ, X, showing groups of species of similar value.

are some exceptional cases in which the identification is very difficult. The stylohyals reported by Lönnberg (1931), Junge (1950) and Omura (1959) show the typical shape in the Bryde's whale and that reported by Andrews (1916) shows that in the sei whale.

On the whole the most important character seems to be the proportional height at the distal end of the combined bone of basihyal and thyrohyals. The genera *Balaenoptera*, *Megaptera* and *Eubalaena* are separated in this character and the proportions in these genera can be expressed as 5-9, 9-12 and 12-19 per cent respectively of the overall length of the combined bone. I have no material from

the grey whale (genus *Eschrichtius*), but according to the report by Andrews (1914) the combined bone of this species resembles very closely to that of *Eubalaena*. It is thought that it cannot be separated from the black right whale in this character. He further reports, however, that in the grey whale the combined bone and stylohyals are rugose bones. He also reports that the stylohyals are decidedly more like to those of the genus *Balaenoptera* than the genus *Eubalaena*. The above two facts may be the distinction between the two genera (or families).

The genus *Balaenoptera* is further divided into two groups by the proportional height at center of the combined bone. The blue (*B. musculus*) and fin (*B. physalus*) whales belong to one group and the rest to the another. The blue and fin whales are then separated decidedly from each other by the proportional height at the middle of the wing of the combined bone.

Among the another group i.e. the sei (*B. borealis*), Bryde's (*B. edeni*) and minke (*B. acutorostrata*) whales, the minke whale is separated from the other two by the total height of the combined bone. The remaining two species are not separated from each other in the combined bone as stated already.

In the stylohyals each species of the genus *Balaenoptera* is separated by the proportional length of stylohyals and then by the proportional height at middle of the bone. Further the blue whale is separated very clearly from the other species by the proportional thickness at middle of the stylohyals.

The above is arranged in the order of the following systematic key.

Key to the genera and species of mystacoceti
by means of hyoid bone

1. Height at distal end of the combined bone of basihyal and thyrohyals more than 12 per cent of its overall length. 2
- The same height 9–12 per cent. Bone surface much corrugated.
Genus *Megaptera*. Single species. *M. novaeangliae*
- The same height less than 9 per cent. Bone surface smooth.
Genus *Balaenoptera*. 3
2. Bone surface much corrugated. Stylohyals massive but not cylindrical.
Genus *Eschrichtius*. Single species. *E. gibbosus*
- Bone surface smooth. Stylohyals roughly cylindrical. Basihyal and thyrohyals separated in younger stages.
Genus *Eubalaena*. Single species *E. glacialis*
3. Height at center of the combined bone less than 18 per cent of its length. . 4
- The same height more than 18 per cent. 5
4. Height at middle of the wing of the combined bone less than 12.5 per cent of the length. Stylohyals long and narrow. *B. physalus*
- The same height more than 12.5 per cent. Stylohyals short, broad and massive. *B. musculus*
5. Greatest height of the combined bone less than 29 per cent of the length. *B. acutorostrata*
- The same height more than 29 per cent. 6

6. Stylohyals broad, flat and much curved forwards *B. borealis*
 —. Stylohyals less broad, rather thick and less curved. *B. edeni*

In the above key the greenland whale (*Balaena mysticetus*) and the pigmy right whale (*Caperea (Neobalaena) marginata*) are not included. These two are very rare species, at least at present. The key was made for the convenience of the identification of the species by means of the hyoid bone, disregarding families. It is clear that taxonomic studies on the specific level and above must be based on more than single morphologic comparison and any single taxonomic criterion is less important. My first intention was that to study whether there present any skeletal difference between the whale populations from the different localities within the same species. As already stated before any such racial difference was not proved. But in the case of the fin whale the population in the Bering Sea show lower value than that in the Antarctic in the proportional height at middle of the wing (Fig. 6) and also in the proportional height at distal ends of the combined bone (Fig. 2). These give the former bone a slender appearance than the latter. The two standard errors calculated for the both are overlapping very slightly. The sample number used for the present study is rather limited and it is thought probable that a significant difference might be proved when more samples are gathered. Also in the sei whale collection of more samples are needed in order to discuss the difference between that from the Antarctic and that from the coast of Japan. It might be most interesting to compare the hyoid bone from the usual blue whale in the Antarctic to that of the pigmy blue whale.

In conclusion more attention than before should be paid on the morphological study of the hyoid bone in establishing relationships of subspecies, species and genera of the baleen whales.

SUMMARY

The hyoid bones of the baleen whales were collected from seven species. These are the blue, fin, sei, Bryde's, minke, humpback and black right whales. For the fin and sei whales they are collected from the two different localities. Total number of whales from which the bones were sampled had amounted a little over 100. Various measurements were made on each bone and then they were treated statistically. Distinctions among species were studied and a key to the genera and species of baleen whales (mystacoceti) by means of hyoid bone was prepared. Distinction between different populations within the same species was not proved statistically, but it is thought more collection is necessary in order to obtain a conclusion on this matter.

ACKNOWLEDGEMENT

Sincere thanks are due to my colleague in the Whales Research Institute. They helped me in the collection and measurement of the samples. Especially I am very grateful for Drs. K. Fujino and T. Nemoto. They also took photographs shown in Plates I–XV.

REFERENCES

- ANDREWS, R.C. (1914). The California gray whale (*Rhachianectes glaucus* Cope). *Mem. Amer. Mus. Nat. Hist., New series*, 1(V): 229–87.
- (1916). The sei whale (*Balaenoptera borealis* Lesson). *Mem. Amer. Mus. Nat. Hist., New series*, 1(IV): 291–388.
- ICHIHARA, T. (1961). Blue whales in the waters around Kerguelen Island. *Norsk Hvalfangst-Tid.*, 50(1): 1–20.
- (1963). Identification of the pigmy blue whale in the Antarctic. *Norsk Hvalfangst-Tid.*, 52(5): 128–30.
- JOHNSON, M.L. & OSTENSON, B.T. (1959). Comments on the nomenclature of some mammals of the Pacific Northwest. *J. Mamm.* 40: 571–7.
- JUNGE, G.C.A. (1950). On a specimen of the rare fin whale, *Balaenoptera edeni* Anderson, stranded on Pulu Sugi near Singapore. *Zoologische Verhandelingen*, no. 9: 1–26.
- LÖNNBERG, E. (1931). The skeleton of *Balaenoptera brydei* O. Olsen. *Arkiv f. Zoologi*, 23(1): 1–23.
- OMURA, H. (1957). Osteological study of the little piked whale from the coast of Japan. *Sci. Rep. Whales Res. Inst.*, no. 12: 1–21.
- (1958). North Pacific right whale. *Sci. Rep. Whales Res. Inst.*, no. 13: 1–52.
- (1959). Bryde's whale from the coast of Japan. *Sci. Rep. Whales Res. Inst.*, no. 14: 1–33.
- SPRAGUE, J.M. (1941). A study of the hyoid apparatus of the Cricetinae. *J. Mamm.* 22: 296–310.

ICR

一般財団法人 日本鯨類研究所
THE INSTITUTE OF CETACEAN RESEARCH

APPENDIX 1. MEASUREMENTS OF HYOID BONE (in cm.)
 See text for explanation of abbreviation and measurements number

Species, locality	Body No. length	Sex	Measurement																				
			a	b	c	d	e	f	g	h	i	j	k	l	m	n	o	p	q	r	s		
BmA	1	2000	M	136.0	113.0	38.0	20.2	13.7	19.8	19.5	12.2	12.1	10.3	9.7	55.5	17.6	9.5	2.2	55.0	18.3	9.3	2.7	
	2	2100	F	150.0	127.0	42.4	22.7	17.0	20.0	19.3	12.2	12.5	11.3	11.9	60.0	18.3	10.9	3.5	61.0	18.4	11.2	4.0	
	3	2100	M	147.0	120.0	44.4	26.2	14.5	22.5	22.7	15.2	14.6	9.3	9.9	55.0	20.2	12.3	3.1	56.0	20.2	12.2	3.0	
	4	2230	M	— ³⁾	—	43.5	26.5	14.0	22.2	23.2	14.3	14.6	—	—	65.0	19.8	12.1	3.5	—	—	—	—	
	5	2280	F	146.0	120.0	43.8	25.5	15.4	22.6	21.8	16.4	16.9	11.2	11.4	57.0	20.5	12.2	3.5	59.5	20.7	12.1	4.0	
	6	2280	M	115.0	129.0	45.3	28.0	14.0	25.8	26.0	16.5	16.8	11.8	11.0	63.0	21.2	12.3	1.4	62.5	21.5	12.5	1.4	
	7	2300	F	168.0 ⁴⁾	—	44.6	25.6	13.4	22.0	22.6	15.8	15.3	—	10.1	62.0	21.4	9.6	4.0	62.0	21.8	10.1	4.1	
	8	2050	F	144.0	112.0	44.6	24.8	17.0	19.2	18.5	12.5	12.5	12.0	13.0	56.5	19.0	9.0	7.0	58.0	19.9	9.0	7.0	
	9	2250	F	158.0	133.0	46.3	24.3	20.0	21.2	21.4	13.4	13.4	13.1	10.3	61.0	20.6	11.3	8.0	60.5	20.4	11.0	8.9	
BpA	1	1940	F	104.0	88.0	—	16.0	—	12.6	12.4	10.4	10.0	7.2	7.4	47.0	12.5	6.7	1.3	48.0	12.5	6.4	1.3	
	2	1950	M	119.0	99.0	29.8	18.8	10.5	12.7	12.7	10.6	10.2	7.4	7.4	54.0	11.4	7.1	1.1	54.0	11.3	7.0	1.3	
	3	2040	M	130.0	109.0	38.8+	23.0	7.8+	14.3	14.7	12.3	13.0	10.0	10.9	55.0	19.2	6.3	4.2	55.5	19.0	6.4	4.0	
	4	2090	M	124.0	108.0	34.8	22.5	9.5	13.3	13.4	9.9	9.9	8.2	7.8	55.0	14.7	5.3	6.5	55.0	14.5	5.7	7.5	
	5	2110	F	119.0	104.0	—	17.3	—	15.2	14.8	12.6	13.0	8.0	7.8	55.0	12.8	7.6	4.0	54.0	13.4	7.6	3.9	
	6	2110	M	133.0	109.0	33.1	19.4	11.2	12.9	13.4	11.3	11.5	8.8	8.7	64.0	17.3	5.8	4.5	63.0	17.4	5.6	4.2	
	7	2130	M	128.0	109.0	33.6	19.1	11.0	14.9	14.7	10.0	9.7	9.0	8.5	56.0	11.8	6.2	—	57.5	12.5	5.6	5.7	
	8	2170	F	124.0 ⁴⁾	—	—	17.6	—	15.6	15.4	13.0	12.7	9.4	9.2	59.0	16.2	8.0	5.8	59.0	16.0	8.0	6.0	
	9	2190	F	123.0	109.0	35.3	17.2	13.5	11.5	11.7	9.6	9.9	8.7	9.2	57.0	15.0	5.0	5.8	57.0	14.9	5.4	5.7	
	10	2270	F	125.0	109.0	33.5	17.4	15.5	14.3	13.8	10.8	10.6	8.4	8.3	59.0	13.3	5.6	6.6	60.0	13.5	5.8	6.5	
	BpB	11	720	M	108.0	91.0	33.0	17.3	11.4	9.7	10.1	7.9	7.5	5.9	5.9	50.0	12.0	4.5	5.3	50.0	12.3	4.8	5.4
		2	1790	M	118.0	97.0	26.3	16.3	9.0	11.5	12.2	10.4	10.0	7.9	8.1	56.0	13.0	5.2	5.0	56.0	13.0	5.2	5.0
3		1850	M	106.0	90.0	25.3	17.3	7.2	10.6	10.5	8.8	8.6	6.1	6.2	47.0	12.3	4.4	3.6	48.0	12.1	4.5	4.1	
4		1870	M	109.0	91.0	27.0+	16.7	8.2+	10.5	10.5	9.0	8.9	6.5	6.5	48.0	8.4	4.8	4.6	48.0	8.4	4.8	4.7	
5		1890	F	120.0	101.0	42.0	25.5	15.3	14.1	14.3	11.5	11.3	6.9	7.2	54.0	11.1	6.4	4.3	54.0	12.0	6.7	4.3	
6		2010	M	118.0	100.0	29.0+	15.5	10.6+	12.0	11.1	9.0	8.4	7.9	7.9	53.5	13.0	5.2	4.2	53.0	13.5	5.3	4.0	
7		2020	F	124.0	106.0	38.0	18.3	13.5	14.0	13.3	11.1	11.3	6.2	7.1	57.0	15.2	6.3	7.2	56.0	14.7	6.2	7.0	
8		2180	F	135.0	110.0	32.3	17.0	10.5	12.3	13.0	12.2	12.2	7.6	8.3	60.0	15.5	6.7	6.7	60.0	14.5	7.1	5.8	
9		— ²⁾	123.0	99.0	37.3	23.2	12.4	14.2	14.3	14.3	9.7	9.6	8.4	8.2	56.0	15.7	5.2	3.4	56.0	15.3	5.5	4.8	
10		— ²⁾	111.0	97.0	25.6	17.7	6.0	10.9	10.8	9.8	9.4	9.4	8.0	8.0	53.5	12.1	5.6	4.0	54.0	12.1	5.6	4.0	
11	— ²⁾	116.0	92.0	25.2	16.2	7.5	10.0	10.3	10.0	9.7	9.7	7.2	7.0	50.0	10.6	4.6	5.5	50.0	11.0	4.5	5.1		

		a	b	c	d	e	f	g	h	i	j	k	l	m	n	o	p	q	r	s		
BpB	12	— ²⁾	106.0	92.0	26.8	15.2	9.8	10.9	10.6	8.8	9.1	7.4	7.4	51.0	10.2	4.6	3.1	52.0	10.1	4.8	3.0	
	13	— ²⁾	109.0	97.0	26.9	17.1	8.8	11.1	10.9	8.9	8.8	6.8	6.6	46.0	9.9	4.7	4.3	47.5	10.0	4.6	4.2	
BbA	1	1300	F	91.0	79.0	25.6+	18.0	6.3+	12.5	11.8	6.3	6.7	6.7	45.0	14.2	4.3	5.7	45.0	14.1	4.5	5.3	
	2	1450	F	85.0	76.0	30.2	19.2	10.5	10.9	10.3	5.0	5.1	5.8	6.0	46.0	16.5	5.0	3.5	47.0	16.8	5.0	4.0
	3	1450	F	88.0	72.0	26.8	15.0	10.7	10.0	10.4	4.5	4.6	6.5	6.1	42.0	15.3	4.7	5.3	42.0	15.7	4.8	5.1
	4	1520	F	87.0	78.0	33.0	21.9	10.5	14.1	13.7	5.4	5.2	6.3	6.0	48.0	16.4	4.8	5.4	48.0	16.2	4.6	5.2
	5	1560	F	83.0	79.0	25.9	15.1	10.8	10.9	10.9	6.1	6.3	6.8	6.4	46.0	14.2	5.0	5.3	48.0	14.3	4.9	5.2
	6	1570	F	92.0	79.0	27.0	19.5	8.0	9.8	10.3	5.6	6.3	6.4	45.0	16.2	4.2	4.0	45.0	16.9	4.7	3.8	
	7	1610	F	99.0	84.0	33.3	18.8	13.0	11.0	11.1	6.1	5.9	6.3	6.9	50.0	20.1	6.7	3.9	49.0	19.9	6.8	4.0
	8	1610	F	96.0	79.0	28.1	18.9	8.7	11.9	12.3	5.8	6.4	6.0	6.6	45.0	18.0	5.4	8.0	—	—	—	—
	9	1670	F	100.0	82.0	33.0	20.5	12.5	11.3	11.1	5.6	5.6	6.8	6.2	47.0	14.2	4.8	8.8	46.0	14.8	4.8	8.6
BbC	1	1280	F	66.0	61.0	22.7	15.2	7.0	8.0	8.3	4.6	4.5	4.7	4.6	39.0	12.0	4.3	4.8	40.0	12.0	4.5	4.5
	2	1280	F	69.0	61.0	22.2	10.9	9.4	9.4	9.3	4.4	4.2	3.8	3.6	37.0	11.8	4.0	5.8	37.0	11.9	3.9	5.9
	3	1290	M	75.0	66.0	23.0	12.2	9.2	9.2	9.1	5.2	5.1	5.1	5.3	40.0	13.0	4.5	3.9	40.0	13.3	4.3	3.9
	4	1300	M	74.0	66.0	23.9	16.6	6.3	10.0	9.9	5.5	5.5	5.0	4.8	37.0	12.5	4.7	4.1	38.0	12.6	4.9	3.5
	5	1340	M	75.0	64.0	21.5	14.0	6.4	7.5	8.1	5.4	5.3	5.8	5.6	39.0	12.9	4.0	5.8	40.0	13.5	4.0	5.7
	6	1350	F	81.0	70.0	26.2	17.0	8.2	10.1	10.5	6.0	5.9	5.4	5.0	40.0	13.2	4.1	3.6	40.0	14.1	4.4	4.5
	7	1360	M	76.0	64.0	26.8	16.2	9.6	10.4	10.5	4.8	4.7	3.8	4.0	41.0	12.8	3.6	5.7	42.0	12.8	3.6	5.3
	8	1370	M	77.0	67.0	24.4	14.8	8.0	8.3	8.8	4.8	4.8	4.9	5.1	38.0+	13.6	3.5	3.4	44.0	13.2	3.5	5.5
	9	— ²⁾	81.0	70.0	24.6	15.7	7.6	8.9	9.1	4.6	4.8	4.3	4.5	41.0	14.4	5.1	4.4	42.0	14.6	5.0	4.3	
	10	— ²⁾	90.0	75.0	22.5	17.5	4.3	11.0	11.1	6.5	6.4	4.9	4.9	44.0	16.1	5.0	7.7	46.0	16.1	5.1	8.0	
BeC	1	1230	M	78.0	67.0	—	13.6	—	9.6	10.1	6.0	5.8	5.2	5.3	38.5	12.3	5.3	2.5	39.0	11.9	5.2	2.1
	2	1290	F	78.0	70.0	25.5	14.6	10.6	8.3	8.4	6.0	6.1	5.5	5.1	41.0	11.8	5.1	1.6	40.0	11.5	5.2	1.4
	3	1200	M	72.0	64.0	22.5	13.7	8.7	8.6	8.6	5.2	4.9	5.7	5.8	—	—	—	—	—	—	—	—
	4	1230	F	75.0	64.0	23.2	12.6	9.3	8.6	8.7	5.5	5.5	5.6	5.5	—	—	—	—	—	—	—	—
	5	1260	F	73.0	67.0	23.1	15.2	7.0	9.0	9.5	4.8	4.7	4.7	4.9	—	—	—	—	—	—	—	—
	6	1270	M	72.0	62.0	25.2	16.0	9.3	9.9	10.2	5.8	5.8	6.4	6.0	—	—	—	—	—	—	—	—
	7	1270	M	75.0	64.0	27.1	15.7	9.7	10.6	10.4	4.3	4.2	5.5	5.5	—	—	—	—	—	—	—	—
	8	1360	F	85.0	73.0	24.3	13.9	10.0	9.2	9.5	6.5	6.7	6.1	6.0	—	—	—	—	—	—	—	—
	9	1360	F	89.0	78.0	—	17.3	—	10.3	10.1	6.6	6.8	6.2	6.0	—	—	—	—	—	—	—	—
	10	1230	M	75.0	64.5	24.2	15.6	8.2	8.8	9.2	5.5	5.3	4.8	5.1	39.6	11.4	5.1	2.9	40.0	11.8	5.1	2.7
	11	1250	M	74.5	66.7	25.3	15.1	9.1	9.3	9.5	5.1	5.1	5.5	5.2	41.4	11.7	6.0	2.1	41.3	11.6	6.3	2.1
	12	1270	M	79.3	70.5	24.0	13.5	10.5	8.6	9.0	6.0	5.9	4.8	5.5	42.8	11.0	5.1	3.6	43.2	10.6	5.0	3.8
	13	1290	F	77.4 ⁴⁾	—	25.1	15.9	9.1	9.8	—	6.3	—	5.8	—	42.1	11.2	6.2	4.0	41.7	11.0	5.9	3.8

HYOID BONES

		a	b	c	d	e	f	g	h	i	j	k	l	m	n	o	p	q	r	s			
BeC	14	1300	M	83.0	70.7	25.6	14.8	10.7	9.6	9.6	5.6	5.7	5.4	5.5	45.0	12.8	5.6	3.1	45.0	12.9	5.8	2.8	
	15	1310	F	82.6 ⁴⁾	—	25.8	14.3	10.3	8.8	—	5.5	—	4.0	—	39.6	11.3	5.7	3.4	41.0	11.8	6.0	2.9	
	16	1330	F	80.4 ⁴⁾	—	25.2	16.8	7.6	—	8.4	—	6.0	4.4	5.0	40.5	12.3	5.9	3.9	42.0	12.1	5.6	3.2	
	17	1330	F	85.2 ⁴⁾	—	27.8	17.6	8.9	9.7	9.8	6.2	6.0	—	5.6	42.5	13.9	5.9	3.7	43.1	13.9	6.2	4.1	
	18	1340	F	79.2	69.3	24.6	14.5	9.2	9.6	9.4	5.6	5.9	5.5	5.8	40.7	13.2	5.8	3.1	40.7	13.4	5.8	3.5	
	19	1370	F	76.4	69.8	25.2	14.6	9.8	9.6	9.6	5.9	6.1	6.2	6.8	43.4	13.0	5.8	2.9	43.2	12.6	5.8	3.1	
	20	1380	F	80.0	73.7	27.5	17.4	10.1	10.5	9.9	5.7	5.9	5.4	5.5	39.4	12.8	5.7	3.9	40.6	12.7	5.7	4.0	
	21	1390	F	87.0 ⁴⁾	—	28.3	17.5	10.3	—	9.1	—	5.6	—	5.3	43.4	12.0	5.3	5.8	42.6	12.2	5.2	5.3	
	22	1440	F	84.4 ⁴⁾	—	28.4	18.2	10.2	11.1	11.0	5.5	5.6	6.5	6.0	45.9	12.5	5.0	2.5	45.9	12.8	4.9	2.6	
	BaC	1	500	F	34.0	29.2	9.9	7.6	2.5	4.6	4.4	2.6	2.7	2.7	18.2	3.5	1.8	1.8	18.6	3.5	2.0	1.6	
		2	540	F	34.0	30.0	7.9	6.8	1.2	4.6	4.6	2.8	2.6	2.7	15.4	3.6	2.2	0.6	15.7	3.7	2.2	0.6	
		3	576	M	31.9	28.9	9.1	6.8	2.6	4.5	4.5	2.4	2.9	3.0	19.4	3.1	1.8	2.3	19.2	3.2	1.8	2.3	
		4	578	F	32.9	28.6	8.1	6.5	1.3	5.0	5.0	2.4	2.3	2.6	17.9	3.3	2.0	1.6	17.9	3.4	1.9	1.7	
		5	580	M	33.8	31.2	9.3	7.2	2.1	4.6	5.0	2.4	2.5	2.7	19.3	4.1	1.8	1.5	20.1	3.7	1.9	1.5	
		6	580	M	34.8	30.8	8.3	6.8	1.5	4.5	4.5	2.1	2.0	2.3	19.4	3.2	2.0	1.9	19.5	3.3	2.1	1.8	
		7	637	M	37.2	33.5	10.5	7.5	3.0	5.5	5.3	2.5	2.9	2.8	19.4	4.4	2.4	1.6	19.3	4.3	2.5	1.5	
		8	670	M	41.5	37.5	11.9	9.2	2.7	5.8	5.7	2.5	2.6	3.0	20.3	3.7	1.9	1.4	21.3	3.6	2.0	1.3	
		9	710	F	43.2	40.7	12.4	9.6	2.9	6.2	5.8	3.0	3.1	3.3	24.6	4.5	2.5	2.2	24.5	4.3	2.5	1.9	
		10	718	M	42.2	38.2	11.6	10.2	1.2	5.9	5.8	2.7	2.8	3.0	21.3	4.9	2.6	2.2	21.6	4.9	2.6	2.2	
		11	768	M	48.8	42.0	13.5	8.7	4.7	6.5	6.3	2.9	3.0	3.9	4.1	26.3	5.4	2.9	2.4	26.1	5.3	2.9	2.4
	MnB ¹⁾	1	1410	F	83.8	80.0	20.9	15.5	3.1	8.5	8.2	6.6	6.5	7.8	7.5	36.7	5.8	3.7	3.8	37.3	5.5	3.8	3.9
		2	1290	M	81.5	76.8	22.7	16.4	3.4	7.9	7.9	6.4	6.1	7.7	7.6	38.6	5.4	4.0	4.7	37.2	5.4	4.3	4.3
		3	1290	M	73.0	69.5	20.6	16.3	1.8	8.4	8.6	6.2	6.1	7.2	7.1	28.2	5.2	4.0	1.8	29.6	5.1	4.4	1.5
		4	1410	F	89.5	81.3	27.2	20.3	4.5	9.9	10.7	7.7	7.7	8.2	8.2	43.5	6.4	4.3	3.1	43.0	6.7	4.3	3.0
5		1070	M	—	—	—	—	—	—	—	—	—	—	—	—	—	—	—	33.0	5.8	3.5	3.3	
6		1070	F	48.0	42.0	10.7	8.6	1.3	5.2	5.4	4.2	4.2	5.6	5.5	—	—	—	—	—	—	—	—	
7		1130	F	79.0	74.0	—	13.9	—	7.8	8.3	6.1	6.1	7.1	7.1	34.0	6.8	4.0	3.1	—	—	—	—	
8		1130	M	—	—	—	—	—	—	—	—	—	—	—	—	—	—	—	—	—	—	—	
9		1190	M	81.0	62.0	19.2	13.3	3.8	7.0	7.1	5.2	5.5	7.8	7.9	26.0	7.4	3.0	—	26.0	7.6	2.9	—	
10		1250	M	72.0	62.0	19.7	16.8	3.9	8.1	8.2	6.3	6.4	6.4	6.5	—	—	—	—	—	—	—	—	
11		— ²⁾	— ²⁾	—	—	—	—	—	—	—	—	—	—	—	—	—	—	—	—	—	—	—	
12		— ²⁾	— ²⁾	55.0	50.0	14.4	11.6	2.4	7.0	6.9	5.3	5.3	7.0	6.8	—	—	—	—	—	—	—	—	
13		— ²⁾	— ²⁾	79.0	70.0	22.4	16.5	3.3	8.0	7.8	6.0	5.5	7.8	7.8	40.0	6.5	3.8	4.2	—	—	—	—	

	a	b	c	d	e	f	g	h	i	j	k	l	m	n	o	p	q	r	s		
EgB																					
1	1410	F	80.5	74.6	19.2	13.3	1.7	10.0	10.2	7.9	7.8	15.4	14.2	35.3	7.0	5.8	4.2	35.7	6.8	5.3	4.2
2	1470	M	79.0 ¹⁾	—	16.2	12.9	3.1	9.3	9.6	7.0	6.9	11.7	11.4	40.2	5.6	4.5	2.8	38.8	6.1	3.9	2.9
3	1610	M	93.0	90.0	23.2	15.8	3.4	11.9	11.5	8.0	8.0	11.5	11.3	41.7	7.8	3.3	4.1	40.0	7.5	3.0	4.5
4	1610	F	81.0	80.0	20.0	14.2	4.3	11.2	11.1	7.6	6.9	12.2	12.3	34.0	7.1	5.2	3.0	—	—	—	—
5	1540	F	77.0	74.0	18.0	14.2	2.6	9.9	10.4	7.5	7.3	10.5	11.1	—	—	—	—	—	—	—	—

1) 1-4 from Bering Sea, 5-10 from Okinawa.

2) Body length and sex unknown. Identification tag was lost during transportation.

3) Each tip of wings cut off slightly.

4) Double of right or left half. One wing broken.



一般財団法人 日本鯨類研究所
THE INSTITUTE OF CETACEAN RESEARCH

EXPLANATION OF PLATES

The photographs shown in the Plates were all taken from the ventral side. Details of the measurements are shown in Appendix 1.

- Plate I. The combined bone of basihyal and thyrohyals of the blue whale (pigmy) from the Antarctic (BmA). Figs. 1-9 are the order of BmA 1-9.
- Plate II. The combined bone of basihyal and thyrohyals of the fin whale from the Antarctic (BpA). Figs. 1-7 are the order of BpA 1-7, Fig. 8 BpA 9 and Fig. 9 BpA 10.
- Plate III. Upper. The stylohyals of the blue whale (pigmy) from the Antarctic (BmA). Figs. 1-9 are the order of BmA 1-9.
- Plate III. Lower. The stylohyals of the fin whale from the Antarctic (BpA). Figs. 1-10 are the order of BpA 1-10.
- Plate IV. The combined bone of basihyal and thyrohyals of the fin whale from the Bering Sea (BpB). Figs. 1-13 are the order of BpB 1-13.
- Plate V. The stylohyals of the fin whale from the Bering Sea (BpB). Figs. 1-13 are the order of BpB 1-13.
- Plate VI. The combined bone of basihyal and thyrohyals of the sei whale from the Antarctic (BbA). Figs. 1-9 are the order of BbA 1-9.
- Plate VII. The stylohyals of the sei whale from the Antarctic (BbA). Figs. 1-7 are the order of BbA 1-7 and Fig. 8 BbA 9.
- Plate VIII. The combined bone of basihyal and thyrohyals of the sei whale from the coast of Japan (BbC). Figs. 1-10 are the order of BbC 1-10.
- Plate IX. The stylohyals of the sei whale from the coast of Japan (BbC). Figs. 1-10 are the order of BbC 1-10.
- Plate X. The combined bone of basihyal and thyrohyals of the Bryde's whale from the coast of Japan (BeC). Figs. 1-12 are the order of BeC 1-12.
- Plate XI. The combined bone of basihyal and thyrohyals of the Bryde's whale from the coast of Japan (BeC). Figs. 1-10 are the order of BeC 13-22.
- Plate XII. The stylohyals of the Bryde's whale from the coast of Japan (BeC). Fig. 1 BeC 1, Fig. 2 BeC 2 and Figs. 3-15 are the order of BeC 10-22.
- Plate XIII. The combined bone of basihyal and thyrohyals (Figs. 1-11) and stylohyals (Figs. 12-22) of the minke whale from the coast of Japan (BaC). Figs. 1-11 and Figs. 12-22 are the order of BaC 1-11 respectively.
- Plate XIV. Upper. The combined bone of basihyal and thyrohyals of the humpback whale from the Bering Sea and on the coast of Okinawa (MnB). Figs. 1-4 are the order of MnB 1-4, Fig. 5 MnB 6, Fig. 6 MnB 7, Fig. 7 MnB 9, Fig. 8 MnB 10, Fig. 9 MnB 12 and Fig. 10 MnB 13.
- Plate XIV. Lower. Stylohyals of the humpback whale from the Bering Sea (MnB). Figs. 1-4 are the order of MnB 1-4.
- Plate XV. The combined bone of basihyal and thyrohyals (Figs. 1-5) and stylohyals (Figs. 6-9) of the black right whale from the Bering Sea (EgB). Figs. 1-5 are the order of EgB 1-5 and Figs. 6-9 EgB 1-4.

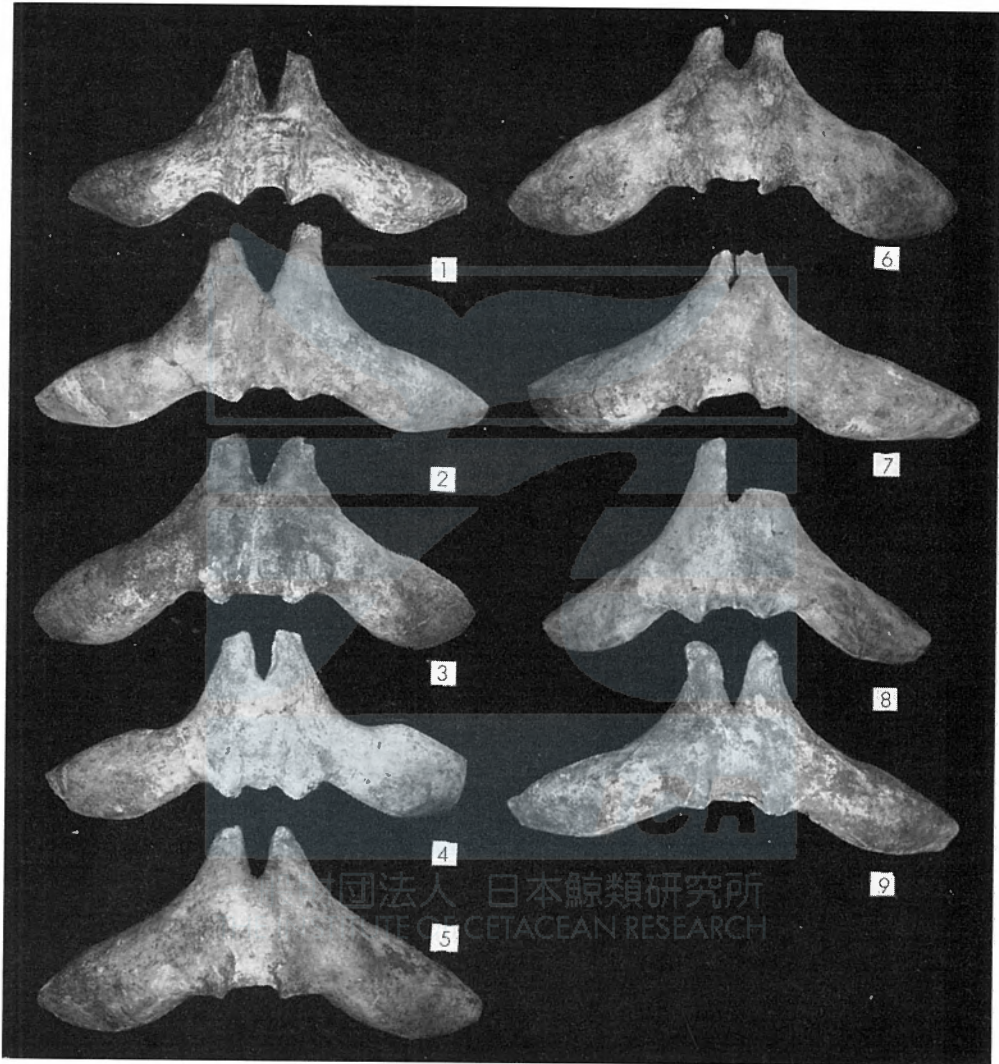

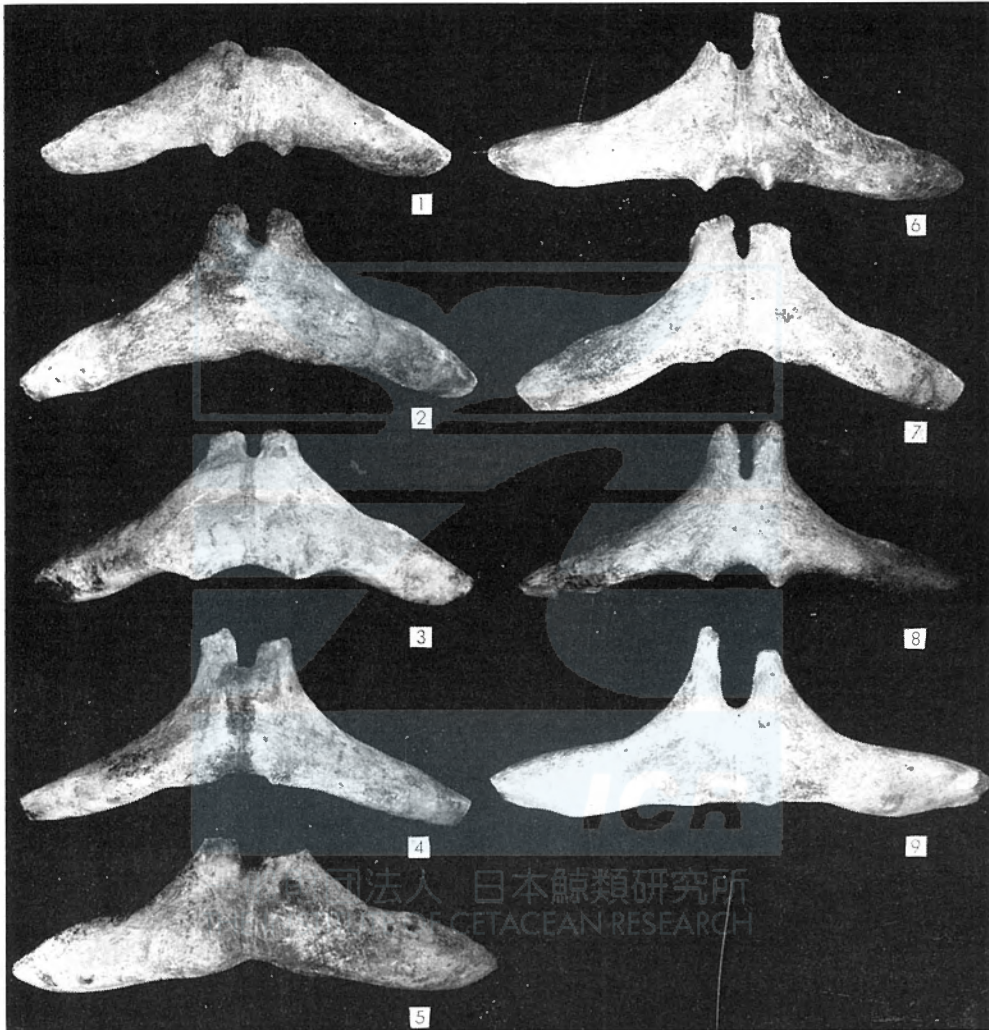

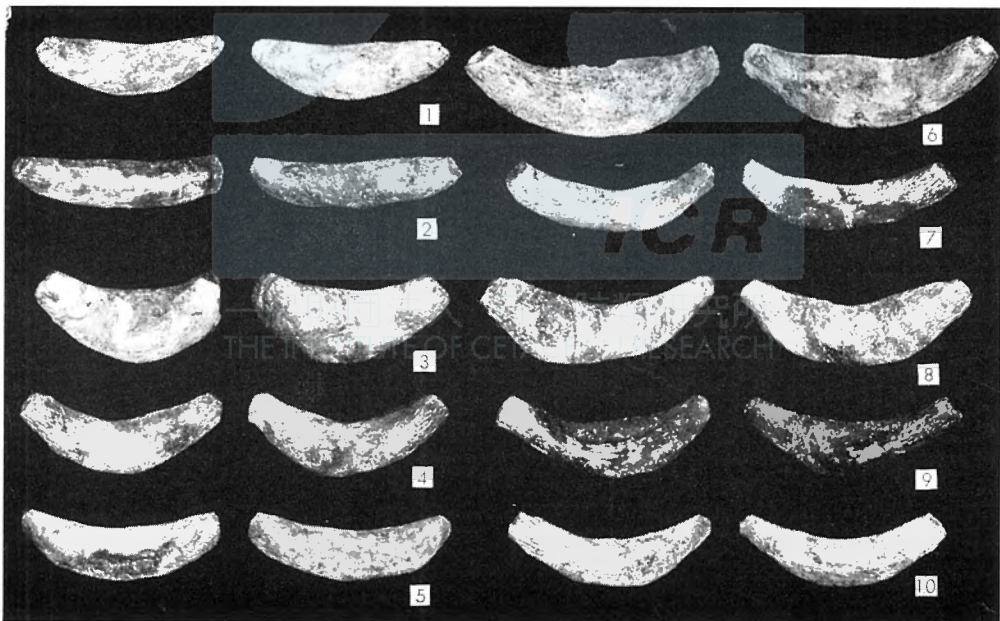
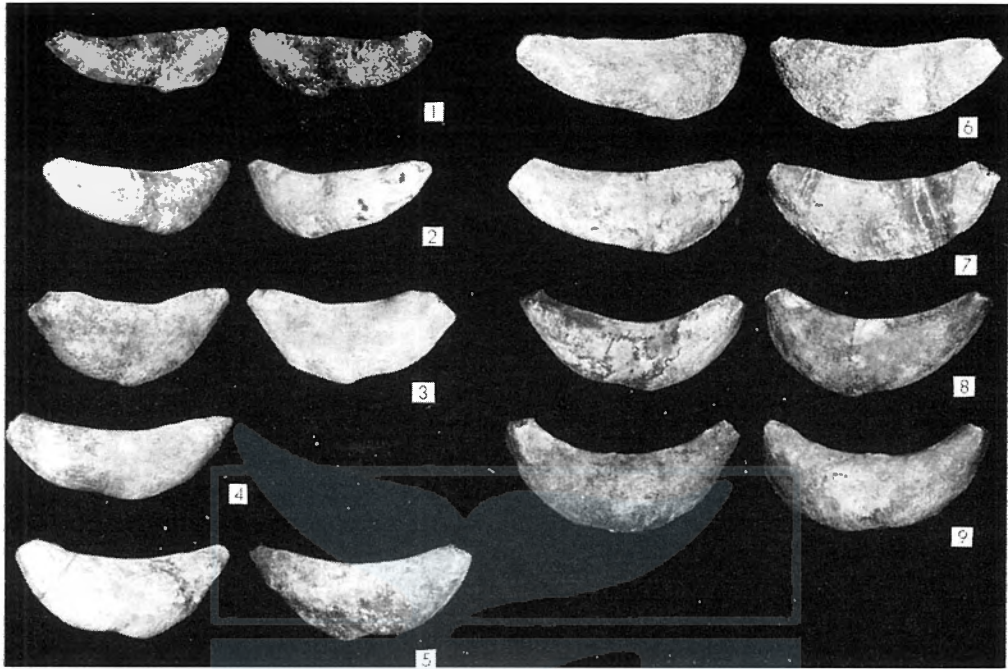

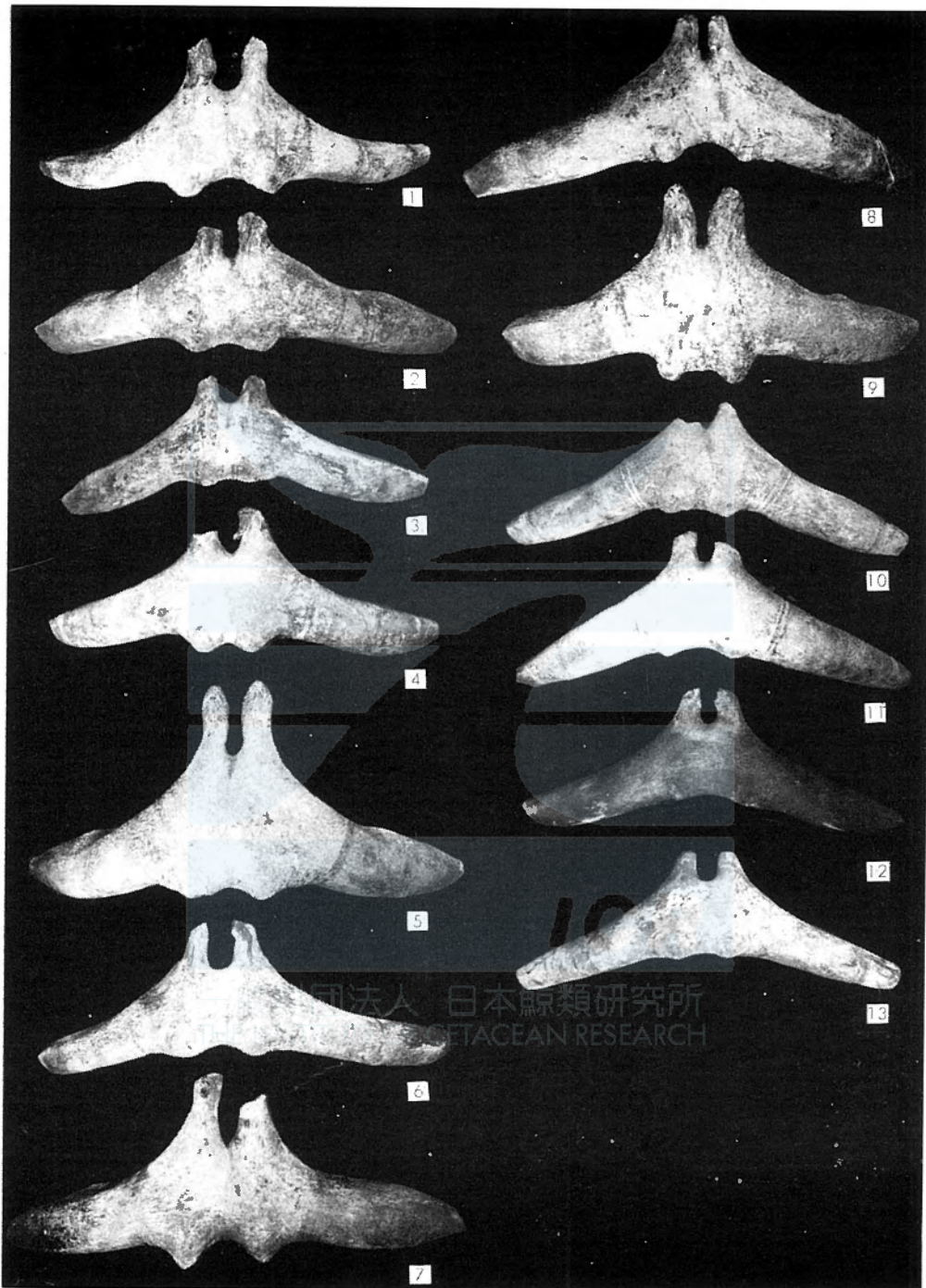

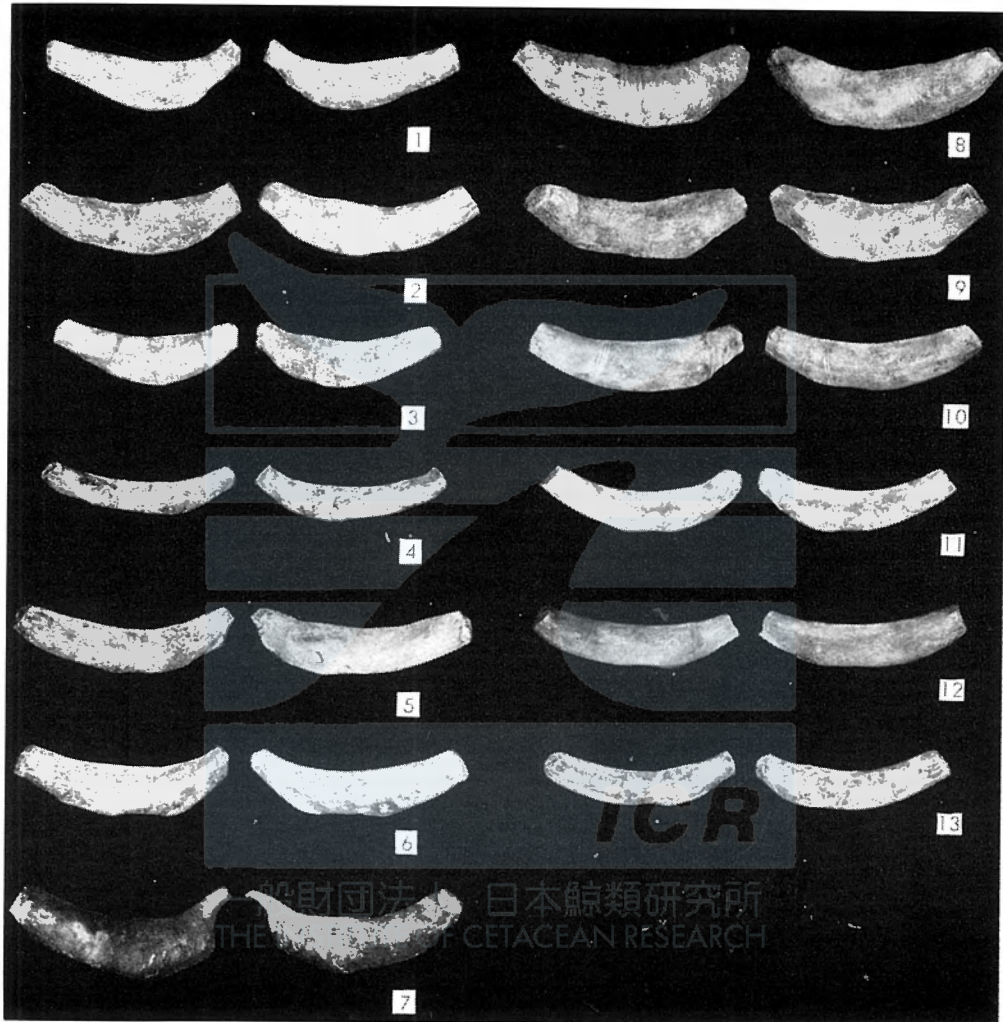

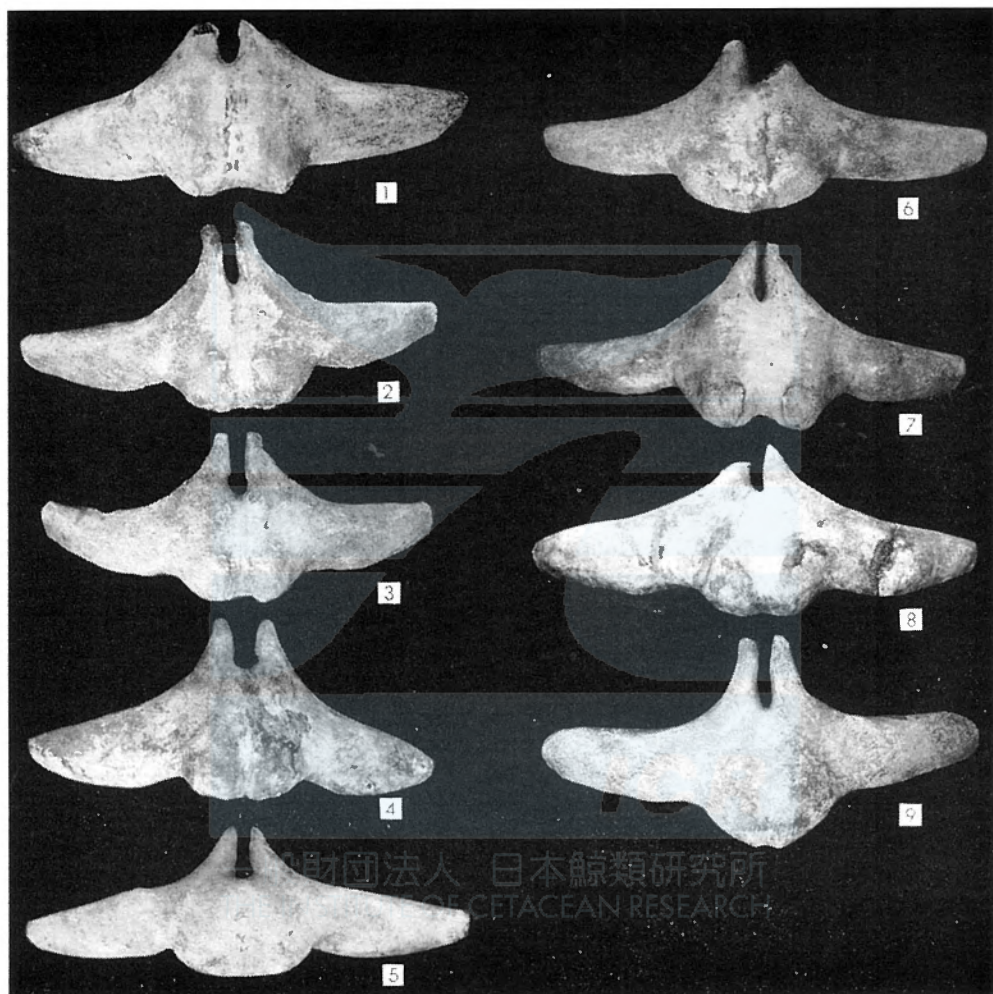

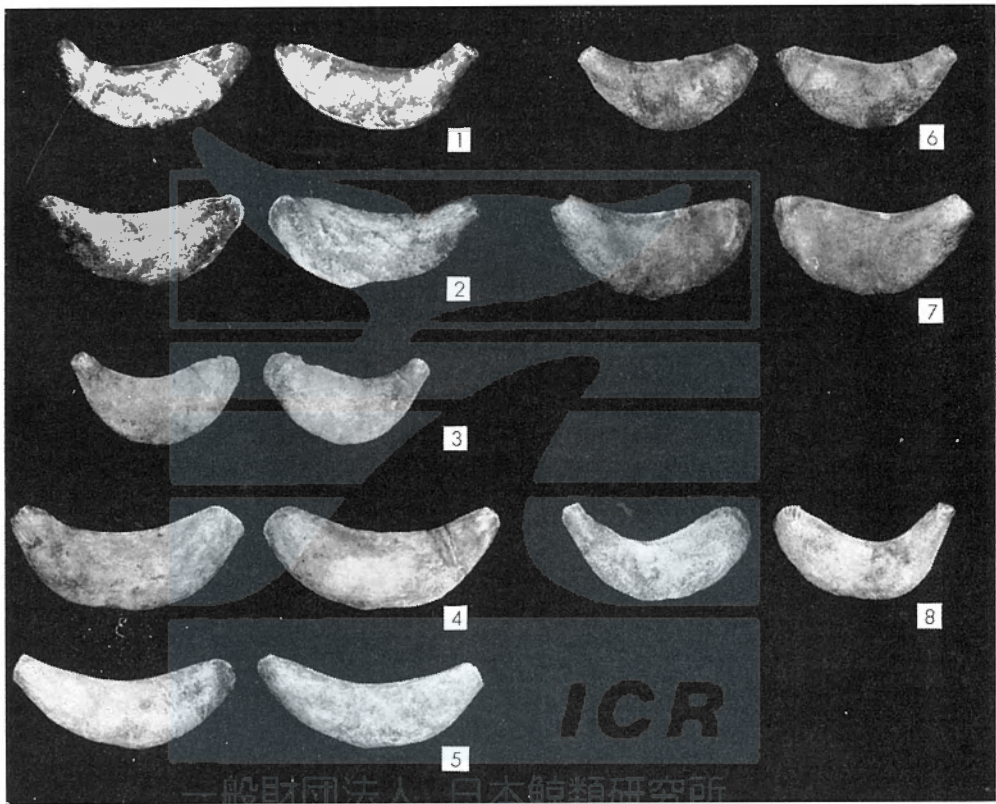

一般財団法人 日本鯨類研究所
THE INSTITUTE OF CETACEAN RESEARCH



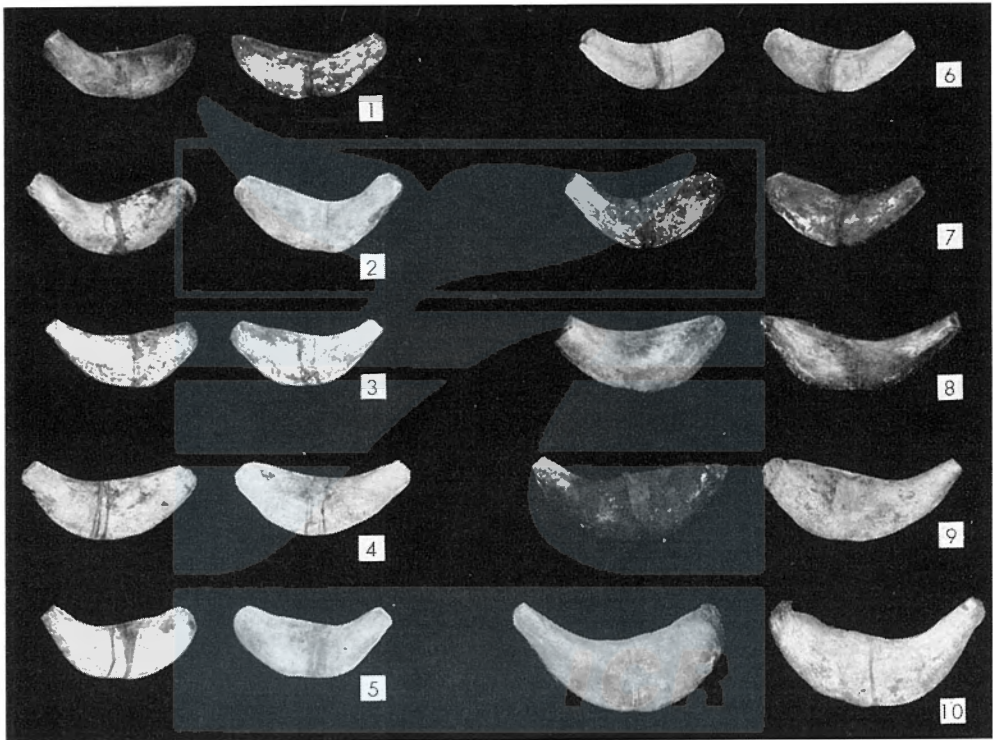

一般財団法人 日本鯨類研究所
THE INSTITUTE OF CETACEAN RESEARCH

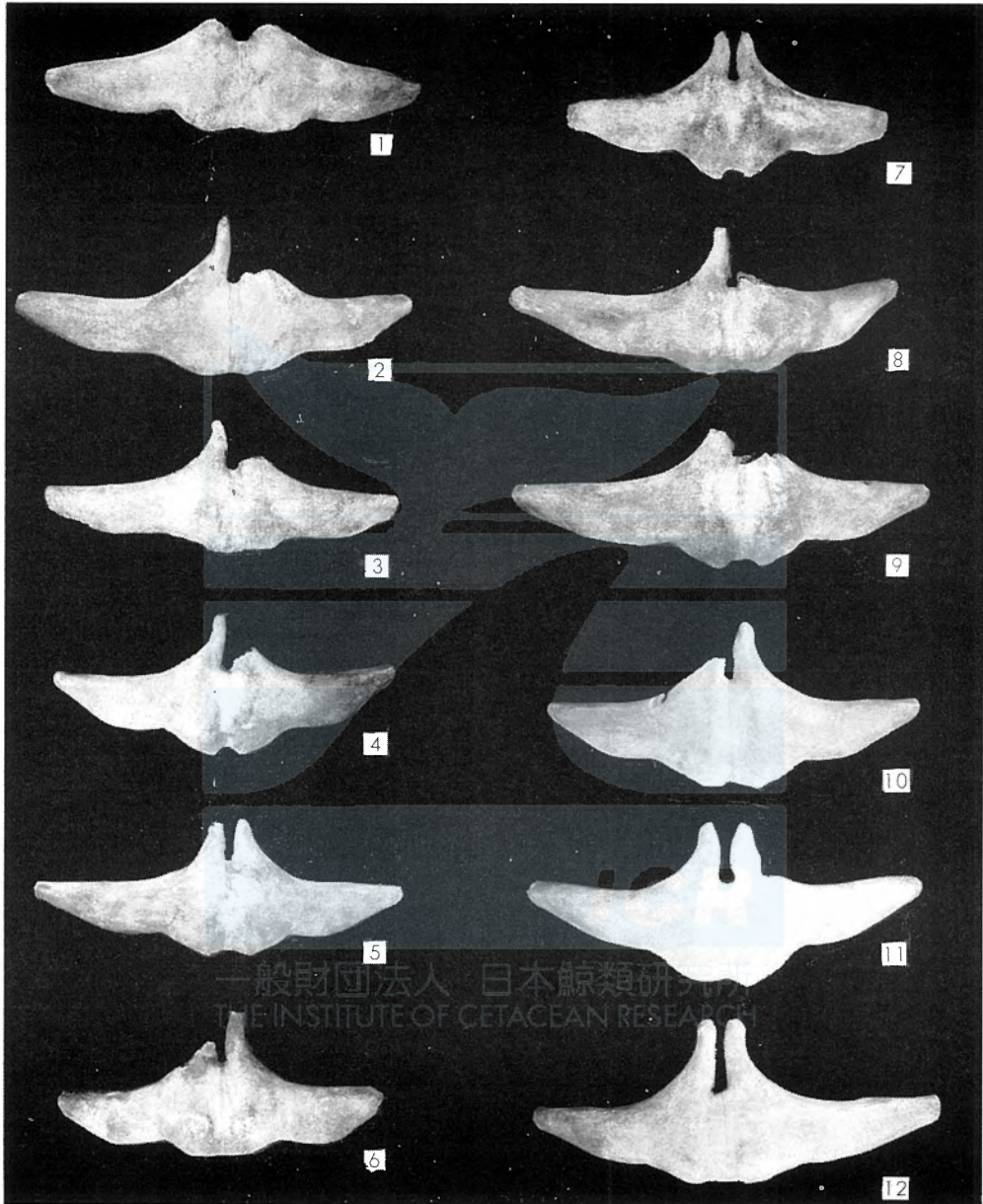

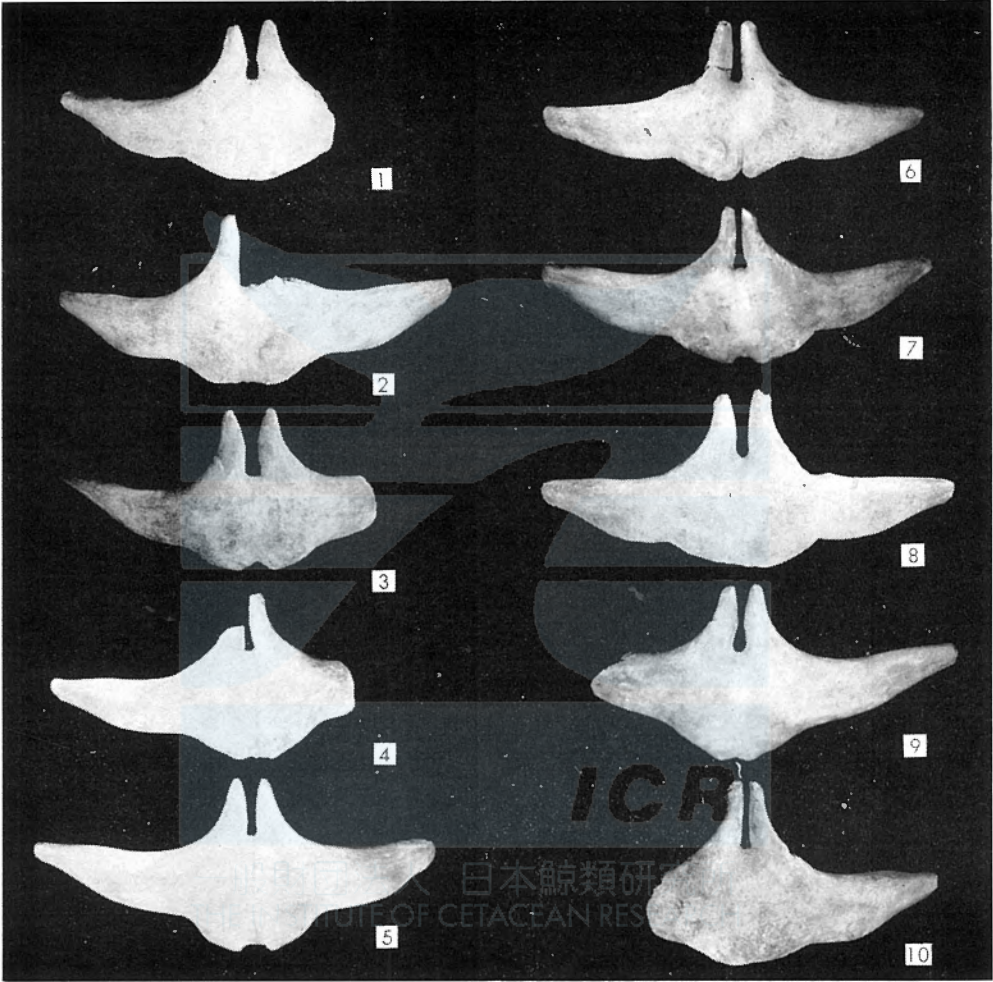

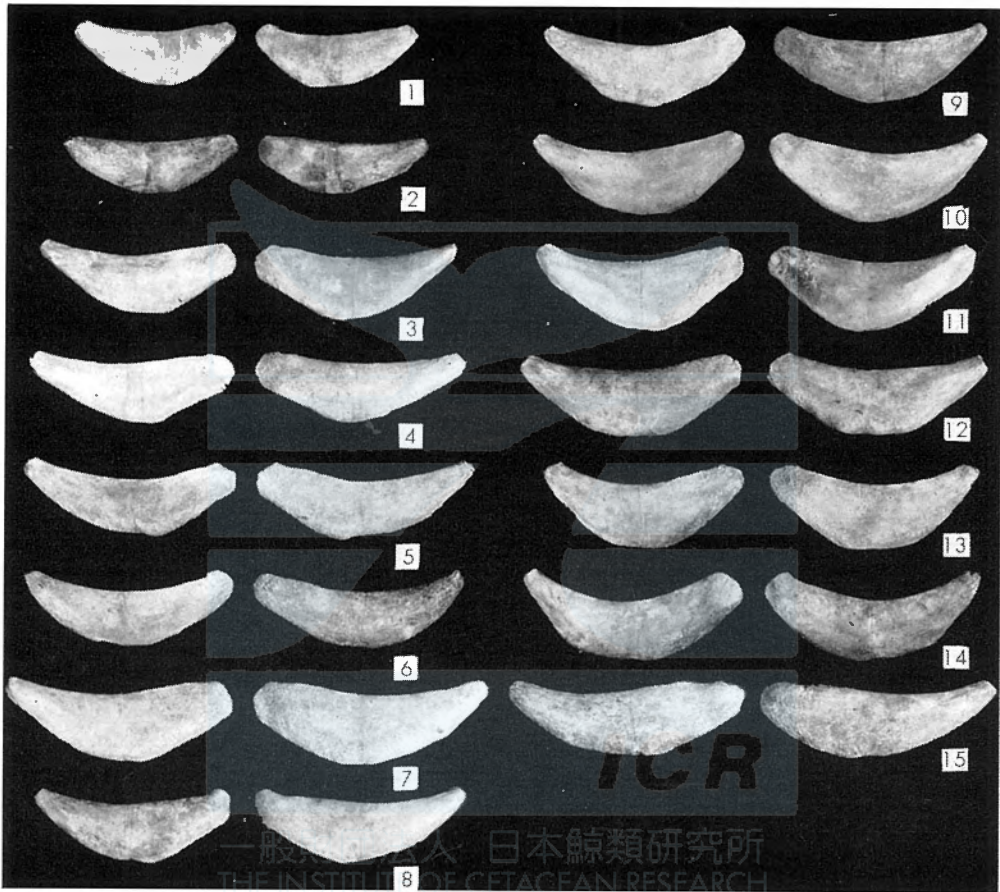

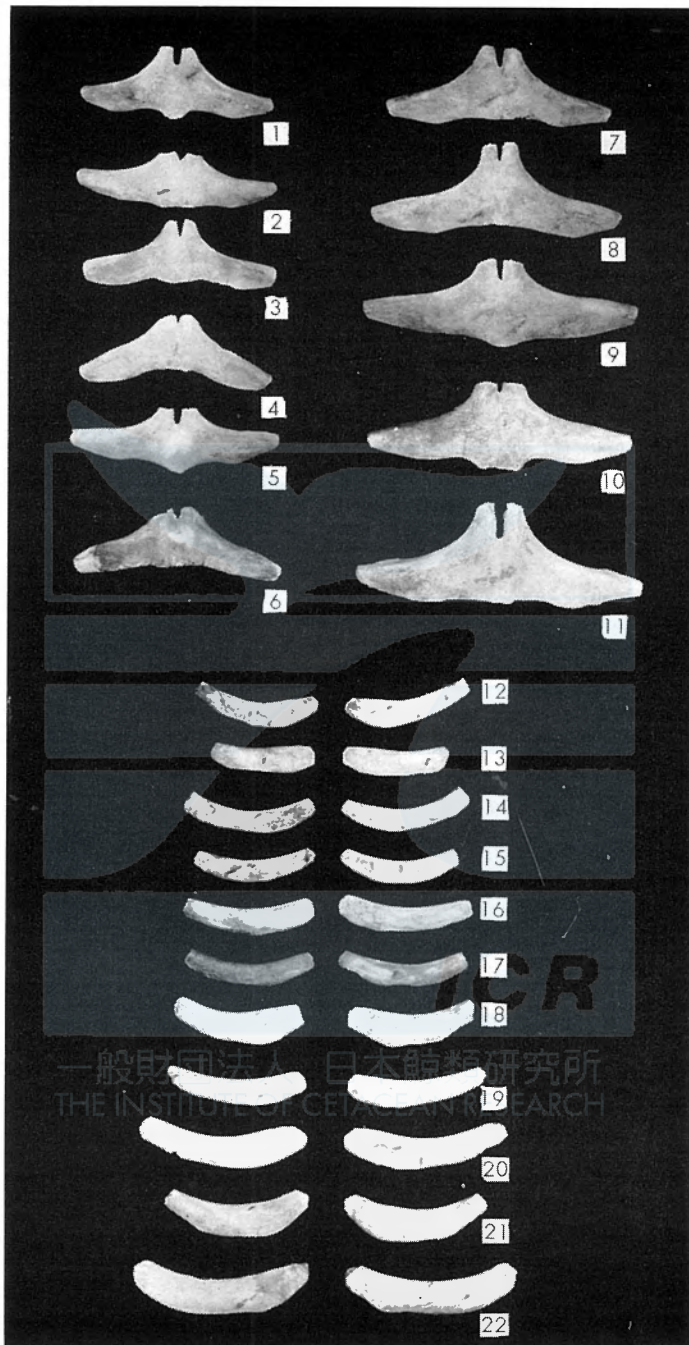

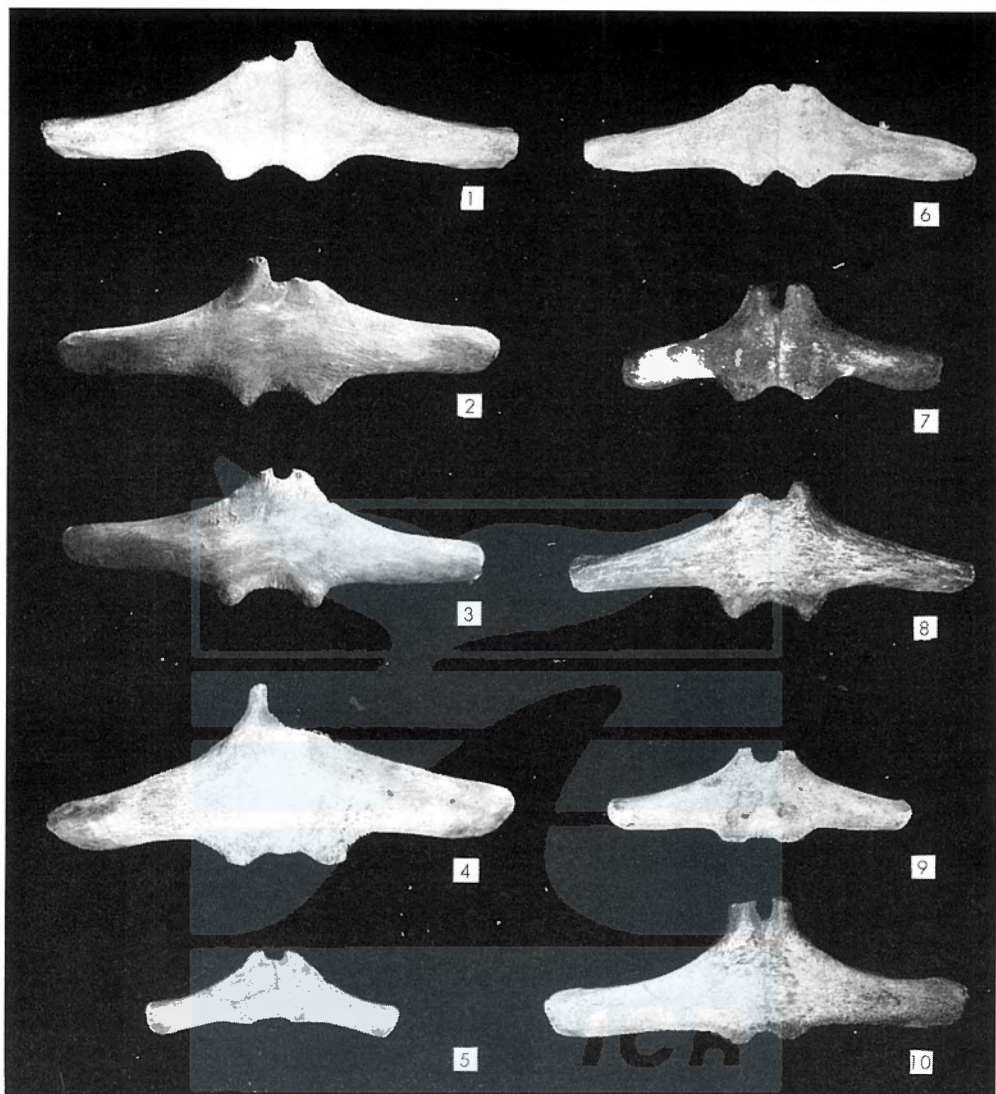



REVISION OF THE ARTICLE “TAXONOMICAL CONSIDERATION ON GENERA OF *DELPHINIDAE*” IN NO. 17

MASAHARU NISHIWAKI

I revealed my opinion on the genera of *Delphinidae* in the Scientific Reports of the Whales Research Institute, No. 17. Some faults and misprints were found in it. Accordingly, I would like to correct them.

Grampus was used as the scientific name of killer whale, but it should be changed to *Orcinus*, and *Grampidelphis* of Risso's dolphin should be changed to *Grampus*. It seems that *Neomeris* will better to be changed to *Neophocaena*.

Fortunately I could study on *Cephalorhynchus* and *Sotalia* recently in United States. According to the observation, *Cephalorhynchus* and *Sotalia* were considered as the *Delphinus* type. The family *Delphinidae*, therefore, is consisted from the eight genera as follows; *Delphinus*, *Stenella*, *Sotalia*, *Cephalorhynchus*, *Lagenorhynchus*, *Tursiops*, *Steno* and *Lissodelphis*.

Globidelphinidae could not use by the code, and the genus *Grampidelphis* was changed to the genus *Grampus* again. I would like to suggest an idea a new family *Grampidae* for the Risso's dolphin (*Grampus griseus*).

13 and 14, attached number of marks in the Fig. 1, should be exchanged each other.

Dentition and length/breath ratio of rostrum and skull on *Globicephala* and *Grampidelphis* in the page 103 of No. 17 should be exchanged their places.

I am considering that the suborders *Mystacoceti* and *Odontoceti* are reasonable enough to be arised in the independent order respectively. However, I shall discuss about this problem in next chance, because this paper is the information of the genera and the families in the *Odontoceti*.

The key to the living families of *Odontoceti* should be changed as follows.

ICR
一般財団法人 日本鯨類研究所
THE INSTITUTE OF CETACEAN RESEARCH

KEY TO THE LIVING FAMILIES OF *ODONTOCETI*

- 1₁ Tip of lower jaw ending an appreciable distance behind foremost part of head ; lower teeth functional, upper teeth rudimental and usually found in gum.
- 2₁ Head massive, 1/4 to 1/3 of body length ; blowhole far forward on head ; functional teeth large, 18 to 28 pairs confined to lower jaw ; dorsal fin an ill-defined lump ; flipper rounded ; size large (30 to 60 feet) ; 1st cervical vertebra (atlas) free, 2nd (axis) to 7th cervical vertebrae fused. *Physeteridae*
- 2₂ Head 1/6 of body length ; functional teeth small, slender and curved, 9 to 16 pairs confined to lower jaw ; dorsal fin well developed ; flippers tapering ; size small (9 to 13 feet) ; all cervical vertebrae fused. *Kogiidae*
- 1₂ Lower jaw extending at least as far as tip of snout ; blowhole some distance from tip of snout.
- 3₁ Two conspicuous grooves forming a V-shape on the surface of throat blubber ; dorsal fin present, considerably behind middle of body ; notch of tailflukes usually shallow or absent ; foremost 3 or 4 cervical vertebrae fused. *Ziphiidae*
- 3₂ No grooving on throat ; dorsal fin when present at or near middle of body ; notch of tailflukes conspicuous.
- 4₁ Seven cervical vertebrae all separate from one another.
- 5₁ Dorsal fin absent or rudimentary ; beak absent ; inhabits Arctic region. *Monodontidae*
- 5₂ Dorsal fin present but almost low ; beak extremely long (1/6 to 1/7 of body length) ; inhabits fresh water in tropical or warmer region ; teeth very numerous in upper and lower jaws. *Platanistidae*
- 4₂ Two or more cervical vertebrae fused.
- 6₁ Beak long and narrow (breadth of snout less than 1/2 of its length) ; more than 20 teeth in each row of upper jaw ; size small (less than 13 feet) ; usually 1st (atlas) and 2nd (axis) cervical vertebrae fused. *Delphinidae*
- 6₂ Head without distinct beak.
- 7₁ Only 1st (atlas) and 2nd (axis) cervical vertebrae fused ; less than 20 teeth in each row of upper jaw ; size small. *Orcellidae*
- 7₂ Not only atlas and axis fused, but also third or more cervical vertebrae fused.
- 8₁ Each row of upper teeth more than 15 ; body length less than 8 feet. *Phocaenidae*
- 8₂ Each row of upper teeth less than 15 ; body length more than 8 feet.
- 9₁ Teeth present in upper jaw. *Globicephalidae*
- 9₂ Teeth absent in upper jaw. *Grampidae*

ICR

一般財団法人 日本鯨類研究所
THE INSTITUTE OF CETACEAN RESEARCH

STUDIES ON THE LIPIDS IN BRAIN OF BLACK RIGHT WHALE IN THE NORTHERN PACIFIC OCEAN

HIDEO TSUYUKI* AND UHEI NARUSE**

INTRODUCTION

There have been many works on lecithin contained in the brain of human and mammal living on land as well as on lecithin in the egg of hen. The works on lecithin in the brain of human and mammal were reported by Yokoyama & Suzuki (1932 ab) and Levene & Rolf (1921, 1922). Reviewing the works on lecithin in the brain of sea mammal, Igarashi & Zama (1955) studied on lecithin in the brain of sperm whale (*Physeter catodon*) and Alaskan pollock (*Theragra chalcogramma*).

According to the works of Igarashi & Zama (1955), the characteristics of the lecithin in the brain of sperm whale was as follows: Iodine value 71.5, Nitrogen content 1.68%, Phosphorus content 3.61%, Choline content 14.4%. Further the presence of palmitic, stearic, oleic and eicosatetraenoic acids was confirmed and the presence of C₂₀, C₂₂, and C₂₄ acids as saturated fatty acids and C₂₀ monoenoic acid as unsaturated fatty acids were presumed as the component fatty acids of the lecithin.

In the present work, the writers have studied the properties of the acetone-soluble lipid and phospholipids in the brain of the black right whale in the Northern Pacific Ocean.

It is pleasure that the writers express here their sincere thanks to Dr. Hideo Omura and Dr. Akio Shionoya for their kind advices and thanks to Mr. Seiji Ohsumi who had kindly them the frozen brain of the black right whale.

EXPERIMENTS AND RESULTS

The operation such as the distillation and concentration of solvents were taken in atmosphere of nitrogen gas. Iodine value was measured by Wijs' method, N content by micro-Kjeldahl method, P by method of Beveridge & Johnson (1958), ethanolamine and serine by method of Levine & Chargaff (1951), choline by Glick's method (Glick, 1944) and inositol by method of Böhm & Picharz (1954).

1. Material

Material is the frozen brain of the black right whale, *Eubalaena glacialis* (male, body length: 15.1 m, presumed age: more than 9 years old) which was caught in the southern sea of Kojak Island in the Northern Pacific Ocean (N: 55°53'-54', W: 154°4'-6').

* Department of Food Engineering, College of Agriculture & Veterinary Medicine, Nihon University, 49, 3-chome, Shimouma-cho, Setagaya, Tokyo.

** Dept. of Fisheries, Coll. of Agr. & Vet. Med., Nihon Univ.

2. Preparation of Acetone-Soluble Lipid and Phospholipids

The acetone-soluble fraction was 5 times extracted from 500 g of the frozen brain with 5 weights of acetone, and the obtained acetone-soluble fraction was 3 times extracted with 5 weights of ethyl-ether. Then ethyl-ether was distilled off from the ethyl-ether extract and the acetone-soluble lipid was obtained from the 500 g of the frozen brain. The properties of the acetone-soluble lipid are shown in Table 1.

TABLE 1. PROPERTIES OF ACETONE-SOLUBLE LIPID IN BRAIN OF BLACK RIGHT WHALE

Yield		N _D ²⁰	Acid value	Sapon. value	Iodine value	Unsapon. matter(%)
g	%*					
6.3	1.26	1.4765	2.6	183.1	142.1	1.37
Phosphorus (%)	Nitrogen (%)	Choline (%)	Ethanolamine (%)	Serine (%)	Inositol (%)	Sterol** (%)
0.03	0.02	0.01	0.01	0.02	trace	18.62

* % of acetone-soluble lipid from the frozen brain.

** % of sterol in unsaponifiable matter by digitonin method.

The residue obtained after extracting the acetone-soluble lipid from the brain and the residue after extracting ethyl-ether-soluble fraction from the acetone-soluble fraction were mixed, and the mixture was 5 times extracted with 5 weights of chloroform-methanol solution (2:1). The extract was 3 times treated by the washing of Folch, Ascoli, Lees, Mexth & Lebaron (1951), and the chloroform layer was separated and then chloroform was distilled off from the layer. Thus the phospholipids were obtained. After all 2.1 g of phospholipids was obtained from the material (Fig. 1). The properties of the phospholipids are given in Table 2.

TABLE 2. PROPERTIES OF PHOSPHOLIPIDS IN BRAIN

Yield		Phosphorus (%)	Nitrogen (%)	Choline (%)	Ethanolamine (%)	Serine (%)
g	%*					
2.1	0.42	3.72	1.81	4.68	4.11	3.03
Inositol (%)	N/P**	Choline/P**	Serine/P**	Ethanolamine/P**		
0.82	1.08	0.31	0.24	0.55		

* % of phospholipids from the frozen brain.

** molar ratio.

3. Component Fatty Acids of Acetone-soluble Lipid and Phospholipids

Mixed fatty acids were prepared from the acetone-soluble lipid and phospholipid in the brain of the black right whale by alkali-hydrolysis.

The mixed fatty acids obtained from the acetone-soluble lipid were separated into two portions, solid and liquid fatty acids with lead salt-ethanol fractionation of Hilditch (1956) (Table 3). After synthesizing the acetal-ester of the solid fatty acids with mono-bromo-acetone, the acetal-ester of solid fatty acids were dissolved and heated in ethanol, and a little excess volume of 2N-HCl methanol solution contained 2,4-dinitrophenylhydrazine were added to the above solution

Then 2,4-dinitrophenylhydrazone of acetal-ester was reduced by cooling this solution at the room temperature, and separated with filtration. Finally 2,4-dinitrophenylhydrazone of the acetal-ester was identified with paper chromatography as its 2% benzene solution by the method of Inoue, Hirayama & Noda (1956 a). The results are shown in Table 4. The other hand the liquid fatty acids were con-

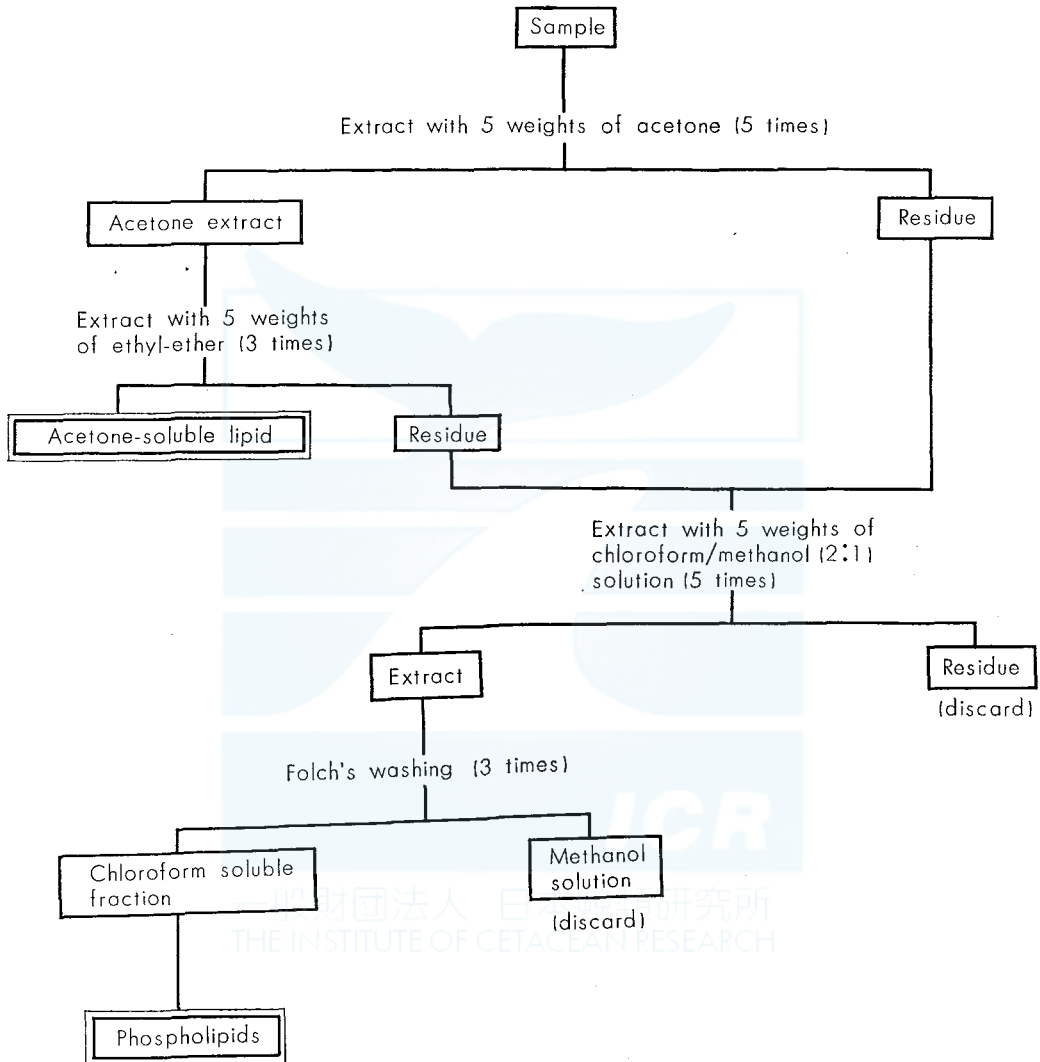

Fig. 1. Extraction and fractionation of lipids from brain of black right whale.

verted into the methyl ester of the fatty acids by the usual method. Mercuric acetate was added to the methyl ester of the fatty acids in methanol by method of Noda, Hirayama & Inoue (1956), and the liquid fatty acids were identified with

paper chromatography as their mercuric acetate complexes of methyl ester (Table 5).

TABLE 3. FRACTIONATION OF MIXED FATTY ACIDS OBTAINED FROM ACETONE-SOLUBLE LIPID

Kinds of fatty acids	%	Neutr. value	Iodine value
Mixed fatty acids	—	191.8	151.2
Solid fatty acids	38.6	200.2	10.3
Liquid fatty acids	61.4	183.4	200.3

TABLE 4. R_F VALUE OF 2,4-DINITROPHENYLHIDRAZONES OF ACETAL ESTER OF COMPONENT SATURATED ACIDS OF ACETONE-SOLUBLE LIPID

Sample	Acid				
	Myristic	Palmitic	Stearic	Arachidic	Behenic
Acetone soluble lipid	—	0.29	0.22	0.15	0.10
Standard	0.35	0.29	0.23	0.16	0.11

Paper: Tōyō No. 2. Moving phase: methanol—acetic acid—tetralin (10:2:1).
Stationary phase: Tetralin. Development: Ascending at 30°C. Detection: N/2 KOH in ethanol.

TABLE 5. R_F VALUE OF MERCURIC ACETATE COMPLEXES OF METHYLESTER OF COMPONENT LIQUID ACIDS OF ACETONE-SOLUBLE LIPID

Sample	Acid					
	Zoomaric	Oleic	Eicosenoic	Erucic	Linoleic	Linolenic
Acetonesoluble lipid	0.26	0.14	0.09	0.05	0.51	0.70
Standard	0.25	0.16	0.09	0.05	0.52	0.71

Stationary and moving phase were the same as shown in Table 4. Detection: 0.2% dinitrocarbazone in ethanol.

While para-bromophenacyl bromide were added into the methanol solution contained 20mg of the mixed fatty acids (Table 6) separated from the phospholipids, and the solution was heated for two hours in water bath and then cooled, 2N-HCl methanol solution contained 1% 2,4-dinitrophenylhydrazine was added into the above cooled solution, and the solution was set on for 3 hours at room temperature.

TABLE 6. PROPERTIES OF MIXED FATTY ACIDS OBTAINED FROM PHOSPHOLIPIDS

%	Neutralization value	Iodine value
62.38	155.3	190.1

Thus para-bromophenacyl-ester-2,4-dinitrophenylhydrazine of the fatty acids was synthesized. This ester was extracted with ether. After the extracted solution was washed with water, the water in the solution was removed with anhydrous sodium sulfate and the ether solution was divided into two portions. After each portion of the ether solution was concentrated to 1 ml, anhydrous methanol solution contained mercuric acetate was added to one portion. The solution was heated for 40 minutes at 40°C and cooled. Then 1 ml of benzene, 10ml of water and one

drop of acetic acid were added into the above solution, the benzene-ether solution was produced on the upper layer. This solution was called as Sample B. To another portion, benzene, water and acetic acid were added by the same method mentioned above except mercuric acetate, thus sample A was prepared. The sample A and B of complexes of fatty acids were treated with paper chromatography of Inoue, Hirayama & Noda (1956 b.) R_f value of the sample A and B are shown in Table 7 and 8.

TABLE 7. R_f VALUE OF SAMPLE A OF MIXED FATTY ACIDS OBTAINED FROM PHOSPHOLIPIDS BY BROMOZONE METHOD.

Sample	Acid					
	Myristic	Palmitic	Stearic	Arachidic	Behenic	Oleic
Phospholipids	0.34	0.27	0.23	0.18	—	0.25
Standard	0.35	0.29	0.23	0.17	0.12	0.26

Paper: Tōyō No. 2 (40×40 cm). Stationary phase: Petroleum hydrocarbon (b.p. 140–170°C). Moving phase: Methanol-Acetic acid-Petroleum hydrocarbon (5:1:1). Ascending at 30°C. for 5 hours.

TABLE 8. R_f VALUE OF SAMPLE B OF MIXED FATTY ACIDS OBTAINED FROM PHOSPHOLIPIDS BY BROMOZONE METHOD

Sample	Acid					
	Zoomaric	Oleic	Eicosenoic	Erucic	Linoleic	Linolenic
Phospholipids	0.55	0.51	0.46	0.41	0.73	0.68
Standard	0.57	0.51	0.47	0.39	0.72	0.69

Paper, ascending method, stationary and moving phase were the same as shown in Table 7.

4. Silica Gel Column Chromatography and Silicic Paper Chromatography of Phospholipids

Phospholipids in the brain of black right whale were fractionated with silica gel column by Rhodes' method (Rhodes & Dawson, 1960). At first, 40 g of silica gel (Kanto-kagaku Co.) being suspended in methanol, the silica gel-methanol solution was poured into glass column filled with glass-fiber for chromatography (30×1.7 cm), and set until the silica gel was sunk down. Then the solution was flowed down by opening the glass cock of the column. Directly before the surface of the solution reached to the top of silica gel column, the column was washed with 2 volumes of chloroform. When 2–3ml of chloroform was remained on the top of the silica gel column, the cock was closed. Next, the chloroform solution contained 100 mg of phospholipids was added into the column mentioned above. Various phospholipids were eluted with various methanol-chloroform solvents (Table 9). The properties of each phospholipid are shown in Fig. 2 and Table 10.

Moreover, the phospholipids were treated with silicic paper chromatography (Rhodes & Dawson, 1960) to separate each phospholipid. After the filter paper for chromatography (Toyo No. 51) was immersed in sodium silicate solution (sodium silicate: water/1:1) for 5 minutes, the paper was suspended in air for 5 minutes and the excess solution was removed from the paper. Further the paper

TABLE 9. SOLVENTS FOR FRACTIONATION OF PHOSPHOLIPIDS

Chloroform : Methanol	Volume (ml)	Kinds of phospholipids
90 : 10	25	Polyglyceric acid
80 : 20	15	Phosphatidyl serine and Phosphatidyl ethanolamine
75 : 25	50	Phosphatidyl ethanolamine
60 : 40	25	Monophosphoinositide
50 : 50	75	Phosphatidyl choline
10 : 90	25	Sphingomyelin and phosphatidyl choline

is im
ashed
erni
ared
eat

TABLE 10. PROPERTIES OF EACH FRACTION OBTAINED FROM PHOSPHOLIPIDS BY SILICA GEL COLUMN CHROMATOGRAPHY

Component	Fraction					
	1	2	3	4	5	6
Phosphorus (%)	3.31	3.72	3.70	3.34	3.36	3.67
Nitrogen (%)	0.23	1.62	1.61	0.39	1.66	3.34
Choline (%)	—	—	—	—	12.40	11.30
Ninhydrin	—	+	+	+	+	+
Inositol	—	—	—	+	+	—
N/P*	0.15	0.95	0.96	0.25	0.99	2.01
Choline/P*	—	—	—	—	0.87	0.83

As
fig
an
se
of
li
c
l

* Molar ratio

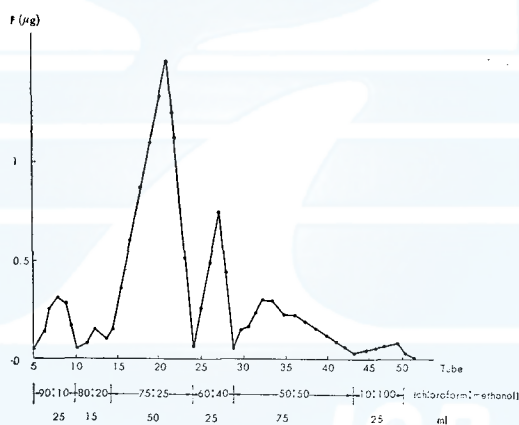

Fig. 2. Silicic column chromatography of phospholipids.

TABLE 11. R_F VALUE OF PHOSPHOLIPIDS BY SILICIC PAPER CHROMATOGRAPHY

Component	Standard	Sample
Phosphatidic acid	0.72	—
Phosphatidyl ethanolamine	0.56	0.54
Phosphatidyl serine	0.52	0.51
Phosphatidyl choline	0.33	0.33
Sphingomyelin	0.23	0.22
Inositol phosphatide	0.20	0.18

Development: di-isobutylketone : acetic acid : water (40 : 25 : 5), ascending at room temperature for 12 hours.

Detection: all lipids—rhodamin 6G, phosphatidyl choline and sphingomyelin—molibdic phosphate, phosphatidyl ethanolamine and phosphatidyl serine—ninhydrin, inositol phosphatide—Elson-Morgan reagent.

was immersed in dilute HCl solution for 30 minutes. Then the paper was 5 times washed with water in order to remove the HCl. After setting the paper in air overnight, the paper was dried for one hour at 110°C. The silicic paper was prepared by the process above mentioned. The result of chromatography which was treated with this silicic paper was shown in Table 11.

DISCUSSION

As has been shown in Table 1, the acetone-soluble lipid in the brain of the black right whale contained a trace of nitrogen, phosphorus, choline, ethanolamine, serine and its acid value and unsaponifiable matter content were lower. Therefore it seems that the main constituent of acetone-soluble lipid is glyceride, and the contents of free fatty acid and unsaponifiable matter are little. The yield of acetone-soluble lipid was 1.26% to the frozen brain of the whale, and was comparatively lower. The content of sterol in unsaponifiable matter was 18.62%. The paper chromatography by the method of Inoue, Hirayama & Noda (1956 a) and Noda, Hirayama & Inoue (1956), indicated that palmitic, stearic, arachidic and behenic acids as saturated fatty acids, and zoomalic, oleic, eicosenoic, erucic, linoleic and linolenic acids as unsaturated fatty acids were contained in the acetone-soluble lipid (Table 4, 5). Myristic acid was unable to be found in the acetone-soluble lipid in the brain.

The yield of phospholipids obtained from the brain of the whale was 0.42%. The properties of the phospholipids were as follows: choline content 4.68%, ethanolamine content 4.11%, serine content 3.03% and inositol content 0.82% (Table 2). According to the bromozone method of Inoue, Hirayama & Noda (1956 b), component fatty acids of the phospholipids seemed to be myristic, palmitic, stearic and arachidic acids as saturated fatty acids, and zoomaric, oleic, eicosenoic, erucic, linoleic and linolenic acids as unsaturated fatty acids. However, the presence of behenic acid was not able to be found in the phospholipids.

When the component fatty acids of the acetone-soluble lipid and phospholipids were compared, the presence of palmitic, stearic and arachidic acids were found in both lipids in the case of saturated fatty acids, but myristic acid was not contained in the acetone-soluble lipid and behenic acid was not able to be found in the phospholipids. Considering of the component unsaturated fatty acids, their component acids were common to both lipids and the presence of zoomaric, oleic, eicosenoic, erucic, linoleic, linolenic acids were observed in the case of both lipids. Perhaps, various component unsaturated fatty acids seemed to be contained in phospholipids in the whale brain. The results of silica gel column chromatography by Rhodes' method indicated the presence of phosphatidyl ethanolamine, phosphatidyl serine, phosphatidyl choline, sphingomyelin and inositol phosphatide was observed in the phospholipids. But phosphatidic acid was not able to found in the phospholipids (Table 11).

SUMMARY

1) The characteristics of the acetone-soluble lipid and phospholipids in the brain of black right whale in the Northern Pacific Ocean were studied.

2) The yield of acetone-soluble lipid obtained from the frozen brain was 1.26% and sterol content in unsaponifiable matter was 18.62%. The results of paper chromatography by the methods of Inoue, Hirayama & Noda (1956 a) and Noda, Hirayama & Inoue (1956) indicated that the presence of palmitic, stearic, arachidic, zoomaric, oleic, eicosenoic, erucic, linoleic and linolenic acids in the acetone-soluble lipid.

3) The yield of phospholipids obtained from the frozen brain was 0.42%. The results of the bromozone method indicated the presence of myristic, palmitic, stearic, arachidic, zoomaric, oleic, eicosenoic, erucic, linoleic and linolenic acids in the phospholipids.

The results obtained by the silica gel column chromatography and silicic paper chromatography indicated the presence of phosphatidyl ethanolamine, phosphatidyl choline, inositol phosphatide, polyglyceric acid, phosphatidyl serine and sphingomyelin in the phospholipids.

REFERENCES

- BEVERIDGE, J.M.R. & JOHNSON, S.E. (1958). "Biochemistry of Lipid", Kyoritsu-Syuppan Co. Tokyo, 311.
- BÖHM, P. & G. PICHARZ (1954). Von Quantitative Bestimmung Von Inosit in Phosphstiden, *Z. Physiol. Chem.*, 298: 110-120.
- FOLCH, J., I. ASCOLI, M. LEAS, J.A. MEXTH & F.M. LEBARON (1951). Preparation of Lipide Extracts from Brain Tissue, *J. Biol. Chem.*, 191: 833-841.
- GLICK, D. (1944). Concerning the Reineckate Method for the Determination of Choline, *J. Biol. Chem.*, 156: 643-651.
- HILDITCH, T.P. (1956). "The Chemical Constitution of Natural Fats (3rd. ed.)" Champan & Hall, London, 574.
- IGARASHI, H. & ZAMA, K. (1955). Studies on the Phosphatide of Aquatic Animals. Part 2. *Nippon NogeikagakuKaishi*, 29: 958, 961.
- INOUE, Y., HIRAYAMA, O. & NODA, M. (1956·a). Paper Chromatography of Fatty Acids as their Acetal Ester Derivatives, *J. Japan Oil Chemists' Soc.*, 5: 16.
- (1956·b). Separation and Identification of Fatty Acids. Part XX. *Bull. Agr. Chem. Soc. Japan*. 20: 200-205.
- LEVENE, P.A. & ROLF, I.P. (1921). Lecithine 4-Lecithine of the Brain, *J. Biochem.* 46: 353-65.
- (1922). Unsaturated Fatty Acids of the Brain Lecithines, *J. Biochem.* 54: 99-100.
- LEVINE, C. & E. CHARGAFF. (1951). Chromatographic Behavior of Analogues of the Nitrogenous Lipide Constitutes, *J. Biol. Chem.*, 192: 481-483.
- NODA, M., HIRAYAMA, O. & INOUE, Y. (1956). Separation and Identification of Fatty Acids, Part XIX. *Nippon NogeikagakuKaishi*, 30: 106-111.
- RHODES, D.N. & DAWSON, R.M.C. (1960). "Chromatographic and Electrophoretic Technique 1." 363 p. New York.
- YOKOYAMA, Y. & SUZUKI, B. (1932·a). Phospholipids in Human Brain-2, *P.I.A. Japan* 8: 375-60.
- (1932·b). Phospholipids in Human Brain-3, *P.I.A. Japan*, 8: 361-3.

THE SCIENTIFIC REPORTS OF THE WHALES RESEARCH
INSTITUTE, TOKYO, JAPAN

NUMBER 1, JUNE 1948

- Akiya, S. and Tejima, S. Studies on Digestive Enzyme in Whale. 3-7
Akiya, S., Ishikawa, Y., Tejima, S. and Tanazawa, T. Studies on Trypsin from a Whale (*Balaenoptera borealis* L.) 8-10
Akiya, S., Tejima, S. and Ishikawa, Y. Studies on the Utilization of Whale Meat by the use of Pancreatic Trypsin of Whales. 11-14
Akiya, S. and Kobo, F. The Test Culture of Some Microorganisms with Whale Meat Peptone. 15-16
Nakai, T. Chemical Studies on the Freshness of Whale Meat. I. Evaluation of Freshness and Changes in Quantity of Several Kinds of Nitrogen in Whale Meat Following Deterioration of Freshness. 17-26
Nakai, T. Chemical Studies on the Freshness of Whale Meat. II. On Comparison between Whale Meat and Beef on Deterioration of Freshness and Autolysis. 27-30
Tawara, T. On the Simultaneous Extraction of Vitamin A-D and Vitamin B₂ Complex from the Liver of a Fin Whale (Nagasaki-Kujira, *Balaenoptera physalus* L.). 31-37
Tawara, T. Studies on Whale Blood. I. On the Separation of Histidine from Whale Blood. 38-40
Nakai, J. and Shida, T. Sinus-hairs of the Sei-Whale (*Balaenoptera-borealis*). 41-47

NUMBER 2, DECEMBER 1948

- Ogawa, T. and Arifuku, S. On the Acoustic System in the Cetacean Brains. 1-20
Yamada, M. Auditory Organ of the Whalebone Whales. (Preliminary Report). 21-30
Nakai, T. Chemical Studies on the Freshness of Whale Meat. III. Effect of Hydrogen-ion Concentration on Decrease in Freshness and Titration Curve of Whale Meat with HCl and Na₂CO₃. 31-34
Ishikawa, S., Omote, Y. and Soma, Y. Analytical Distillation of Vitamin A in the Whale Liver Oil. 35-41
Ishikawa, S., Omote, Y. and Kanno, H. Molecular Distillation of Sperm Whale Blubber Oil. 42-45
Kaneko, A. Molecular Distillation of Fin Whale Liver Oil. 46-50
Akiya, S. and Takahashi, K. Determination of Tryptophan in Whale Meat. 51-54
Ishikawa, Y. and Tejima, S. Protein Digestive Power of Sperm Whale Pancreatic Enzyme. 55-60
Tsukamoto, S. Experiment on Digestion of Whale Meat by Koji-mould. 61-66

NUMBER 3, FEBRUARY 1950

- Ogawa, T. and Shida, T. On the Sensory Tubercles of Lips and of Oral Cavity in the Sei and the Fin Whales. 1-16
Ohe, T. Distribution of the Red Marrow in Bones of the Fin Whale. 17-22
Hosokawa H. On the Cetacean Larynx, with Special Remarks on the Laryngeal Sack of the Sei Whale and the Aryteno-Epiglottidal Tube of the Sperm Whale. 23-62
Akiba, T., Tsuchiya, T., Umehara, M. and Natsume, Y. Bacteriological Studies on Freshness of Whale Meat. (Report No. 1). 63-70
Ishikawa, Y. Protein Digestive Power of Sperm Whale Pancreatic Enzyme. II. 71-78
Mori, T. and Saiki, M. Properties of Fats and Oils Contained in Various Parts of a Sperm Whale Body. 79-84
Tawara, T. and Fukazawa, R. Studies on Kitol. I. Preparation of Kitol from Whale Liver Oil. 85-88
Tawara, T. and Fukazawa, R. Studies on Kitol. II. Influence of Kitol Fraction on the Determination of the International Unit of Vitamin A. 89-91
Tawara, T. and Fukazawa, R. Studies on Kitol. III. The effect of Sunlight, Air and Heat on the Vitamin A and Kitol Fractions. 92-95

- Tawara, T. On the Respiratory Pigments of Whale (Studies on Whale Blood II.) 96-101
 Yoshida, M. Research on Methionine in Whale. 102-105
 Mizue, K. Factory Ship Whaling Around Bonin Islands in 1948. 106-118
 Mizue, K. and Jimbo, H. Statistic Study of Foetuses of Whales. 119-131
 Nishiwaki, M. and Hayashi, K. Biological Survey of Fin and Blue Whales Taken in the Antarctic Season 1947-48 by the Japanese Fleet. 132-190

NUMBER 4, AUGUST 1950

- Omura, H. On the Body Weight of Sperm and Sei Whales located in the Adjacent Waters of Japan. 1-13
 Omura, H. Diatom Infection on Blue and Fin Whales in the Antarctic Whaling Area V (the Ross Sea Area). 14-26
 Omura, H. Whales in the Adjacent Waters of Japan. 27-113
 Nishiwaki, M. Determination of the Age of Antarctic Blue and Fin Whales by the Colour Changes in Crystalline Lens. 115-161
 Nishiwaki, M. Age Characteristics in Baleen Plates. 162-183
 Nishiwaki, M. On the Body Weight of Whales. 184-209

NUMBER 5, JUNE 1951

- Akiba, T., Umehara, M. and Natsume, Y. Bacteriological Studies on Freshness of Whale Meat. (Report No. II). 1-4
 Hosokawa, H. On the Pelvic Cartilages of the Balaenoptera-Foetuses, with Remarks on the Specific and Sexual Difference. 5-15
 Ohe, T. Iconography on the Abdominal Cavity and Viscera of the Balaenoptera, with Special Remarks upon the Peritoneal Coverings. 17-39
 Akiya, S. and Hoshino, O. Isolation of Histidine from Whale Blood Using 3, 4-Dichlorobenzene Sulfonic Acid. 41-47
 Tawara, T. and Fukazawa, R. Studies on Kitol. IV. Purification of Kitol by Chromatographic. 49-51
 Ishikawa, S., Omote, Y. and Okuda, H. Substances Related to Vitamin A in the Whale Liver Oil. 53-59
 Ishikawa, S., Omote, Y., Kijima, M. and Okuda, H. Thermal Decomposition of Kitol. 61-69
 Mizue, K. Grey Whales in the East Sea Area of Korea. 71-79
 Mizue, K. Food of Whales (In the Adjacent Waters of Japan). 81-90
 Nishiwaki, M. and Ohe T. Biological Investigation on Blue Whales (*Balaenoptera musculus*) and Fin Whales (*Balaenoptera physalus*) Caught by the Japanese Antarctic Whaling Fleets. 91-167

NUMBER 6, DECEMBER 1951

- Hosokawa, H. On the Extrinsic Eye Muscles of the Whale, with Special Remarks upon the Innervation and Function of the Musculus Retractor Bulbi. 1-33
 Murata, T. Histological Studies on the Respiratory Portions of the Lungs of Cetacea. 35-47
 Kojima, T. On the Brain of the Sperm Whale (*Physeter catodon* L.) 49-72
 Mizue, K. and Murata, T. Biological Investigation on the Whales Caught by the Japanese Antarctic Whaling Fleets Season 1949-50. 73-131
 Nishiwaki, M. On the Periodic Mark on the Baleen Plates as the Sign of Annual Growth. 133-152
 Nishiwaki, M. and Hibiya, T. On the Sexual Maturity of the Sperm Whales (*Physeter catodon*) found in the Adjacent Waters of Japan (I). 153-165
 Nakai, T. Chemical Studies on Freshness of Whale Meat. IV. Some informations of *Achromobacter ubiquitum* isolated from Whale Carcass. 167-176
 Nakai, T. and Ono, H. The Effects of Electric Shock and Fatigue on Post-mortem Changes in Muscle. 177-185

- Omote, Y. Complete Recovery of Vitamin A from Molecular Distillation Residue of Whale-liver Oil. 187-191
- Omote, Y. Chemical Structure of Kitol (I). Double Bonds and Hydroxyl Groups. 193-198
- Hirata, M. Experimental Investigation on Flattened Head Harpoon an Attempt for Restraining Ricochet. 199-207

NUMBER 7, JULY 1952

- Ogawa, T. On the Cardiac Nerves of Some Cetacea, with Special Reference to those of *Berardius bairdii* Stejneger. 1-22
- Akiya, S., Hoshino, O. and Motohashi, N. On an Attempt to Preserve Whale Meat Freshness with 5-Nitrofurfuri-*den* Aminoguanidine from Decay. 23-30
- Akiya, S. and Sawamura, R. Colorimetric Determination of 5-Nitro-2 furfuri-*ene* Aminoguanidine. 31-36
- Tomiya, S. and Takao, M. Studies on Utilization of Higher Fatty Alcohol from Sperm Whale Oil. 37-46
- Omote, Y. A Rapid Method for the Separate Determination of Vitamin A and Kitol in the Whale-liver Oil. 47-50
- Arai, Y. and Sakai, S. Whale Meat in Nutrition. 51-67
- Yamaguchi, K. and Fujino, K. On the Serological Constitution of Striped Dolphin (*Prodelphinus caeruleo-albus* (Meyen)) (I.) 69-77
- Nishimoto, S., Tozawa, M. and Kawakami, T. Food of Sei Whales (*Balaenoptera borealis*) Caught in the Bonin Island Waters. 79-85
- Nishiwaki, M. On the Age-Determination of Mysticoceti, Chiefly Blue and Fin Whales. 87-119
- Nishiwaki, M. and Hibiya, T. On the Sexual Maturity of the Sperm Whales (*Physeter catodon*) Found in the Adjacent Waters of Japan (II). 121-124
- Ohno, M. and Fujino, K. Biological Investigation on the Whales Caught by the Japanese Antarctic Whaling Fleets, Season 1950/51. 125-188

NUMBER 8, JUNE 1953

- Yamada, M. Contribution to the Anatomy of the Organ of Hearing of Whales. 1-79
- Omura, H. Biological Study on Humpback Whales in the Antarctic Whaling Areas IV and V. 81-102
- Fujino, K. On the Serological Constitution of the Sei-, Fin-, Blue- and Humpback-Whales (I). 103-125
- Ogawa, T. On the Presence and Disappearance of the Hind Limb in the Cetacean Embryos. 127-132
- Nishiwaki, M. and Yagi, T. On the Age and the Growth of Teeth in a Dolphin, *Prodelphinus caeruleo-albus*. (I). 133-146
- Kakuwa, Z., Kawakami, T. and Iguchi, K. Biological Investigation on the Whales Caught by the Japanese Antarctic Whaling Fleets in the 1951-52 Season. 147-213
- Nishiwaki, M. Hermaphroditism in a Dolphin (*Prodelphinus caeruleo-albus*). 215-218

NUMBER 9, JUNE 1954

- Akiya, S., Hoshino, O. and Motohashi, N. Attempt to Preserve Freshness of Whale Meat with Germicides. II. 1-10
- Ogawa, T. On the Musculature of the Sinus Venosus and its Continuation with the So-called Conducting System of the Whale's Heart. 11-35
- Yamada, M. Some Remarks on the Pygmy Sperm Whale, *Kogia*. 37-58
- Yamada, M. An Account of a Rare Porpoise, *Feresa* Gray from Japan. 59-88
- Omura, H. and Fujino, K. Sei Whales in the Adjacent Waters of Japan. II. Further Studies on the External Characters. 89-103
- Fujino, K. On the Serological Constitution of the Sperm- and Baired Beaked-Whales (I) Blood Groups

- of the Sperm- and Bairied Beaked-Whales. 105-120
- Fujino, K. On the Body Proportions of the Fin Whales (*Balaenoptera physalus* (L.) Caught in the Northern Pacific Ocean (I) (Preliminary Report). 121-163
- Nishiwaki, M., Hibiya, T. and Kimura, S. On the Sexual Maturity of the Sei Whale of the Bonin waters. 165-177
- Uda, M. Studies of the Relation between the Whaling Grounds and the Hydrographical Conditions (I). 179-187

NUMBER 10, JUNE 1955

- Hosokawa, H. Cross-Section of a 12 mm. Dolphin Embryo. 1-68
- Nemoto, T. White Scars on Whales (I) Lamprey Marks. 69-77
- Omura, H. and Nemoto, T. Sei Whales in the Adjacent Waters of Japan. III. Relation between Movement and Water Temperature of the Sea. 79-87
- Omura, H., Fujino, K. and Kimura, S. Beaked Whale *Berardius bairdi* of Japan, with Notes on *Ziphius cavirostris*. 89-132
- Fujino, K. On the Body Weight of the Sei Whales Located in the Adjacent Waters of Japan (II). 133-141
- Nishiwaki, M. On the Sexual Maturity of the Antarctic Male Sperm Whale (*Physeter catodon* L.) 143-149
- Ohta, K. and Others. Composition of Fin Whale Milk. 151-167

NUMBER 11, JUNE 1956

- Omura, H. and Sakiura, H. Studies on the Little Piked Whale from the Coast of Japan. 1-37
- Nishiwaki, M., Hibiya, T. and Kimura, S. On the Sexual Maturity of the Sperm Whale (*Physeter catodon*) Found in the North Pacific. 39-46
- Fujino, K. On the Body Proportions of the Sperm Whales (*Physeter catodon*). 47-83
- Fujino, K. On the Serological Constitution of the Fin Whales II. Further Studies on Blood Groups. 85-98
- Nemoto, T. On the Diatoms of the Skin Film of Whales in the Northern Pacific. 99-132
- Hoshina, T. and Sugiura, Y. On a Skin Disease and a Nematode Parasite of a Dolphin, *Tursiops truncatus* (Montagu, 1821). 133-138
- Iwai, E. Descriptions on Unidentified Species of Dibranchiate Cephalopods. I. An Oegopsiden Squid belonging to the Genus *Architeuthis*. 139-151
- Iwai, E. Descriptions on Unidentified Species of Dibranchiate Cephalopods. II. A Cranchiidae Squid of the Genus *Taonius*. 153-161
- Uda, M. and Nasu, K. Studies of the Whaling Grounds in the Northern Sea-Region of the Pacific Ocean in Relation to the Meteorological and Oceanographic Conditions. (Part I). 163-179
- Kimura, S. and Nemoto, T. Note on a Minke Whale Kept Alive in Aquarium. 181-189
- Ishikawa, Y. A Characteristic Property of Whale Oils concerning the Absorption of Gases. I. On the Absorption of Carbon Dioxide by Whale Oils. 191-213

NUMBER 12, JUNE 1957

- Omura, H. Osteological Study of the Little Piked Whale from the Coast of Japan. 1-21
- Nishiwaki, M. Age Characteristics of Ear Plugs of Whales. 23-32
- Nemoto, T. Foods of Baleen Whales in the Northern Pacific. 33-89
- Nasu, K. Oceanographic Conditions of the Whaling Grounds in the Waters Adjacent to Aleutian Islands and the Bering Sea in Summer of 1955. 91-101
- Kimura, S. The Twinning in Southern Fin Whales. 103-125
- Ishihara, T. An Application of Linear Discriminant Function to External Measurements of Fin Whale. 127-189

- Nishiwaki, M. Very Small Embryo of Cetacea. 191-192
 Nishiwaki, M. One-eyed Monster of Fin Whale. 193-195
 Ogawa, T. and Kamiya, T. A Case of the Cachalot with Protruded Rudimentary Hind Limbs. 197-208
 Uda, M. and Dairokuno, A. Studies of the Relation between the Whaling Grounds and the Hydrographic Conditions. (II) A study of the Relation between the Whaling Grounds off Kinkazan and the Boundary of Water Masses. 209-224
 Abe, T. Notes on Fishes from the Stomachs of Whales Taken in the Antarctic. I. *Xenocyttus nemotoi*, a New Genus and New Species of Zeomorph Fish of the Subfamily *Oreosominae* (Goode and Bean, 1895). 225-233
 Tsuyuki, H. On the Oils Contained in Various Blubbers of Northern Elephant Seal, *Mirounga angustirostris*. 235-240

NUMBER 13, SEPTEMBER 1958

- Omura, H. North Pacific Right Whale. 1-52
 Nishiwaki, M. and Kamiya, T. A Beaked Whale *Mesoplodon* Stranded at Ōiso Beach, Japan. 53-83
 Nishiwaki, M. and Handa, C. Killer Whales Caught in the Coastal Waters off Japan for Recent 10 Years. 85-96
 Ohsumi, S. (Kimura) Nishiwaki, M. and Hibiya, T. Growth of Fin Whale in the Northern Pacific. 97-133
 Nishiwaki, M., Hibiya, T. and Ohsumi, S. (Kimura). Age Study of Sperm Whale Based on Reading of Tooth Laminations. 135-153
 Nishiwaki, M., Ichihara, T. and Ohsumi, S. (Kimura). Age Studies of Fin Whale Based on Ear Plug. 155-169
 Fujino, K. On the Serological Constitution of Fin Whale III. Human B Blood Group Substances in Erythrocytes and Some Notes on Anti-fin Ju Specific Antibodies. 171-184
 Nemoto, T. *Cocconeis* Diatoms Infected on Whales in the Antarctic. 185-191.
 Nemoto, T. and Nasu, K. *Thysanoessa macrura* as a Food of Baleen Whales in the Antarctic. 193-199
 Ichihara, T. Gray Whale Observed in the Bering Sea. 201-205
 Ohsumi, S. (Kimura). A Descendant of Moby Dick or a White Sperm Whale. 207-209
 Nasu K. Deformed Lower Jaw of Sperm Whale. 211-212
 Omura, H. Note on Embryo of Baird's Beaked Whale. 213-214
 Uda, M. and Suzuki, N. Studies of the Relation between the Whaling Grounds and the Hydrographic Conditions. III. 215-229
 Seki, Y. Observations on the Spinal Cord of the Right Whale. 231-251
 Kamiya, T. How to Count the Renculi of the Cetacean Kidneys, with Special Regard to the Kidney of the Right Whale. 253-267
 Hosokawa, H. and Sekino, T. Comparison of the Size of Cells and Some Histological Formations between Whales and Man. 269-301
 Ogawa, T., Tsunoda, T. and Osawa, M. Amino Acid Composition of Whale Meat. 303-307
 Ishikawa, Y. A Characteristic Property of Whale Oils Concerning the Absorption of Gases II. On the Absorption of Nitrogen by Whale Oils. 309-321
 Tsuyuki, H. Component Fatty Acids of Northern Elephant Seal Oil. 323-332

NUMBER 14, SEPTEMBER 1959

- Omura, H. Bryde's Whales from the Coast of Japan. 1-33
 Nishiwaki, M. and Kamiya, T. *Mesoplodon stejnegeri* from the Coast of Japan. 35-48
 Nishiwaki, M. Humpback Whales in Ryukyuan Waters. 49-87
 Cushing, John E., Fujino, K. and Takahashi, K. Glycerol-freezing Technique as an Aid in Blood Typing of Whales. 89-100
 Fujino, K. and Cushing, John E. Blood Typing of Dried Whale Erythrocytes with ¹³¹I Labelled Antibody. 101-106

- Ichihara, T. Formation Mechanism of Ear Plug in Baleen Whales in Relation to Glove-finger. 107-135
 Nasu, K. Surface Water Condition in the Antarctic Whaling Pacific Area in 1956-57. 137-143
 Ohsumi, S. (Kimura). A Deformed Fin Whale Fetus. 145-147
 Nemoto, T. Food of Baleen Whales with Reference to Whale Movements. 149-290
 Yamada, M. and Yoshizaki, F. Osseous Labyrinth of Cetacea. 291-304
 Nakai, T. Distribution of Amino Acid in Proteins from Various Parts of Whale Body. 305-326

NUMBER 15, NOVEMBER 1960

- Nishiwaki, M. Ryukyuan humpback whaling in 1960. 1-16
 Ohsumi, S. Relative growth of the fin whale, *Balaenoptera physalus* (Linn.). 17-84
 Fujino, K. Immunogenetic and marking approaches to identifying subpopulations of the North Pacific Whales. 85-142
 Nasu, K. Oceanographic investigation in the Chukchi sea during the summer of 1958. 143-158
 Tokita, K. and ECG Research Group. Electrocardiographical studies on Bottlenosed dolphin (*Trusiops truncatus*). 159-165

NUMBER 16, MARCH 1962

- Omura, H. Bryde's whales occurs on the coast of Brazil. 1-5
 Omura, H. Further information on Bryde's whales from the coast of Japan. 7-18
 Nishiwaki, M. Ryukyuan whaling in 1961. 19-28
 Nemoto, T. A secondary sexual character of fin whales. 29-34
 Omura, H., Nishiwaki, M., Ichihara, T. and Kasuya, T. Osteological note of a sperm whale. 35-45
 Ichihara, T. Prenatal dead foetus of baleen whales. 47-60
 Nishiwaki, M. *Mesoplodon bowdoini* stranded at Akita beach, Sea of Japan. 61-77
 Nishiwaki, M. Observation on two mandibles of Mesoplodon. 79-82
 Sinclair, John. An early dolphin embryo (*Stenella caeruleoalba*) in serial sections. 83-87
 Nemoto, T. Food of ballen whales collected in recent Japanese antarctic whaling expeditions. 89-103
 Uda, M. Subarctic oceanography in relation to whaling and salmon fisheries. 105-119

NUMBER 17, FEBRUARY 1963

- Nishiwaki, M., Ohsumi, S. and Maeda, Y. Change of form in the sperm whale accompanied with growth. 1-14
 Ohsumi, S., Kasuya, T. and Nishiwaki, M. The accumulation rate of dentinal growth layers in the maxillary tooth of the sperm whale. 15-35
 Ichihara, T. Photometric method for counting laminae in ear plug of baleen whale. 37-48
 Yoshikawa, T. and Suzuki, T. The lamination of the masseter of the humpback whale. 49-52
 Fujino, K. Intra-uterine selection due to maternal-foetal incompatibility of blood type in the whales. 53-65
 Cushing, J. E., Fujino, K. and Calaprice, N. The Ju blood typing system of the sperm whales and specific soluble substances. 67-77
 Nemoto, T. New records of sperm whales with protruded rudimentary hind limbs. 79-81
 Nemoto, T. and Nasu, K. Stones and other aliens in the stomachs of sperm whales in the Bering Sea. 83-91
 Nishiwaki, M. Taxonomical consideration on *Genera of Delphinidae*. 93-103
 Nasu, K. Oceanography and whaling ground in the subarctic region of the Pacific Ocean. 105-155
 Nemoto, T. Some aspect of the distribution of *Calanus cristatus* and *C. plumchrus* in the Bering and its neighbouring waters, with reference to the feeding of baleen whales. 157-170
 TSUYUKI, H. and Naruse, U. Studies on the oil of black right whale in the northern Pacific Ocean. 171-190
 Yagi, T., Nishiwaki, M. and Nakajima, M. A preliminary study on method of time marking with lead-salt and tetracycline on the teeth of northern fur seal. 191-195

NUMBER 18, MARCH 1964

- Fujino, K. Fin whale subpopulations in the Antarctic whaling areas II, III and IV. 1-28
- Ichihara, T. Prenatal development of ear plug in baleen whales. 29-48
- Ohsumi, S. Examination on age determination of the fin whale. 49-88
- Nemoto, T. School of baleen whales in the feeding areas. 89-110
- Okutani, T. & Nemoto, T. Squids as the food of sperm whales in the Bering Sea and Alaskan Gulf. 111-122
- Ohsumi, S. Comparison of maturity and accumulation rate of corpora albicantia between the left and right ovaries in Cetacea. 123-148
- Omura, H. A systematic study of the hyoid bones in the baleen whales. 149-170
- Nishiwaki, M. Revision of the article "Taxonomical consideration on genera of *Delphinidae*" in No. 17. 171-172
- Tsuyuki, H. & Naruse, U. Studies on the lipids in brain of black right whale in the northern Pacific Ocean. 173-180



一般財団法人 日本鯨類研究所
THE INSTITUTE OF CETACEAN RESEARCH



昭和 39 年 3 月 20 日 印刷
昭和 39 年 3 月 30 日 発行

編輯者 財団法人 日本捕鯨協会
鯨類研究所
東京都中央区月島西河岸通12丁目4番地

編輯責任者 大 村 秀 雄

印刷者 小 酒 井 益 三 郎
東京都新宿区神楽坂1丁目2番地

印刷所 研究社印刷株式会社
東京都新宿区神楽坂1丁目2番地

Printed by
Kenkyusha Printing Co.
Shinjuku-ku, Tokyo